

Avionics Radio Test Set 7000 (ARTS 7000)

Date: 04 May 2023



WARRANTY

Laversab Inc., warrants its products to conform to or exceed the specifications as set forth in its catalogs in use at the time of sale and reserves the right, at its own discretion, without notice and without making similar changes in articles previously manufactured, to make changes in materials, designs, finish, or specifications. Laversab Inc. warrants products of its own factory against defects of material or workmanship for a period of three years from date of sale.

Liability of Laversab Inc. under this warranty shall be limited to replacing, free of charge (FCA Sugar Land, Texas), any such parts proving defective within the period of this warranty, but Laversab Inc. will not be responsible for transportation charges, consequential or incidental damages. No liability is assumed by Laversab for damages that are caused by misuse or abuse of the product.

The warranty of Laversab Inc. is not made for products manufactured by others which are illustrated and described in Laversab catalogs or incorporated in Laversab products in essentially the same form as supplied by the original manufacturer. Warranties of the original manufacturers supplant the warranty of Laversab Inc., but, in applicable instances, the latter agrees to use its best efforts to have original suppliers make good their warranties.

COPYRIGHT NOTICE

Copyright (c) 1982-2023 by Laversab Inc. All rights reserved. The content of this manual may not be reproduced in any form by any means, in part or in whole, without the prior written permission of Laversab Inc.

DISCLAIMER

No representations or warranties are made with respect to the contents of this user's manual. Further, Laversab Inc. reserves the right to revise this manual and to make changes from time to time in the content hereof without obligation to notify any person of such revision.

WARNING

THE ARTS 7000 USES LINE VOLTAGES AND RADIO FREQUENCY SIGNALS FOR ITS OPERATION WHICH ARE POTENTIALLY DANGEROUS.

IMPROPER OPERATION OF THIS EQUIPMENT MAY RESULT IN PERSONAL INJURY OR LOSS OF LIFE. HENCE THE EQUIPMENT DESCRIBED IN THIS MANUAL SHOULD BE OPERATED ONLY BY PERSONNEL TRAINED IN PROCEDURES THAT WILL ASSURE SAFETY TO THEMSELVES, TO OTHERS AND TO THE EQUIPMENT.

BEFORE PERFORMING ANY MAINTENANCE, TURN THE POWER OFF AND DISCONNECT THE POWER CORD FROM THE POWER SOURCE.

ALWAYS USE A 3-PIN GROUNDED OUTLET AS YOUR AC POWER SOURCE.

TABLE OF CONTENTS

Warranty	2
Copyright Notice	2
Disclaimer	2
Revision History	3
WARNING	4
Notes on this document	9
Section 1: INTRODUCTION	10
Subsection 1: Description	10
Subsection 2: ARTS 7000 Outline Overview	10
Subsection 3: Key Capabilities	11
Subsection 4: Key Features	13
Section 2: Controller & User Interface	14
Subsection 1: Description of Test Controller Application	14
Subsection 2: Menu Structure & Functions	14
Section 3: ARTS 7000 Test Control Application	22
Subsection 1: Test Control Application – Normal or Demo/Training Mode	22
Subsection 2: Power up, Wi-Fi connection and Application Start	22
Subsection 3: Generic Controls and Indicators	24
Section 4: ARTS 7000 Test Control Application Menus	27
Subsection 1: The Utilities Menu	27
Subsection 2: Documentation Menu	34
Section 5: ARTS 7000 Software Updates	35
Subsection 1: Test Controller Application Software Update	35
Subsection 2: ARTS 7000 Firmware Update By Wi-Fi	35
Subsection 3: ARTS 7000 Firmware Update By USB	39
Section 6: ARTS 7000 Test Set Hardware Controls & Connections	45
Subsection 1: ARTS 7000 Test Set Hardware, Controls & Connections	45
Subsection 2: Hardware & Antenna Test Configuration	55
Subsection 3: Direct Connections and Antenna Set Up	56
Section 7: Antenna Coupler	59
Subsection 1: Antenna Coupler Description	59
Subsection 2: Antenna Coupler Setup and Operation	61
Section 8: Integrated Landing System (ILS) Operation	62

Subsection 1: ILS Operation	62
Subsection 2: ILS Test Control and Operation Details	66
Subsection 3: ILS Test Operation Active Test Control and Indicators	68
Section 9: Marker Beacon (MKR) Operation	70
Subsection 1: Mkr Beacon Operation	70
Subsection 2: Mkr Test Control Details.....	73
Section 10: ILS and MKR Operation	75
Subsection 1: ILS and Mkr Beacon Operation.....	75
Subsection 2: ILS& MKR Test Control Details.....	77
Section 11: VHF Omnidirectional Ranging (VOR) Operation	78
Subsection 1: VOR Operation	78
Subsection 2: VOR Test Control Details	82
Section 12: VHF COM Amplitude Modulation (AM)	84
Subsection 1: COM VHF AM Operation	84
Subsection 2: COM AM Test Control Details.....	88
Subsection 3: Diagnostic Tools.....	89
Section 13: VHF COM Frequency Modulation (FM).....	91
Subsection 1: COM VHF FM Operation.....	91
Subsection 2: COM FM Test Control Details	95
Section 14: COM High Frequency (HF) Single Side Band (SSB).....	98
Subsection 1: COM SSB HF Operation	98
Subsection 2: COM HF Test Control Details	102
Section 15: COM SelCal.....	105
Subsection 1: COM SelCal Operation	105
Subsection 2: COM SelCal Test Control Details.....	108
Section 16: ELT Emergency Location Transmitters	110
Subsection 1: ELT Operation	110
Subsection 2: ELT Test Screens and Test Procedure	112
Section 17: Distance Measuring Equipment (DME).....	125
Subsection 1: DME Operation.....	125
Subsection 2: DME Test Control Details	129
Section 18: Mode S Transponders.....	130
Subsection 1: MODE S Operation	130
Subsection 2: Mode S Test Guide	131

Subsection 3: MODE S Results screen.....	139
Section 19: ADS-B OUT	148
Subsection 1: ADS-B Out Operation.....	148
Subsection 2: ADS-B Out Test Guide.....	149
Subsection 3: ADS-B Out Results screen	153
Section 20: ADS-B IN	156
Subsection 1: ADS-B In Operation.....	156
Subsection 2: ADS-B In Test Guide.....	157
Section 21: ATCRBS Transponders	161
Subsection 1: ATCRBS Operation	161
Subsection 2: ATCRBS Test Guide	162
Subsection 3: ATCRBS Results screen	169
Section 22: UAT	173
Subsection 1: Activating UAT	173
Subsection 2: UAT Operation.....	173
Subsection 3: UAT ADS-B Out Test Guide	173
Subsection 4: UAT ADS-B In Test Guide	177
Subsection 5: UAT FIS-B Test Guide	182
Subsection 6: UAT TIS-B Test Guide	186
Section 23: TIS-B (1090 MHz).....	191
Subsection 1: TIS-B Operation	191
Subsection 2: TIS-B Test Guide.....	191
Section 24: Identity Check	197
Subsection 1: Identity Check Operation	197
Subsection 2: Identity Check Test Guide.....	197
Section 25: TCAS.....	200
Subsection 1: Activating TCAS.....	200
Subsection 2: TCAS Operation	200
Subsection 3: TCAS Test Guide	200
Section 26: TIS.....	209
Subsection 1: TIS Operation	209
Subsection 2: TIS Test Guide	209
Section 27: Altitude Monitoring	216
Subsection 1: Altitude Monitoring Description	216

Subsection 2: Altitude Monitoring Transponder Setup	216
Subsection 3: Altitude Monitoring Air Data Test Set Setup	218
Subsection 4: Altitude Monitoring Test Details	219
Section 28: GPS Simulator.....	223
Subsection 1: GPS Simulator Operation.....	223
Subsection 2: GPS Simulator Test Guide.....	223
Section 29: VSWR / LOSS	231
Subsection 1: VSWR / LOSS Operation	231
Subsection 2: VSWR & DTF Test Guide	231
Section 30: Distance To Fault	235
Subsection 1: Distance To Fault Operation.....	235
Subsection 2: DTF Test Guide	235
Section 31: Test Tools.....	239
Subsection 1: Test Tools Description	239
Subsection 2: Counter & Meter	239
Subsection 3: Frequency Scanner	241
Section 32: Calibration.....	244
Subsection 1: Calibration Notification	244
Appendix A: Technical Specifications	246
Appendix B: Spare Parts.....	256
Appendix C: ARTS-7000 Test Default and Frequency Settings.....	257
Appendix D: License Activation Procedure	259
Subsection 1: Items required	259
Subsection 2: ARTS-7000 License Activation Procedure.....	259

NOTES ON THIS DOCUMENT

This document is intended to be a guide to the normal operation of the ARTS 7000 Test System. This manual will explain the technical specifications, features, and functions of the ARTS 7000. It has been written as a user reference for the test set operator. It does not detail any specific test procedure or process for any aircraft or aircraft system. Every aircraft and aircraft system will require a specific test procedure. It is highly recommended that this manual is used in conjunction with the relevant aircraft or system maintenance manual that is to be tested using the ARTS 7000 Test System.

Please Note:

Throughout the manual there are warnings that are identified in **Red** as shown in an example below:

WARNING

It is extremely dangerous to generate signals during testing that are on the frequencies that are in use by local ATC. When operating the Test Set in a Navigation Mode (VOR, ILS, Mkr). Please be aware of the local navigation aid and ATC frequencies. It is the test set operator's responsibility to make sure all testing is carried out on Frequencies that will not interfere with local navigation aids or ATC resources.

This document also identifies some Hints and Tips to enhance and improve the operators testing experience and success. These Hints and Tips are identified throughout the document in **Green**. For an example see below:

Hints and Tips

When testing any Transponder, DME or TCAS, make sure the reflective paths are minimized from equipment that is in close proximity to the aircraft. Try to select a line of site between the test Set antenna and the Aircraft antenna that does not have any obstruction in front or behind the antenna being tested. For example: Ground Power Units, Aircraft Landing Gear, Aircraft Stairs, Toolboxes etc.

SECTION 1: INTRODUCTION

SUBSECTION 1: DESCRIPTION

The ARTS 7000 is highly portable, multi-function Avionics Radio Test System. The modular nature of the design allows expansion of capabilities as required. The system includes a series of built-in radio frequency generators and receivers to support common aircraft ramp test Radio Communications, ATC, and Navigation requirements. The test set can be used as an “over the air” (antenna to antenna connection) or as a direct connection (direct cable connection). Using a commercial off the shelf tablet as a handheld controller allows simple and intuitive operation to the user.

SUBSECTION 2: ARTS 7000 OUTLINE OVERVIEW

The design consists of:

- Fully integrated test solution.
- All test equipment housed within a single shock-resistant portable, wheeled transit case.
- Accessories housed within a lightweight pouch that can be attached to the main case.
- Commercial off the shelf tablet control of the test set.
- Wi-Fi control from tablet of ARTS 7000 test set using a unique ARTS 7000 self-generated Wi-Fi Network.
- Tablet operator interface specifically designed to be simple and intuitive to learn, yet powerful and customizable to allow detailed testing.
- Smart Power supply that covers all commonly available power sources:
 - Commercial and domestic A/C power supplies
 - Aircraft Power
 - Battery power
- Modular design with technology specific modules and future expansion slots.
 - Slot 1 – Module 1 Nav/Com Module (optional).
 - Slot 2 – Module 2 Pulse Module (optional).
 - Slot 3 – Module 3 VSWR / GPS Simulator (optional).
 - Slot 4 – Expansion Slot for Future capability development.
- Antenna for Nav/Com Operations.
- Antenna on tripod mount for Pulse and remote operations.
- Couplers for Pulse & GPS Operations.
- Various cables.

SUBSECTION 3: KEY CAPABILITIES

Capability of the ARTS 7000 is defined by which modules are installed in the test set. The following identifies the capabilities by module and technology group.

ARTS 7000 Nav/Com Module capabilities:

1. Communications – VHF band
2. Communications – UHF band
3. Communications – HF band
4. Communication – SelCal
5. Navigation – Instrument Landing System (ILS)
6. Navigation – Marker Beacon (Mkr)
7. Navigation – VHF Omnidirectional Ranging (VOR)
8. ELT – Emergency Location Transmitters
9. Tools – Frequency Counter
10. Tools – Power Meter
11. Tools – Frequency Scanner

ARTS 7000 Pulse Module capabilities:

1. Distance Measuring Equipment (DME)
2. Transponder – ATCRBS (Mode A & Mode C)
3. Transponder – Mode S
4. Transponder – ADS-B
5. Transponder – UAT (Optional)
6. Transponder – TIS-B
7. Transponder – Identity Check
8. Transponder – Altitude Monitoring
9. TCAS – Traffic Collision Avoidance System (Optional)

ARTS 7000 VSWR capabilities:

1. Tools – VSWR Meter
2. Tools – Distance to fault
3. Tools – S21 Gain/Loss Analyzer

ARTS 7000 GPS Simulator capabilities:

1. GPS Simulator – Fixed Position
2. GPS Simulator - Motion

ARTS 7000 Key Configuration/Capability Chart

ARTS 7000 Configuration/ Capability		Nav/Com Module	Pulse Module	VSWR Module	GPS Simulator Module
Communication	AM	Y			
	FM	Y			
	SSB/HF	Y			
	SelCal	Y			
Navigation	VOR	Y			
	ILS	Y			
	Mkr	Y			
ELT	ELT	Y			
Tools	Freq Count	Y			
	Pwr Meter	Y			
	Freq Scan	Y			
DME	DME		Y		
Transponder	ATCRBS		Y		
	Mode S		Y		
	ADSB		Y		
	TIS-B		Y		
	Alt. Mon		Y		
	UAT			Option	
TCAS	TCAS		Option		
Tools	VSWR			Y	
	DTF			Y	
	Gain Analyzer			Y	
GPS	Fixed Mode				Y
	Motion Mode				Y

SUBSECTION 4: KEY FEATURES

1. Quick setup.
2. Simple menus.
3. Easy Software updates.
4. Built in Utilities for ease of test system management and control.
5. Tablet Controller Application includes condensed Training & Operation Manual.
6. Specific, simple, and fast configuration control for all test capabilities.
7. Stored Results where Applicable – Transponder and ELT.
8. User-configurable test scenarios.
9. Preset or user-selectable test conditions.
10. Power savings: automatic power down if the test set is not used.
11. All accessories are included with the standard test system.

SECTION 2: CONTROLLER & USER INTERFACE

SUBSECTION 1: DESCRIPTION OF TEST CONTROLLER APPLICATION

The ARTS 7000 test system uses a commercial off-the-shelf tablet as a controller. The ARTS 7000 test set tablet controller is connected over a Wi-Fi network. This Wi-Fi network is generated by the ARTS test set and the tablet controller can connect to it directly.

Note: The ARTS 7000 or the Tablet controller does not need to be connected to an Internet-enabled Wi-Fi network. The ARTS 7000 uses its own private network.

The test set tablet controller is required to have the most recent ARTS 7000 application software installed.

SUBSECTION 2: MENU STRUCTURE & FUNCTIONS

The ARTS 7000 tablet controller application is a menu-driven application that allows full control of the ARTS 7000.

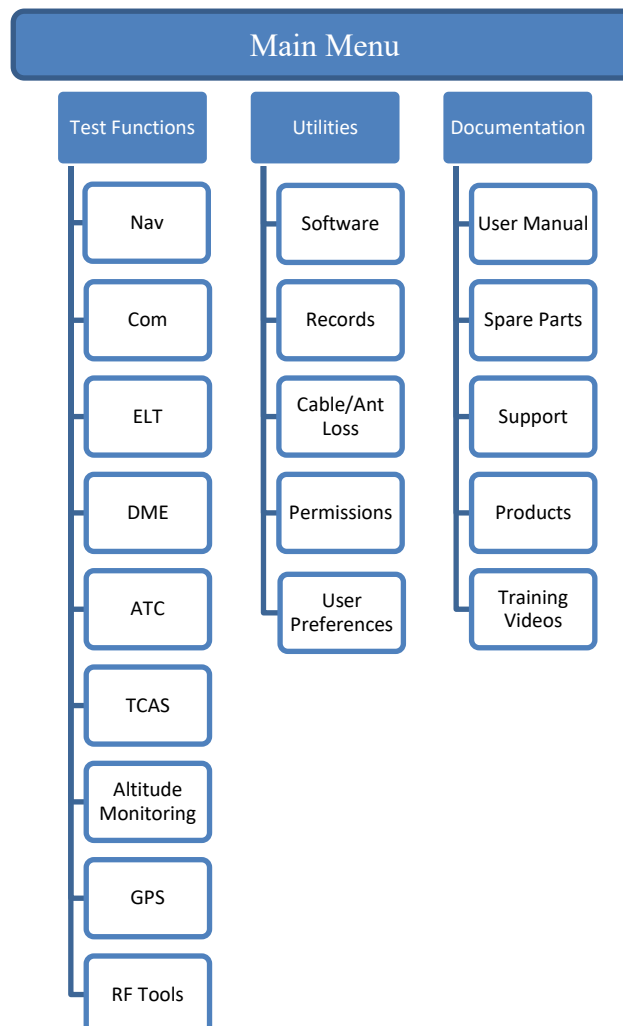

Test Functions Selections (see specific menus for details)	
Menu Item	Action / Function
NAV	Selects Navigation test capability menu.
COM	Selects Communications test capability menu.
ELT	Selects Emergency Location Transmitter (ELT) test capability menu.
DME	Selects Distance Measuring Equipment (DME) test capability menu.
ATC	Selects ATC Transponder test capability menu.
TCAS	Selects TCAS test capability Menu.
Alt. Monitoring	Selects the Altitude Monitoring (ADTS integration) test.
GPS	Selects the GPS Simulator test.
RF Tools	Selects the RF Tools test menu.

Utilities Menu	
Menu Item	Action / Function
Software	Indicates the current version of software installed on control tablet and firmware installed on ARTS 7000 Test Set.
Records	Opens the records page that displays all test records where applicable.
Cable/Ant Loss	Stores the losses of each cable and antenna – only updated if cables/antenna are changed or after a system calibration.
Permissions	Interface to add/remove and display software licenses.
User Preferences	Allows top-level user to limit changes to the functions by the operating technician.

Documentation Menu	
Menu Item	Action / Function
User Manual	Opens the ARTS 7000 User Manual.
Spare Parts	Reference to all accessories & spare parts relevant during field operations.
Support	Enables user to submit a support request (requires internet access).
Training Video	Online training videos for each capability (requires internet access).
Products	Connects to Laversab Aviation product catalog.

Navigation Menu

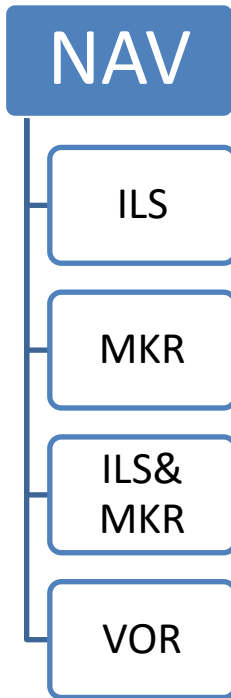

Selects the Instrument Landing System (ILS) capability test page.

Selects the Marker Beacon test page.

Selects the combined Instrument Landing System and Marker Beacon test page.

Selects the VHF Omnidirectional Ranging (VOR) test page.

COM Menu

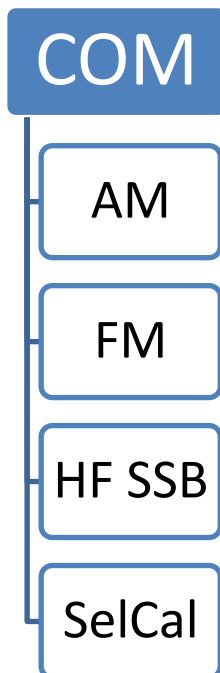

Selects the Com Amplitude Modulation (AM) capability test page.

Selects the Com Frequency Modulation (FM) capability test page.

Selects the COM High Frequency SSB capability test page.

Selects the SELCAL capability test page.

ELT Menu



Selects the Emergency Location Transmitter capability test page. 121.5 MHz, 243 MHz, and 406 MHz

DME Menu

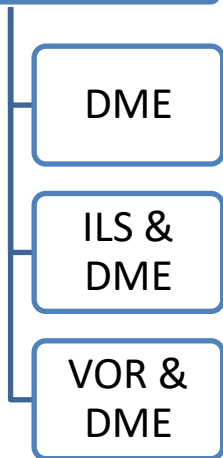

Selects the Distance Measuring capability test page.

Selects the DME and combined ILS capability test page. This gives a dual capability of DME and ILS pseudo beacons at the same time.

Selects the DME and combined VOR capability test page. This gives a dual capability of DME and VOR pseudo beacons at the same time.

ATC Menu (Transponder)

ATC	
Mode S	Selects the Mode S Test Functions – See Mode S Menu
ADS-B	Selects the ADS-B Test Functions – See ADS-B Menu
ATCRBS	Selects the ATCRBS Test Functions – See ATCRBS Menu
UAT	Selects the UAT (978 MHz) Test Functions – See UAT Menu
TIS-B	Selects the TIS-B (1090 MHz) capability test page.
Identity Check	Selects the Identity Check capability test tool to quickly detect Mode-S or ATCRBS aircraft identity.

ADS-B	
ADS-B OUT	Selects the Mode ADS-B Out Test Functions – ADS-B Out generated from the aircraft under test.
ADS-B IN	Selects the Mode ADS-B In Test Functions – ADSB- IN generated from the ARTS 7000 to the aircraft under test.

Mode S Menu

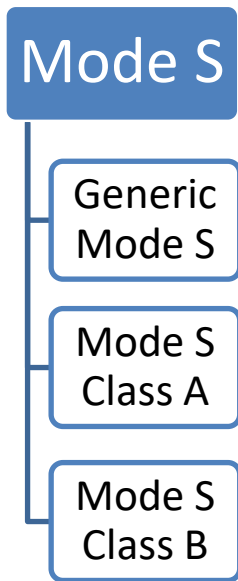

Selects the Mode S Generic Test Page.

Selects the Mode S test for a class A Transponder.

Selects the Basic Mode S test for a class B Transponder.

ATCRBS Menu

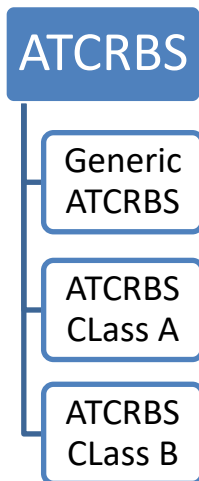

Selects the Generic ATCRBS test page. This is a generic ATCRBS test that meets Far 43 Appendix F

Selects the Generic ATCRBS class A Transponder test page. This is an ATCRBS class A transponder test that meets Far 43 Appendix F

Selects the Generic ATCRBS class B Transponder test page. This is an ATCRBS class B transponder test that meets Far 43 Appendix F

UAT Menu

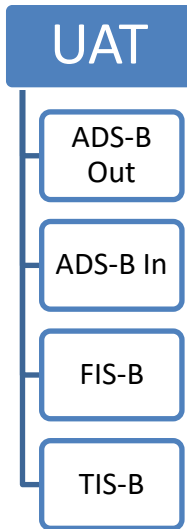

Selects the UAT ADS-B Out (978 MHz) capability test page.

Selects the UAT ADS-B In (978 MHz) capability test page.

Selects the UAT FIS-B (978 MHz) capability test page.

Selects the UAT TIS-B (978 MHz) capability test page.

TCAS Menu

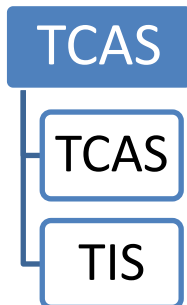

Selects the TCAS capability test page. TCAS1, TCAS 2, ACAS

Selects the TIS (1090 MHz) capability test page.

Altitude Monitoring Menu



Selects the Altitude Monitoring page to control Laversab ADTS while receiving simultaneous Transponder information

GPS Menu

GPS

Selects the GPS Simulator test page.

RF Tools

RF Tools

Counter &
Meter

Selects the TCAS capability test page. TCAS1, TCAS 2, ACAS

Frequency
Scanner

Selects the TIS (1090 MHz) capability test page.

VSWR /
LOSS

Selects the VSWR & Gain/Loss Analyzer test page.

Distance
to Fault

Select the Distance to Fault test page.

SECTION 3: ARTS 7000 TEST CONTROL APPLICATION

SUBSECTION 1: TEST CONTROL APPLICATION – NORMAL OR DEMO/TRAINING MODE

The ARTS 7000 Test Control Application can be operated in 2 Modes:

1. Normal operation mode: connected to an ARTS 7000 Test Set and used for testing Aircraft Systems. See below for system setup.
2. Demo/Offline Mode: In this mode there is no requirement for a connection to an ARTS 7000 Test Set. The application can be open and run in a pseudo-operational mode allowing the user to demonstrate/learn or complete training exercises at their convenience remotely from an aircraft. All test functions are available, and the Application will run as normal. Note there will be no test results or indications.

To Enter into Demo/Offline Mode:

Note in Demo/Offline Mode the Tablet Controller does not need to be connected to any Wi-Fi/Internet service.

1. From the Home screen of the Tablet Controller navigate to the ARTS 7000 Application.
2. Open the application.
3. When the Communication Interface Test Screen appears press the **Offline** button.
4. The application will now open in Demo mode.

SUBSECTION 2: POWER UP, WI-FI CONNECTION AND APPLICATION START

1. Set up the ARTS 7000 test system on level ground or bench top making sure there are no hazards that may damage the test system or harm the operator.
2. Apply power to the ARTS 7000.
3. If using the battery to power the test system switch the DC power selector to Battery.
4. If using an External 28VDC power source to power the test system switch the DC power selector to 28VDC.
5. If using mains power to power the test system, connect the power cable to the ARTS 7000 power connector and to a suitable power source. Switch the Power Selector Switch to the mains position.
6. Switch ON the main power switch. The ARTS 7000 Test set will now power up and establish its own Wi-Fi network. This may take a few minutes.

7. Power up the Test Control Tablet. The following process may differ depending on the software version on the tablet.
8. Once the tablet is running navigate to the settings menu. Select Wi-Fi.
9. Search for the ARTS 7000 Wi-Fi Network. The ARTS 7000 network is identified as ARTS-XXXXX where XXXXX is the serial number of the ARTS 7000
10. Select the ARTS 7000 Wi-Fi and establish a connection.
11. Once ARTS 7000 Wi-Fi Network is connected and stable navigate to the home page of the tablet.
12. On the tablet select the ARTS 7000 application and open the application.
13. The Tablet controller application will now show the following screen.

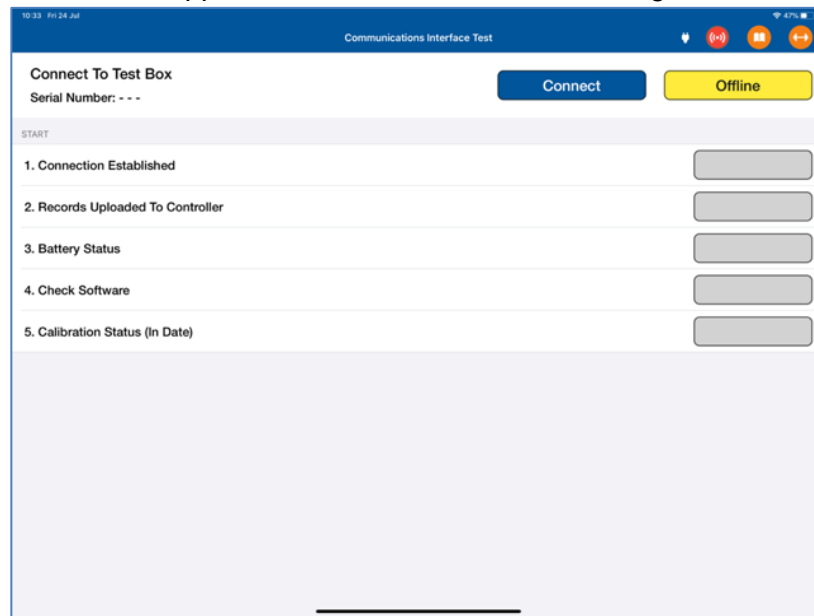



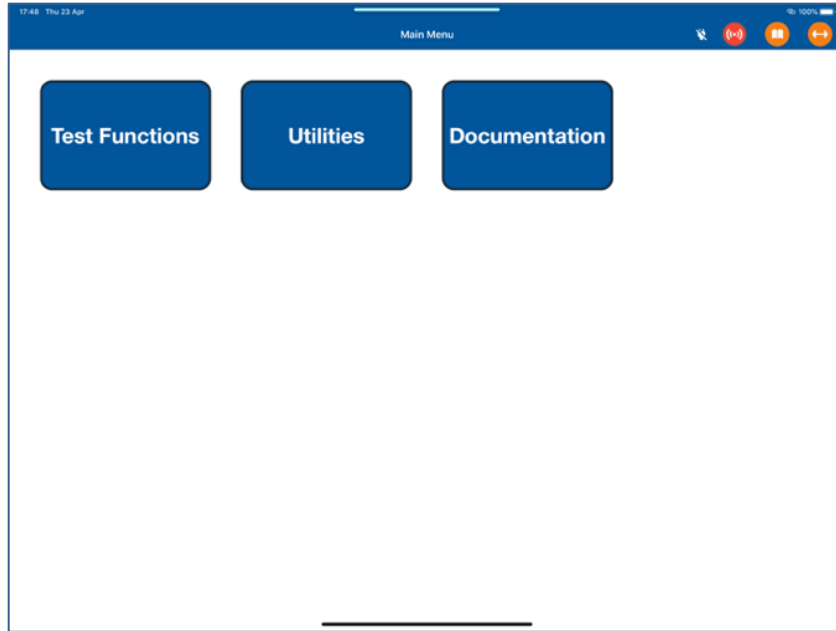





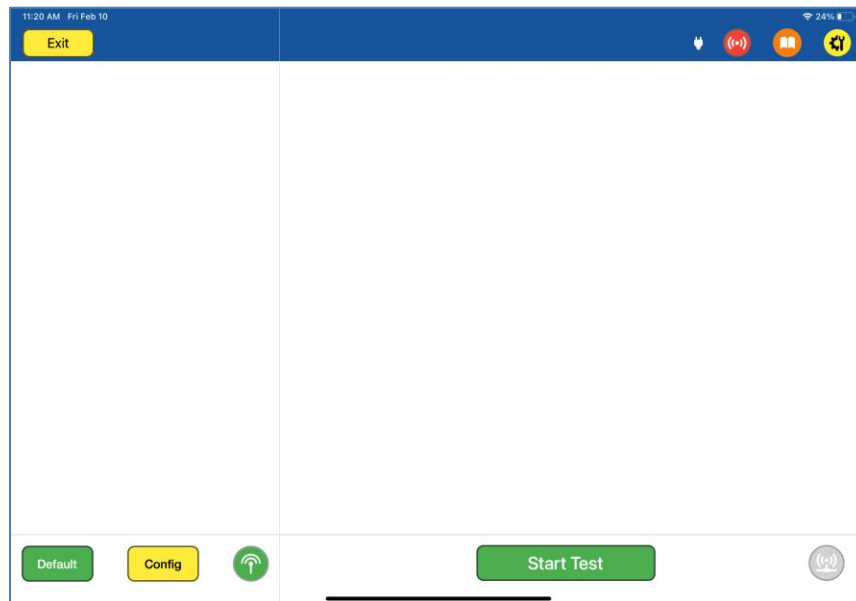

14. Select **Connect**.
15. The ARTS 7000 will run through some basic confidence checks and establish a connection to the ARTS 7000 Test Box.
16. Once the Quick check is Complete the Controller tablet will show the main menu. The Test Set is now ready for use.





SUBSECTION 3: GENERIC CONTROLS AND INDICATORS

There are some key features to the application that are available on all test screens. These are defined below:



Item	Description
	Exit Button takes the user back to the previous menu page.
	Returns to the previous page. (Not shown above)
	Power Indicator identifies that the test set is connected to Mains power or running on Batteries.
	Indicator showing the Wi-Fi connection quality from tablet to test set. Green connection is strong; Red connection is poor.
	Quick link to the In-App relevant pages in User Manual or corresponding Training Video (requires internet access).
	Support button to capture and issue and create a support request.
	Indicator for active RF transmission. Only active during a test. Green indicates that active RF signals are being transmitted from the ARTS.
	Default button resets all settings relevant to the current test to their default configuration.
	Config button is only available from an active test page and allows the user to view and configure relevant test parameters.

  	<p>Indicator to show the type of connection from ARTS to UUT Antenna. Depending on the test, options may include: Antenna (top), Direct Cable (middle), and Coupler (bottom).</p>
---	---

SECTION 4: ARTS 7000 TEST CONTROL APPLICATION MENUS

Main Menu

On the application Main Menu there are 3 options: Test Functions, Utilities and Documentation. Test Functions contain the individual test capabilities of the ARTS 7000. These items are described in this manual in the individual sections relevant to the capability. The Utilities and Documentation sub-menus are described below:

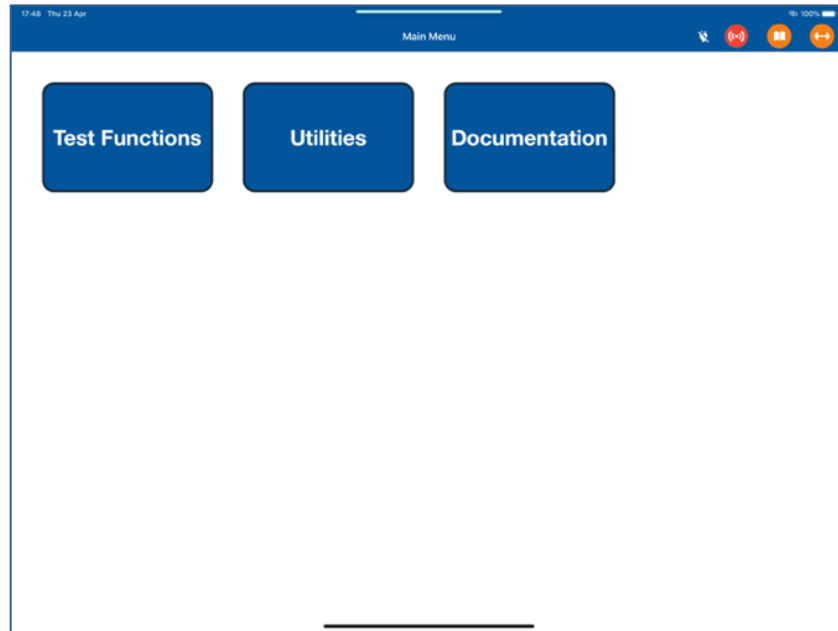

SUBSECTION 1: THE UTILITIES MENU

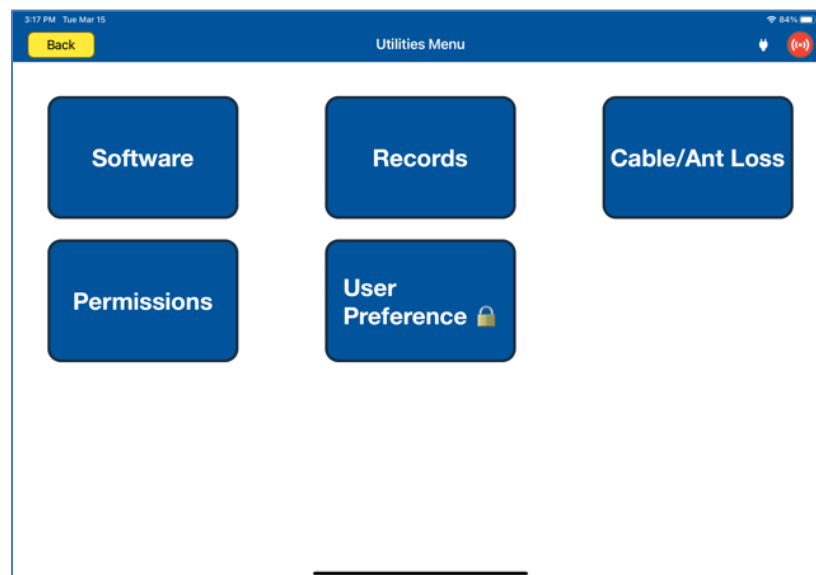

Software

Selecting the Software button displays the software revisions page. When the Test Control Tablet is not connected to the ARTS, this page will only display the Test Control Tablet application version. If the Test Control Tablet is connected to the ARTS, the full software and firmware versions of the Application and the test set are shown.

Below are examples of both scenarios.

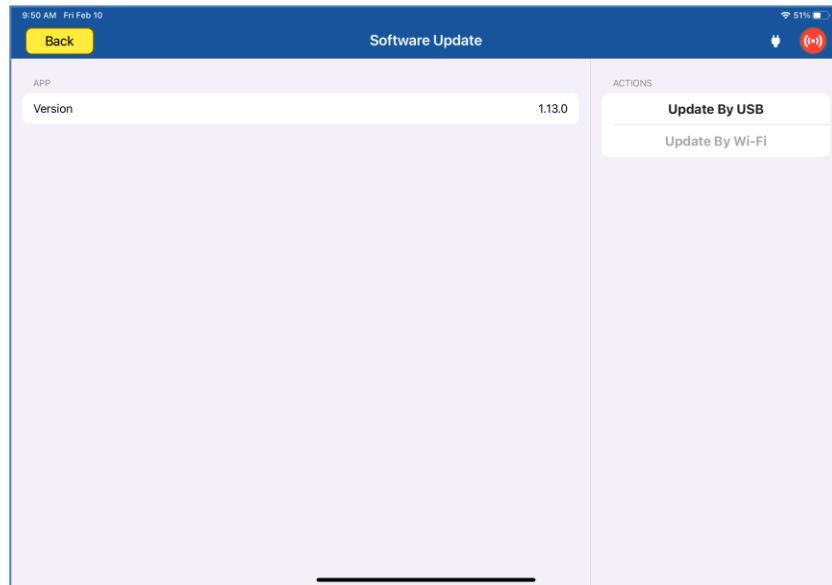

No ARTS 7000 connected.

With ARTS 7000 connected, the software page displays all installed software including the application and the firmware installed on the Nav/Com and Pulse Modules.

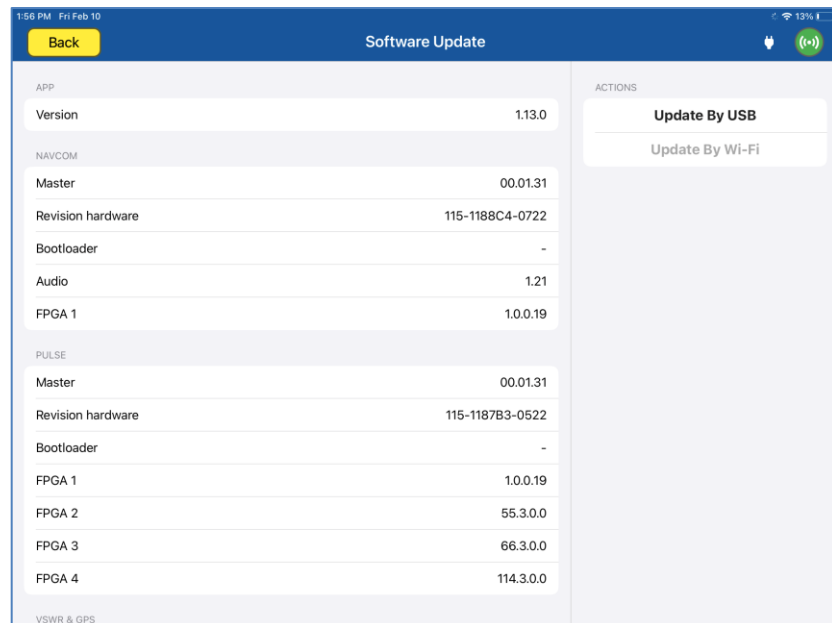

ARTS 7000 connected.

To update the software installed on the ARTS 7000 please refer to the section on **Software Updates**.

Records Menu and Records Export

Whenever the ARTS 7000 completes a test, and the capability has results that can be stored, they are accessible on this page. The records are sorted by capability and then time.

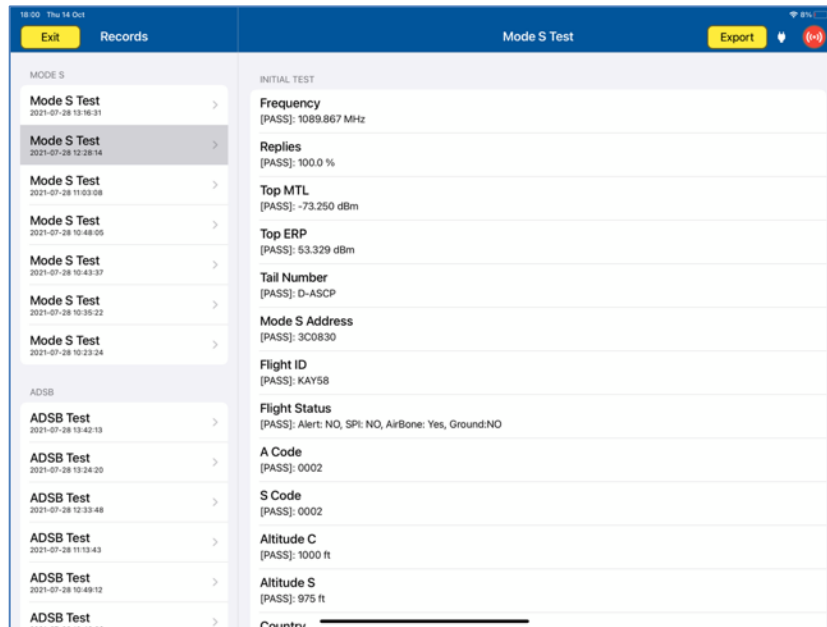

Each result can be selected, viewed, and exported.

To export a record:

1. Connect the Test Control Tablet to a suitable Wi-Fi.
2. Select the result to be exported.
3. Once the result information is displayed, the file can be exported by pressing the **Export** button.
4. The application will present an export menu. This allows the file to be copied or sent via any installed application or service, including SMS or Email.

Cable/Ant Loss

For the ARTS 7000 to make accurate measurements, the losses of the cables and antenna that are used in the test must be considered. The Cable/Ant Loss page is the central point to store this information. This information must be updated after system calibration or when new cables or antennae are used. It is not necessary to update the values regularly. Once entered, they are stored for use in the application.

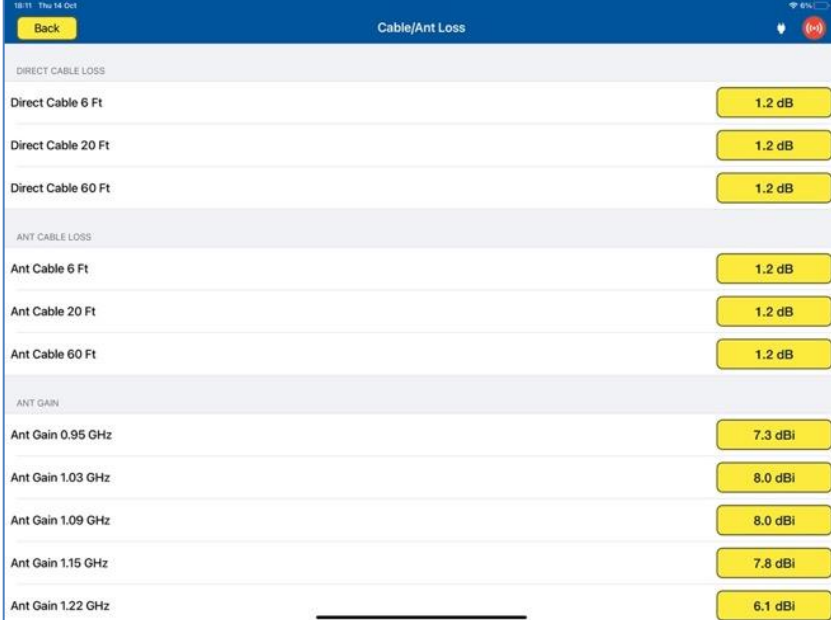

Section	Item	Value
DIRECT CABLE LOSS	Direct Cable 6 Ft	1.2 dB
	Direct Cable 20 Ft	1.2 dB
	Direct Cable 60 Ft	1.2 dB
ANT CABLE LOSS	Ant Cable 6 Ft	1.2 dB
	Ant Cable 20 Ft	1.2 dB
	Ant Cable 60 Ft	1.2 dB
ANT GAIN	Ant Gain 0.95 GHz	7.3 dBi
	Ant Gain 1.03 GHz	8.0 dBi
	Ant Gain 1.09 GHz	8.0 dBi
	Ant Gain 1.15 GHz	7.8 dBi
	Ant Gain 1.22 GHz	6.1 dBi

Cable/Ant Loss configuration

This page is split into three areas: Direct Cable Loss, Antenna Cable Loss, and Antenna Gain.

In most cases the Direct Cable and Antenna cable losses are the same, as the same cables are normally used in both tests. The measured Antenna Gains are located on a sticker on the back of the ARTS antenna. These values were measured during the production of the antenna and are unlikely to change – unless the antenna is later calibrated. If this occurs, the new values found on the antenna sticker or in the calibration paperwork must be updated into the relevant fields.

Permissions

The Permissions page allows operators to view, add, and remove licenses related to the ARTS 7000 they may have purchased. Each license is tied to the Serial Number of the ARTS 7000 unit. Users can contact Laversab to add licenses as desired.

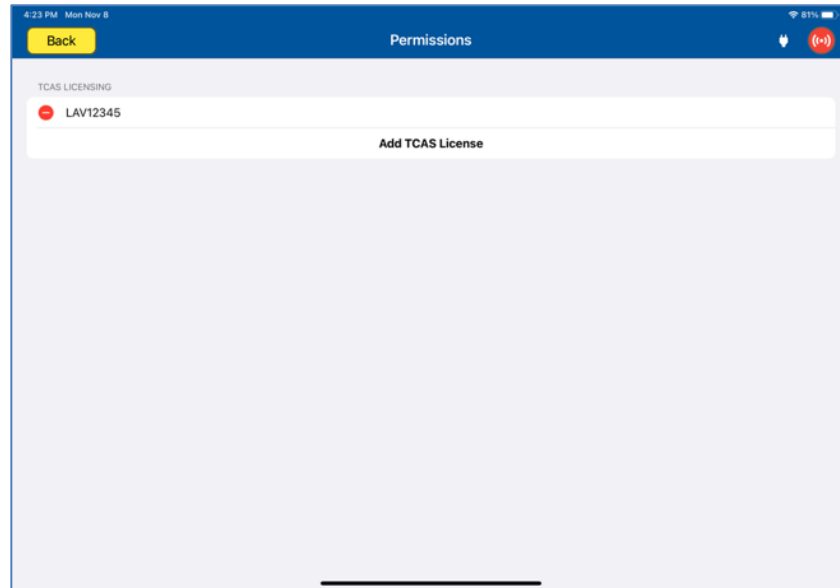

Permissions Screen

User Preferences

The user preference page allows operators to customize certain features of the ARTS 7000 Applications. It is also used for trouble shooting any issues. The functions in this menu are password protected – the default password is: 123456.

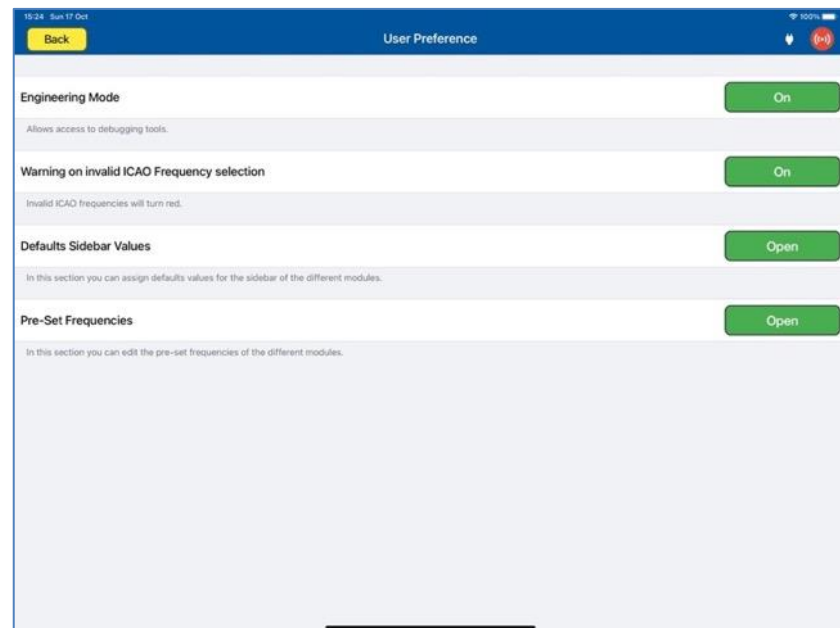

User Preferences Screen

Engineering Mode: Enables Engineering mode for troubleshooting the ARTS 7000 test system. When Engineering Mode is 'On', the Engineering Mode menu can be accessed in **Utilities > Engineering Mode**.

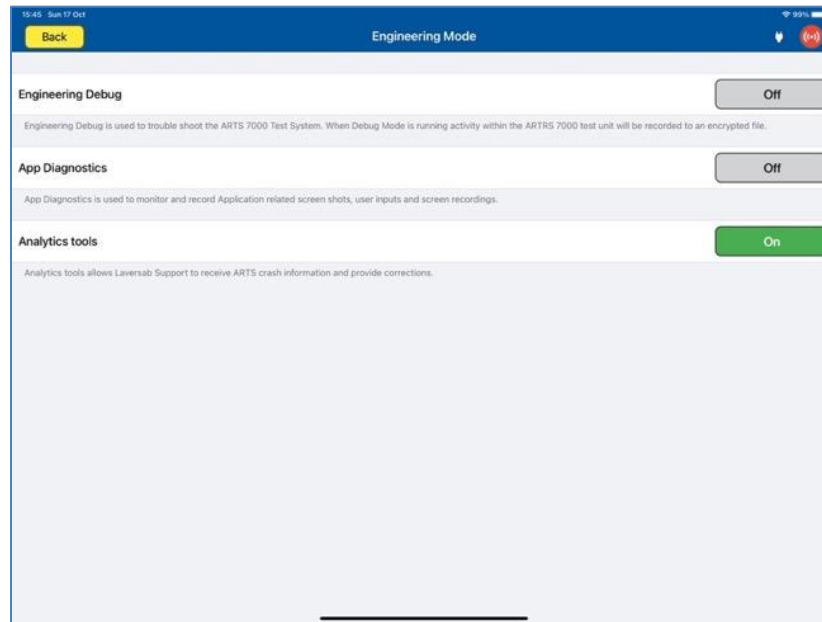

Engineering Mode Screen

User Selections for Engineering Mode:

- **Engineering Debug:** When enabled the ARTS will 7000 will record all activity of the test set and save it to an encrypted file that can be sent to Laversab for review.
- **App Diagnostics:** When enabled the system will monitor and record all activity in the application, which can be used for review.
- **Analytics tools:** In the event of a system crash the nature of the crash can be reviewed by Laversab.

Warning on Invalid ICAO Frequencies: When 'On' the ARTS 7000 application will warn the operator if an invalid frequency is selected. Any frequency selection that is not compatible to a valid ICAO frequency will be displayed in **RED** font. This function is intended to simplify selection and reduce operator error.

Default Sidebar Values: This parameter allows the use to set the initial parameters of each test capability. This feature is intended to simplify and speed up the initial test set up. The 'Restore Settings' button at the top of the page will set all parameters to the factory default.

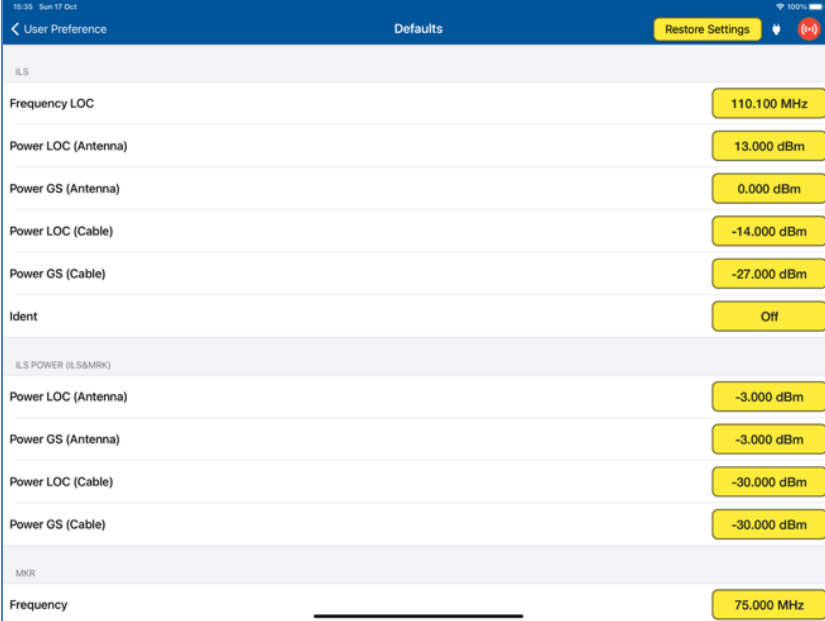

The screenshot displays the 'Defaults' screen in the ARTS 7000 application. The screen is titled 'User Preference Defaults' and features a 'Restore Settings' button in the top right corner. The parameters are organized into sections: ILS, ILS POWER (ILS&MRK), and MKR. Each parameter has a corresponding value displayed in a yellow button.

Section	Parameter	Value
ILS	Frequency LOC	110.100 MHz
	Power LOC (Antenna)	13.000 dBm
	Power GS (Antenna)	0.000 dBm
	Power LOC (Cable)	-14.000 dBm
	Power GS (Cable)	-27.000 dBm
	Ident	Off
ILS POWER (ILS&MRK)	Power LOC (Antenna)	-3.000 dBm
	Power GS (Antenna)	-3.000 dBm
	Power LOC (Cable)	-30.000 dBm
	Power GS (Cable)	-30.000 dBm
MKR	Frequency	75.000 MHz

Default Sidebar Values Screen

SUBSECTION 2: DOCUMENTATION MENU

Selecting the Documentation Button from the Main menu brings up the Documentation Menu.

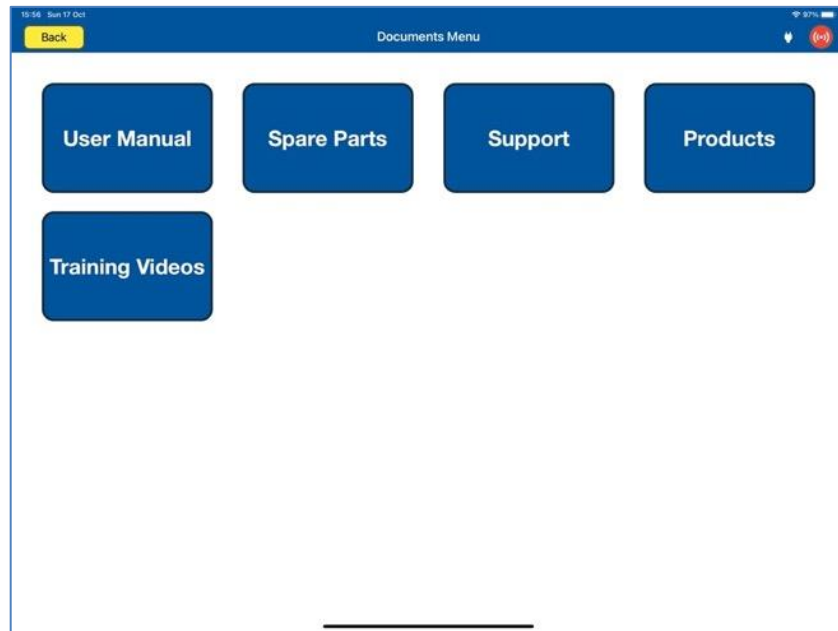

Documentation Menu Screen

Documentation Menu Selections

User Manual: Displays the latest version of the user manual of the ARTS 7000.

Spare Parts: Displays a list of key Spare parts & Accessories that are used with the ARTS 7000. Part numbers are included so ordering spares from Laversab is simplified.

Support: Generates Support Request information – Please note that for this function, the Test Control Tablet needs to be connected to an internet capable Wi-Fi source.

Products: Lists the current Laversab products – Please note for this function, the Test Control Tablet needs to be connected to an internet capable Wi-Fi source.

Training Video: Links to the Laversab training videos. Test selections are split into each individual capability. Please note that for this function, the Test Control Tablet needs to be connected to an internet capable Wi-Fi network.

SECTION 5: ARTS 7000 SOFTWARE UPDATES

SUBSECTION 1: TEST CONTROLLER APPLICATION SOFTWARE UPDATE

1. Switch ON the iPad Test Controller Tablet.
2. Navigate to **Settings** > **Wi-Fi** and connect Wi-Fi network with internet connection.
3. Note – Do NOT connect to the ARTS 7000 Test System.
4. Download & install the ARTS 7000 application:
 - i. From the iPad App Store, search for 'Laversab ARTS 7000'
 - ii. Download & install the ARTS 7000 application.
5. Once the process is complete launch the ARTS 7000 Control Application and navigate to the **Utilities** > **Software** section to verify the latest version of the Controller Application Software has been installed.

SUBSECTION 2: ARTS 7000 FIRMWARE UPDATE BY WI-FI

WARNING

When updating the software in the ARTS 7000 it is imperative to use an AC power source during the following procedure.

Items required:

- ARTS 7000 Test System
- AC Power cable for ARTS 7000
- ARTS 7000 iPad controller

ARTS 7000 Update Procedure

1. **Power ON the ARTS 7000 (if necessary)**
Connect the ARTS 7000 to an AC power outlet. Select AC power on the top panel of the ARTS 7000 and switch ON the ARTS 7000.
2. **Power ON and set up the iPad Controller (if necessary).**
It is recommended to close all open applications on the iPad.

On the iPad main menu:

- a. Select **Settings**.
- b. Open the **Wi-Fi**.

- c. Select the network **ARTS-XXXXX** (where XXXXX is the serial number of the ARTS 7000 test set). Note: the ARTS-XXXXX WiFi may take a few minutes before it is available.
- d. If a Password is required, please use - **laversab**
- e. Return to the main page of the iPad.

3. Run the ARTS 7000 Application

- a. Open the ARTS 7000 Application.
- b. Press **Connect**.
- c. The connection status is shown identifying the serial number of the ARTS 7000 and the modules installed.
- d. Press **Confirm** and then **Next**. The main menu of the ARTS 7000 application is now shown.
- e. Enter the **Utilities** menu and press **Software**.

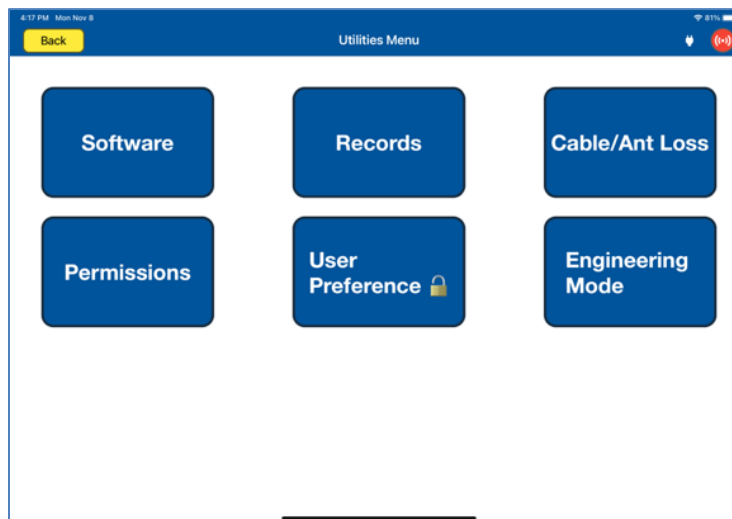
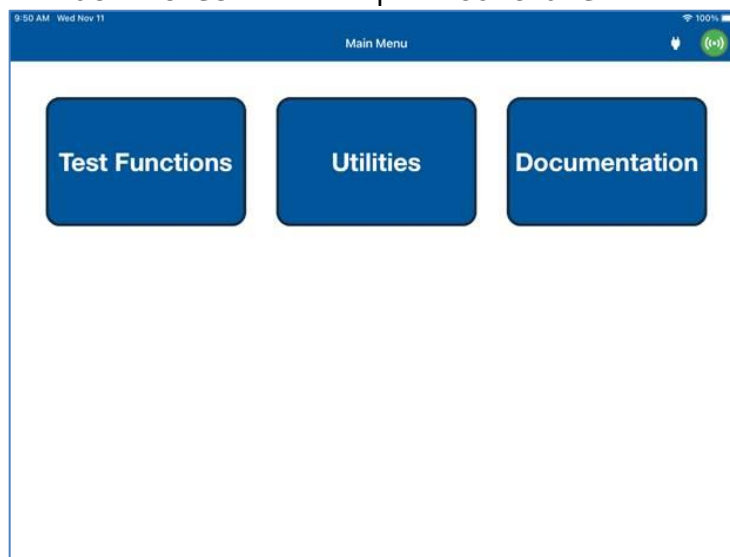

- f. The tablet controller now displays the **ARTS Versions** screen and displays the current software build of the ARTS 7000. This may take a few moments. (It is recommended to take a screen shot of this page to keep a record of the current software build state. The process for taking screen shots on different tablet controllers varies. Please refer to your specific model).

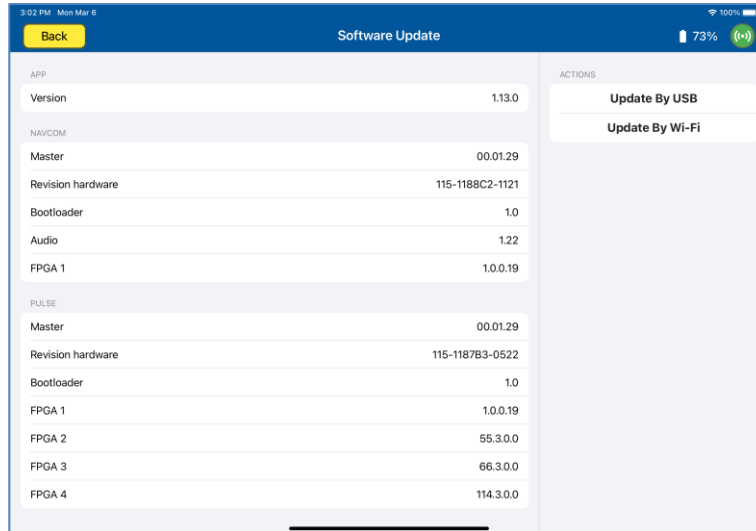

4. Update procedure

IMPORTANT: We highly recommend that the unit is connected to AC power and battery, it must be ON throughout the entire process. A failure while updating can cause a programming corruption that could damage the unit.

- a. Press **Update By Wi-Fi**. The iPad will now show the following screen:

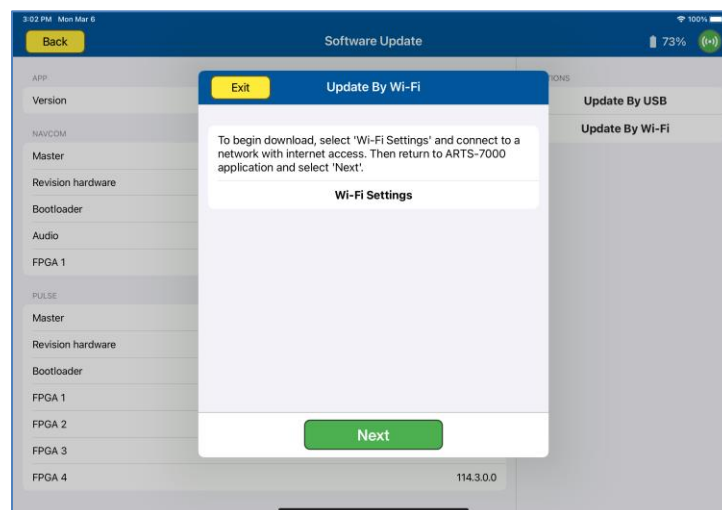

- b. Ensure the iPad is connected to a network with internet access, return to the ARTS-7000 application, and press **Next** to download the firmware.
- c. After the download is completed, reconnect to the ARTS-7000 Wi-Fi, and press **Next**.

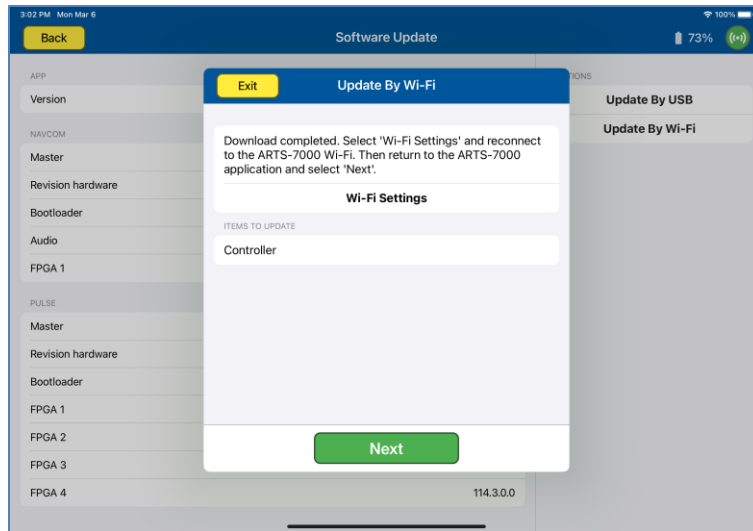

- d. The following screen will show when the firmware on the ARTS-7000 is being updated:

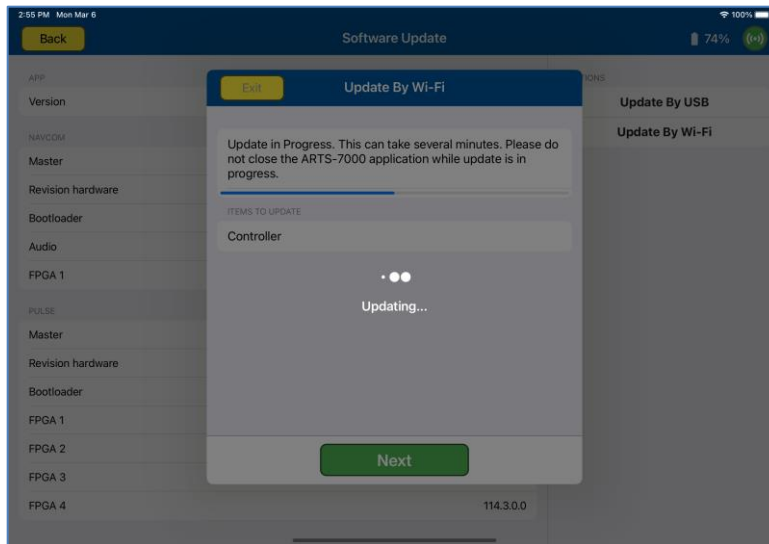

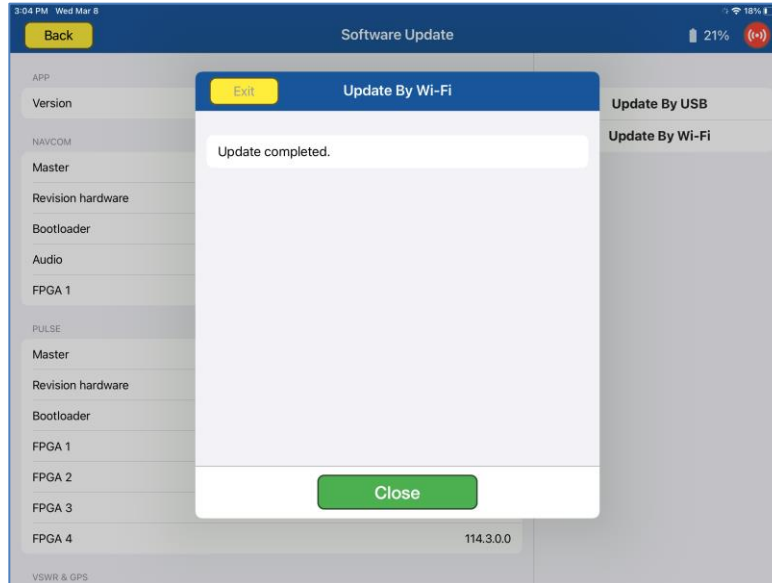

SUBSECTION 3: ARTS 7000 FIRMWARE UPDATE BY USB

Items required:

WARNING

When updating the software in the ARTS 7000 it is imperative to use an AC power source during the following procedure.

- ARTS 7000 Test System
- AC Power cable for ARTS 7000
- ARTS 7000 iPad controller
- USB memory stick - minimum 16GB (cleanly formatted to FAT32 file system)

ARTS 7000 Update Procedure

1. Software update preparation

- a. Download the update files from the Laversab website or from the email sent to you from Laversab.
- b. Verify the correct number of files in the package. Typically there is only one, and it has an extension of '.fw'
 - i. **artsX.fw**
- c. Format a USB memory stick using the FAT32 file system.
- d. Create a New Folder on the USB memory stick. Using only lowercase letters, name the folder: **update**

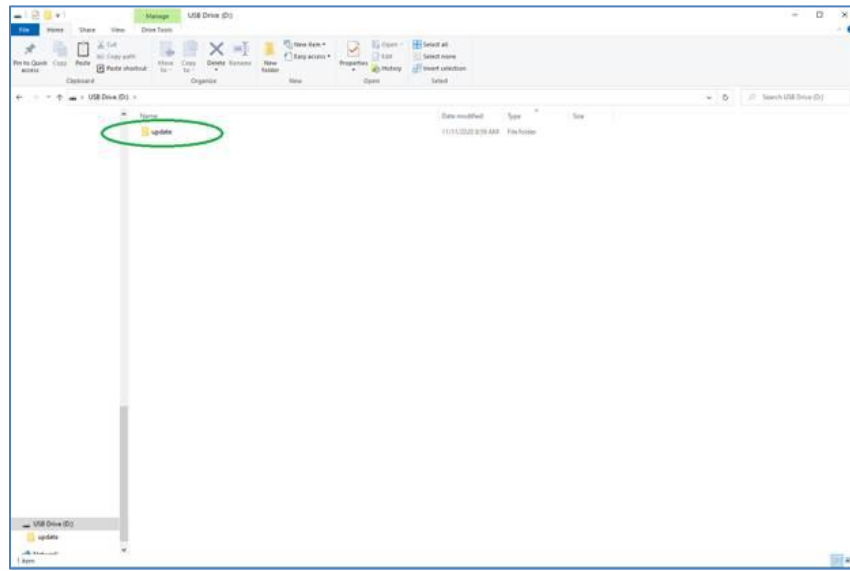

- e. Copy the file(s) (from 1.b.) into the update folder.
- f. Safely remove the USB drive from your computer.

Note: Please review the online video [here](#) to see an example of preparing the USB memory stick.

2. Power ON the ARTS 7000 (if necessary)

Connect the ARTS 7000 to an AC power outlet. Select AC power on the top panel of the ARTS 7000 and switch ON the ARTS 7000.

3. Power ON and set up the iPad Controller (if necessary).

It is recommended to close all open applications on the iPad.

On the iPad main menu:

- a. Select **Settings**.
- b. Open the **Wi-Fi**.
- c. Select the network **ARTS-XXXXX** (where XXXXX is the serial number of the ARTS 7000 test set). Note: the ARTS-XXXXX WiFi may take a few minutes before it is available.
- d. If a Password is required, please use - **laversab**
- e. Return to the main page of the iPad.

4. Run the ARTS 7000 Application

- a. Open the ARTS 7000 Application.
- b. Press **Connect**.
- c. The connection status is shown identifying the serial number of the ARTS 7000 and the modules installed.
- d. Press **Confirm** and then **Next**. The main menu of the ARTS 7000 application is now shown.
- e. Enter the **Utilities** menu and press **Software**.

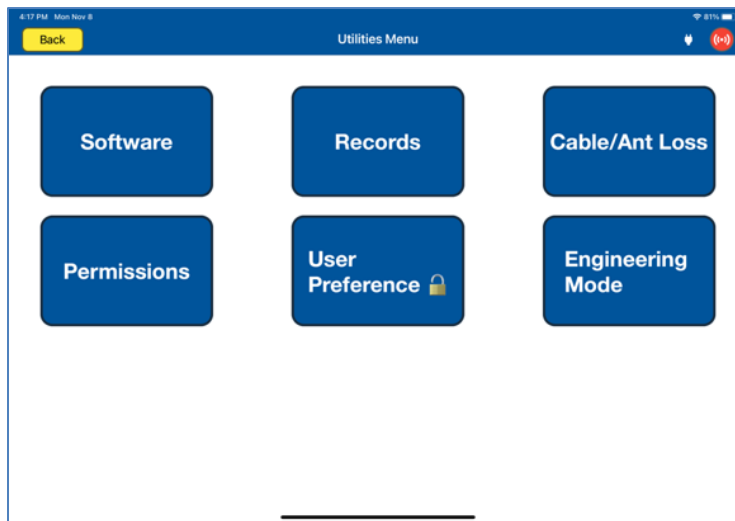
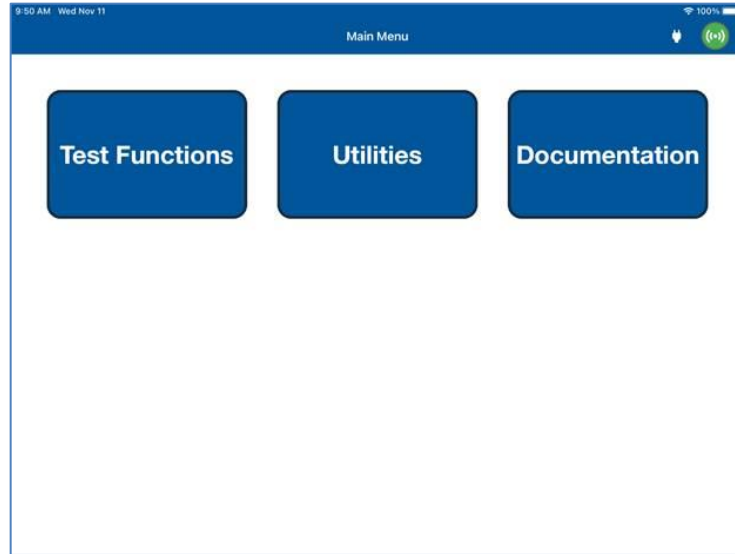

- f. The tablet controller now displays the **ARTS Versions** screen and displays the current software build of the ARTS 7000. This may take a few moments. (It is recommended to take a screen shot of this page to keep a record of the current software build state. The process for taking screen shots on different tablet controllers varies. Please refer to your specific model).



5. Update procedure

IMPORTANT: We highly recommend that the unit is connected to AC power and battery, it must be ON throughout the entire process. A failure while updating can cause a programming corruption that could damage the unit. The USB must be connected during the process and must not be removed at any time until the update is complete.

- a. Plug the USB memory stick prepared earlier into the USB slot on the top left of the Nav Com Module. Then press **Update By USB** in the tablet application.



- b. The iPad will now show the following screen:

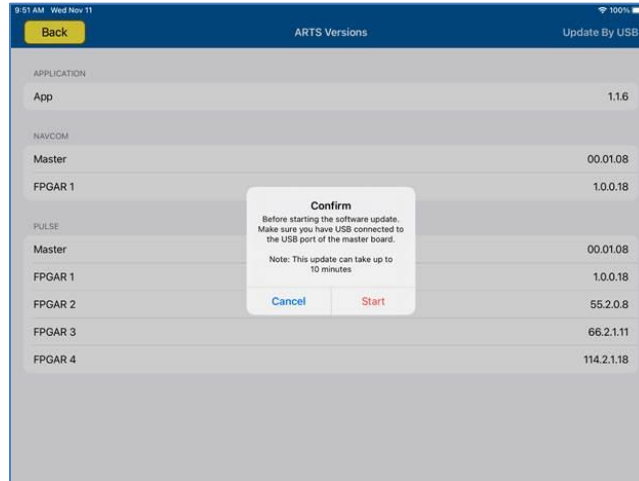

- c. Press **start** to begin the Software upload. Please note: this process can take up to 10 minutes.
- d. During the upload the iPad screen will show the following updating screen and progress screen:

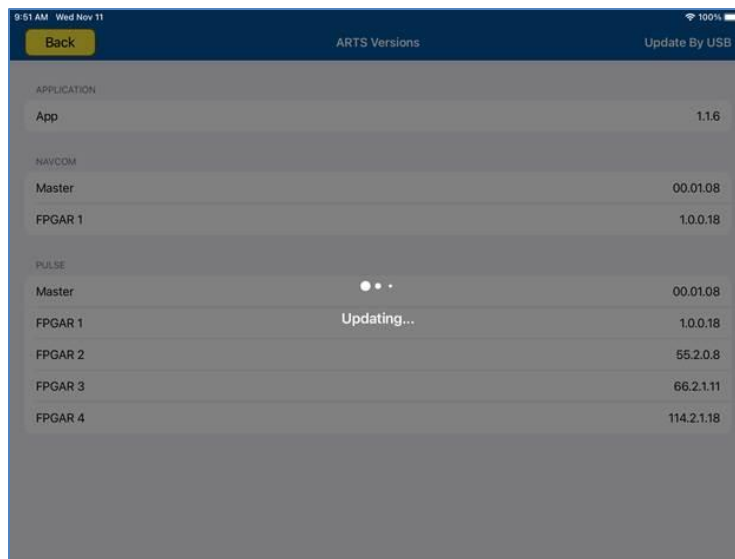

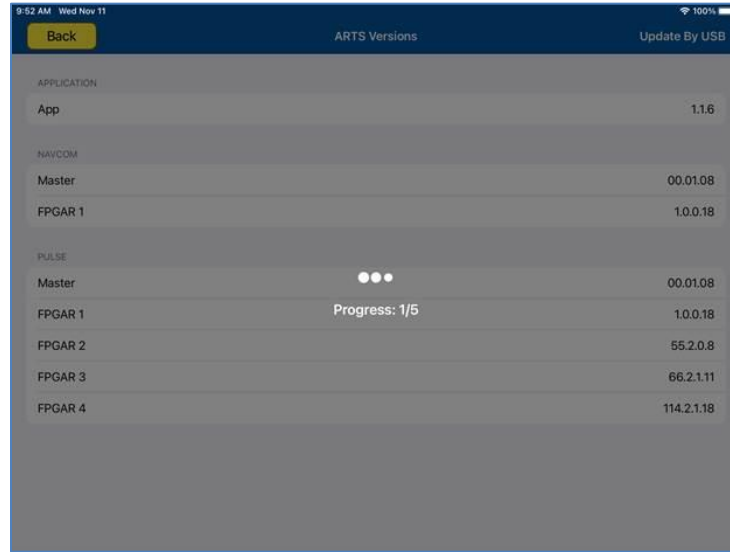

- e. When the upload is complete the iPad will show the updated software on the following screen. Note: the picture is for illustration only, the versions will be different to those shown.



- f. It is recommended to take another screen shot of the ARTS versions page to confirm the update and keep a record of the software installed.

6. Shut down procedure

- To finalize the update press **Back** to return to the Utilities menu and **Back** to return to the Main menu.
- Close the iPad ARTS 7000 application.
- Power down the ARTS 7000.
- Remove the USB drive from the USB slot on the Nav/Com Module.

The ARTS 7000 system can now be used as normal.

SECTION 6: ARTS 7000 TEST SET HARDWARE CONTROLS & CONNECTIONS

SUBSECTION 1: ARTS 7000 TEST SET HARDWARE, CONTROLS & CONNECTIONS

Test Set General



ARTS 7000 Test Set General View



ARTS 7000 Test Set in Use

The ARTS 7000 is housed in a high-quality ruggedized roller case.

Please note: the case is ruggedized for operational use. When the ARTS is being shipped it requires a dedicated shipping case or high-quality packaging.

Dimensions	Weight
22" x 14" x 9"	30 lbs
56cm x 36cm x 23cm	14 kg



ARTS 7000 lid latch in unused position



ARTS 7000 lid latch in operational position

ARTS 7000 Test Set Top Panel



Item	Description
1	Battery – Removable battery
2	Power Switches and Connections – Power control
3	Nav/Com Module – Used for all Navigation and Communication functions.
4	Pulse Module – Used for all Pulse (Transponder/DME/TCAS) functions
5	GPS & VSWR Module – Used for GPS Simulator & VSWR functions.
6	Expansion Slot – Expansion Slots for future capability development
7	Ground Connector
8	Lid Latch – holds the test set lid in the open position during operation

Power Switches and Connections

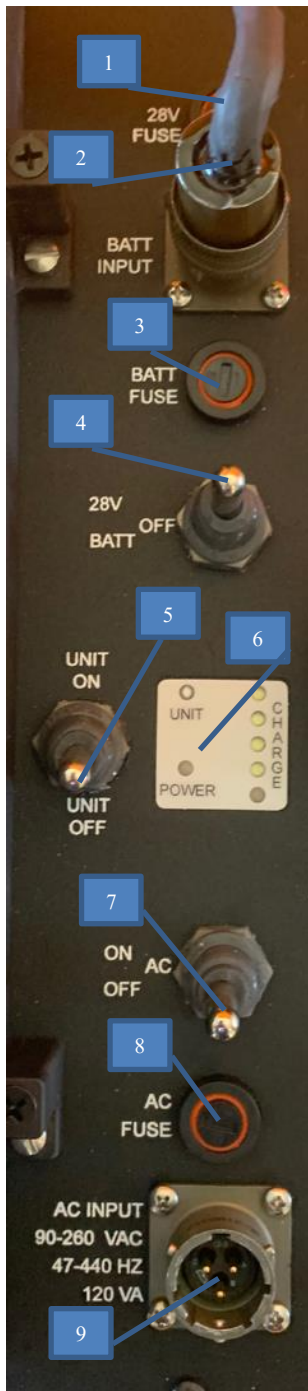

Item	Description
1	28V Fuse
2	DC Power connector for battery or external 28VDC power
3	Battery Fuse
4	DC Power Selector used to select DC power source. Selections: 28VDC (External) - Off - Battery
5	Unit Power Switch – Main Power switch for setting the unit On - Off
6	Power LED Indicator Panel <ul style="list-style-type: none"> <i>Unit</i>: Lit when the ARTS 7000 is on and active. <i>Power</i>: Lit when the ARTS 7000 is has a suitable power source available <i>Charge LEDs</i>: Indicate the charge state of the battery
7	AC Power Switch ON - Off
8	AC Power Fuse
9	AC Power connector – Aircraft AC or mains outlet power connector - Suitable for any 90-260VAC 47-400Hz 120VA AC source

Nav/Com Module



Item	Description
1	USB Connector: Used for updating the software within the ARTS 7000 Test Set.
2	Antenna connection (1W Maximum): Used for connecting the ARTS 7000 Test Antenna for over the air testing.
3	Cable Connection (100W Maximum): Used for Direct /Cable connection between the ARTS 7000 Test Set and a radio or antenna feeder.
4	Wi-Fi Antenna
5	GPS Antenna
6	COM LED Indicator: Lit during an active COM test.
7	LOC LED Indicator: Lit during an active LOC test.
8	GS LED Indicator: Lit during an active GS test.
9	OM LED Indicator: Lit when an Outer Mkr is active.
10	MM LED Indicator: Lit when a Middle Mkr is active.
11	IM LED Indicator: Lit when an Inner Mkr is active.
12	VOR LED Indicator: Lit during an active VOR test.
13	ADTS Connector: Used for a direct connection to a Laversab Air Data Testing. This connection allows both the ARTS 7000 and an ADTS to be controlled by a single Tablet controller for Altitude/Transponder encoder testing.

Pulse Module



Item	Description
1	Antenna connection (1W Maximum): Used for connecting the Test Antenna for over-the-air testing.
2	Cable Connection (100W Maximum): Used for Direct /Cable connecting the test set directly to a radio or to antenna feeder.
3	DME LED Indicator: Lit during an active DME test.
4	XPNDR LED Indicator: Lit during an active Transponder test.
5	TCAS LED Indicator: Lit during an active TCAS test. (TCAS functionality is optional)
6	TIS LED Indicator: Lit during an active TIS test.
7	INTR LED Indicator: Lit whenever the ARTS 7000 is sending an interrogation to the Radio/Aircraft under test. (Normally flashing during the Interrogation)
8	RPLY LED Indicator: Lit whenever the ARTS 7000 is Receiving a reply from the Radio/Aircraft under test. (Normally flashing during the Reply)

GPS Simulator & VSWR Module

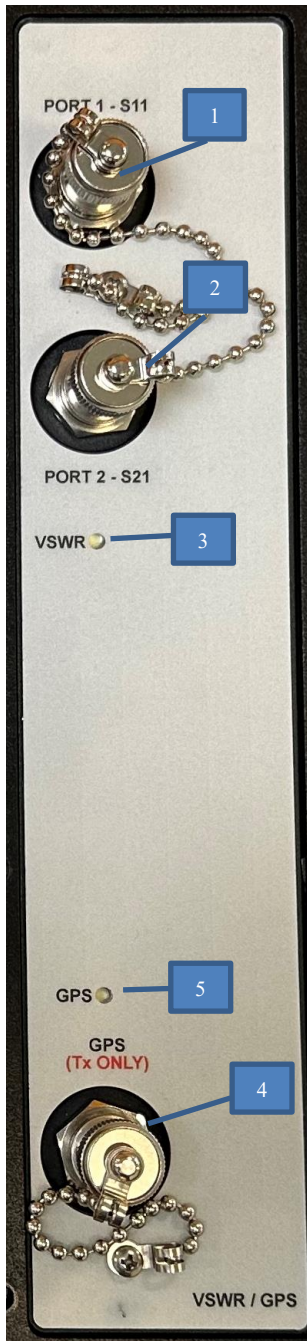

Item	Description
1	VSWR Port 1 – S11 Cable Connection
2	VSWR Port 2 – S21 Cable Connection
3	VSWR Indicator: Lit during an active VSWR test.
4	GPS Simulator: Transmit port; Cable to GPS coupler only.
5	GPS LED Indicator: Lit during an active GPS signal transmission.

Expansion Slots

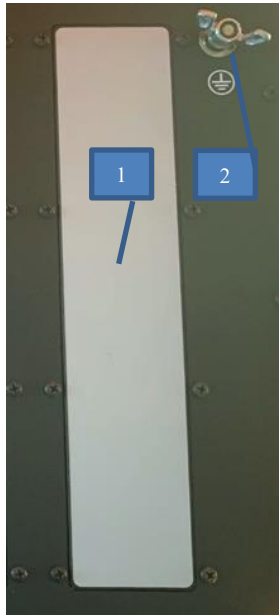

Item	Description
1	Expansion Slot: Used for future capability expansion.
2	Ground Connection point.

General accessories



1. Accessory Storage case



2. Antenna Mounting Tripod



3. Battery

Item	Description	Part Number
1	Accessory Storage case used to hold and transport antenna cables etc.	118-1945
2	Antenna Mounting Tripod. Used to mount the Pulse antenna but can also be used to mount the Nav/Com antenna remotely from the ARTS 7000 Test Set using the supplied Mounting adapter.	118-2286
3	Removable Battery	115-1282
Not Shown	External Battery Charger	115-1304

Nav Com Antenna



1. NAV/COM Telescopic Antenna in operation on an ARTS 7000 Test Set



2. Telescopic Antenna



3. NAV/Com Telescopic Antenna tripod mounting adapter

Item	Description	Part Number
1 & 2	Telescopic Antenna for all Nav Com Functions.	123-0239
3	NAV/Com Telescopic Antenna tripod mounting adapter. This adapter is used to allow the Nav Com antenna to be mounted onto the tripod for remote operation from the ARTS 7000.	116-0349

Pulse Antenna



1. Pulse Antenna mounted on tripod.



2. Pulse antenna in use.

Item	Description	Part Number
1	<p>Pulse antenna: The Pulse Antenna is used for all test functions relating to the pulse module – Transponder, DME and TCAS testing. The antenna is mounted on a tripod to allow convenient positioning of the antenna with respect to the aircraft antenna. The Pulse antenna is designed to be highly directional and as such, careful alignment between the ARTS 7000 Pulse antenna and the aircraft system under test antenna is required.</p> <p>NOTE the front of the antenna that should be directed to the antenna under test is the side embossed with the Laversab name and Logo.</p>	123-0230

WARNING

The Pulse Antenna is highly directional and sensitive. Please make sure that visual alignment checks are made before operating this antenna during test function.

Cables



Item	Description	Part Number
1	6 ft Coax Test Cable	117-0487
3	20 ft Coax Test Cable	117-0488
4	60 ft Coax Test Cable	117-0489
5	Power Cables <ul style="list-style-type: none"> i. US Power Cable (6 Feet) ii. UK Power Cable (6 Feet) iii. Europe Power Cable (6 Feet) iv. Swiss Power Cable (6 Feet) v. India Power Cable (6 Feet) vi. China Power Cable (6 Feet) vii. Australia Power Cable (6 Feet) 	<ul style="list-style-type: none"> i. 129-1228 ii. 129-1328 iii. 129-1268 iv. 129-1311 v. 129-1260 vi. 129-1425 vii. 129-1440
Not Shown	External Attenuator	123-0235

Note: Not all items will be included, unless specifically ordered from Laversab.

SUBSECTION 2: HARDWARE & ANTENNA TEST CONFIGURATION

Antenna and Cable configurations by capability

Test Function	Applicable Cable	Antenna to Antenna Over-the-Air connection	Direct Cable Connection	Coupler
	6, 20, 60 ft	Nav/Com: 123-0239 Pulse: 123-0230	Optional Attenuator for Direct Connection	Ant. coupler: 123-0237 GPS coupler: 115-2046
AM	ANY	Nav/Com	As required	N/A
FM	ANY	Nav/Com	As required	N/A
SSB/HF	ANY	Nav/Com	As required	N/A
SelCal	ANY	Nav/Com	As required	N/A
VOR	ANY	Nav/Com	As required	N/A
ILS	ANY	Nav/Com	As required	N/A
Mkr	ANY	Nav/Com	As required	N/A
ELT	ANY	Nav/Com	As required	N/A
Freq Count	ANY	Nav/Com	As required	N/A
Pwr Meter	ANY	Nav/Com	As required	N/A
Freq Scan	ANY	Nav/Com	As required	N/A
DME	ANY	Pulse	As required	Antenna Coupler optional
ATCRBS	ANY	Pulse	As required	Antenna Coupler optional
Mode S	ANY	Pulse	As required	Antenna Coupler optional
ADSB	ANY	Pulse	As required	Antenna Coupler optional
TIS-B	ANY	Pulse	As required	Antenna Coupler optional
Alt. Mon	ANY	Pulse	As required	Antenna Coupler optional
UAT	ANY	Pulse	As required	Antenna Coupler optional
TCAS	ANY	Pulse	As required	N/A
VSWR	ANY	N/A	Required	N/A
DTF	ANY	N/A	Required	N/A
Gain Analyzer	ANY	N/A	Required	N/A
Fixed Mode	ANY	N/A	N/A	GPS Coupler required
Motion Mode	ANY	N/A	N/A	GPS Coupler required

SUBSECTION 3: DIRECT CONNECTIONS AND ANTENNA SET UP

Nav/Com Antenna

While testing over-the-air (e.g. ARTS 7000 antenna to Aircraft under test antenna): For Nav/Com functions connect the antenna part number 123-0239 directly to the antenna port on the top Nav/Com module. Extend the antenna to its fullest length.

If a remote antenna is required. Please select a suitable cable from the supplied coax cables. Connect one end of the cable to the antenna port on the top of the Nav/Com module connect the other end to the antenna tripod adapter. Connect the adapter to the tripod. Attach the Nav/Com telescoping antenna to the adapter and position the tripod/antenna in the desired position.

Pulse Antenna

For Pulse test functions, choose from the cables supplied (best practice is to use the shortest cable that will work for the test setup) to connect to the antenna port of the Pulse module. Connect the other end of the cable to the Pulse antenna. Mount the pulse antenna on the supplied tripod. Position the Pulse antenna so that is directly pointing to the Aircraft antenna to be tested. The optimal distance is 6 feet. Please note the front of the Pulse antenna is embossed with the Laversab name and logo.

Pulse Antenna Alignment, Reflections and Multi-paths (DME / MODE S / ADSB / ATCRBS / UAT / TCAS Testing)

The Pulse antenna is highly directional by design. To achieve good test results, alignment between the Antenna under test and the ARTS 7000 Pulse Antenna must be accurate.

Recommendations:

1. Mount the antenna on the provided tripod and either use the antenna on the ground or fix it to a sturdy gantry.
2. Align the center of the Pulse Antenna as accurately as possible to the antenna under test. Accuracy is required in both the horizontal and vertical plane.
3. A clear line-of-sight is required between the antenna under test and the ARTS 7000 a pulse antenna.
4. Ensure that there are no objects (e.g. tool boxes, ground power units, air stairs, gantries, landing gear etc.) in close proximity to the test transmission path. These items can cause echo and multi-path reflections.
5. Use the shortest test cable possible between the ARTS 7000 and the Pulse Antenna.
6. Include the vertical height and horizontal distance between the antenna under test and the Pulse antenna on the relevant config screen.
7. Update the relevant Config screen with the cable length between the ARTS 7000 and the pulse antenna.
8. Be aware of possible reflective or multipaths affecting the transponder test.

Note: When making tests using the Pulse antenna - if the Power tests fail make a small adjustment to the antenna alignment and re-test.

Antenna Alignment Tool

The ARTS 7000 Application includes an Antenna alignment Tool. This software tool is run automatically when it is required for the test application for example during Mode S testing.

The alignment tool gives an active antenna connection to the aircraft under test and indicates % replies and ERP. This allows the user to adjust the antenna to ensure maximum % replies and ERP. It is highly recommended to use the tool during antenna set up.

Examples of poor Antenna set up or alignment



Antenna Obscured by fin



Landing gear in Line of Sight

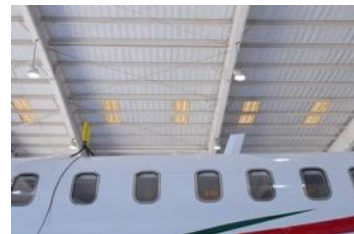

Dangerous Placement

Examples of good Antenna set up or alignment



Good line of sight between Aircraft Antenna under test and ARTS 7000 test antenna.

All Capabilities Direct connection

For direct connection testing – ARTS 7000 Cable connected to an antenna feeder or Unit under test connector.

1. For Nav Com direct connection testing - connect the selected cable from the supplied cables and connect it to the **Direct Connection** on the Nav/Com module. Connect the other end of the cable to the antenna feeder or antenna port on the equipment under test. *Note: Check the power level of the equipment under test. If necessary, please use an external attenuator to ensure the Power level will not damage the ARTS 7000.*
2. For Pulse direct connection testing - connect the selected cable from the supplied cables and connect it to the **Direct Connection** on the Pulse module. Connect the other end of the cable to the antenna feeder or antenna port on the equipment under test. *Note: Check the Power level of the equipment under test. If necessary, please use an external attenuator to ensure the Power level will not damage the ARTS 7000.*

WARNING

When testing with any direct/cable connection - please ensure the power levels to be transmitted to and from the ARTS 7000 are within the stated capability. External attenuators may be required

SECTION 7: ANTENNA COUPLER

SUBSECTION 1: ANTENNA COUPLER DESCRIPTION

Whenever the ARTS 7000 is used to test transponder or DME systems, it is highly recommended to use the Laversab Antenna Coupler. The coupler is designed to clamp onto most shark-fin style antennas. It can be used on Top or Bottom antennas. Correct placement of the coupler is essential to make sure there is no transmission leak.



Item	P/N
Antenna Coupler	123-0237



Coupler in position on the bottom antenna. In this case the coupler is being used as a shield – note the termination is connected on the coupler connector.

The coupler can be used in 2 modes:

1. **Antenna shield.** The coupler can be used to shield a radiating antenna. For example, in testing a diverse Transponder system the Top or Bottom antenna can be shielded to ensure isolation between the antenna under test and the other system antenna. Whenever the coupler is used as a shield the cap must be on the connector. Note the cap is an RF termination at 50 Ohms. Without this connector, tests may be subject to failure.
2. **Standard coupler.** Use of the coupler effectively shields the transmission between the test set and the aircraft. Shielding these transmissions removes or limits the possibility of interference with local ATC operations or active Aircraft TCAS systems. Testing is more consistent and accurate when using the coupler.

SUBSECTION 2: ANTENNA COUPLER SETUP AND OPERATION

The Coupler can be used as a shield or a coupler for MODE S, ADSB, ATRBS and DME tests when the antenna under test is a shark-fin design.

For diverse transponder applications it is advised to use 2 couplers – one as a shield the other as a coupler.

Coupler Set-Up

1. Select a suitable cable for connection from the ARTS to the coupler.
2. Connect a 10dB attenuator to the Cable Port of the ARTS 7000 test set.
3. Connect the cable between the Coupler and the 10dB attenuator.
4. Place the coupler over the aircraft antenna and adjust the clamp for a firm fit.
 - a. Always center the coupler to the aircraft antenna. Ensure the coupler is aligned centrally in both the planes.
 - b. When tightening the clamping screw, do so gently. Over tightening can cause damage to the antenna or the coupler.
 - c. Gently pressing the coupler onto the aircraft skin while tightening the clamp ensures a good seal against the skin of the aircraft.
5. In the ARTS application, select the **Config > Port Selection (Antenna/Cable)**. Choose **Cable w/ Coupler**. If an attenuator is used, please enter the value in **External Attenuator (dB)**, and ensure the correct cable length is entered into **Direct Cable Length**.

WARNING

The Coupler is a heavy item that is often used in high position applications. Ensure the coupler is clamped firmly to the antenna under test and cannot detach from the aircraft. Personnel or equipment could be damaged by a falling coupler.

Whenever possible use additional cable clamps to support the cable and minimize the stain on the coupler.

SECTION 8: INTEGRATED LANDING SYSTEM (ILS) OPERATION

SUBSECTION 1: ILS OPERATION

WARNING

It is extremely dangerous to generate signals during testing that are on the frequencies that are in use by local ATC. When operating the Test Set in ILS Mode please be aware of the local ILS navigation aid and ATC frequencies. It is the test set operator's responsibility to make sure all testing is carried out on frequencies that will not interfere with local navigation aids or ATC resources.

Please See Appendix A for technical specifications.

Test Hardware Required

Item	Test Type	Description / Notes	Part Number
Nav/Com Antenna	Ant - Ant	Telescopic wide frequency band antenna.	123-0239
Antenna Tripod Adapter	Ant - Ant	Optional – Only required for remote ARTS 7000 to antenna connection.	116-0349
Tripod	Ant - Ant	Optional – Only required for remote ARTS 7000 to antenna connection.	118-2286
Coax Cable option of 6, 20 or 60 ft	Ant – Ant	Ant - Ant Optional – Only required for remote ARTS 7000 to antenna connection.	VARIOUS
	Direct Cable	Dir - Cbl – operator choice of length recommended to use shortest possible.	

ILS Test Selection

1. From the Main Menu select **Test Functions**.
2. From the Test Functions menu select **NAV**.
3. From the NAV menu select **ILS**.
4. The ILS test Screen is now displayed.

ILS Configuration

Before running the test, operators can use the default mode by pressing the **Default** button or accessing the config page via the **Config** button to establish the user preferences.

The ARTS 7000 stores the last configuration used and has a default setting. When the **Default** button on the test screen is pressed the ARTS 7000 automatically sets the default mode and settings.

Please See Appendix C for Default and Preset settings.

ILS Configuration Screen

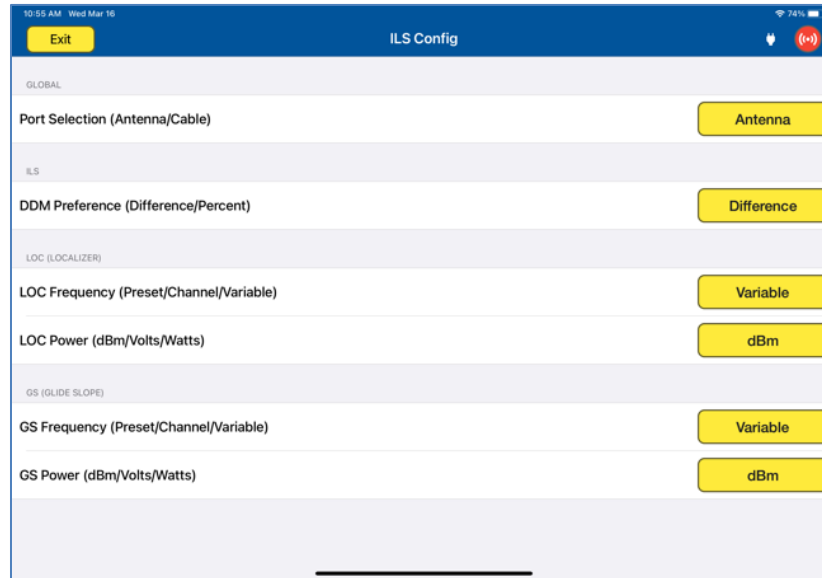

ILS Configuration Controls and Selections





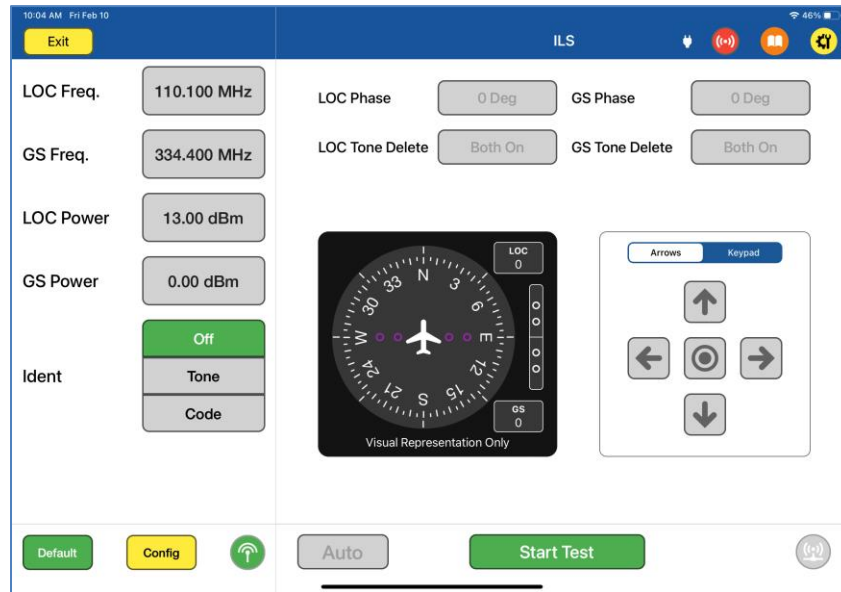

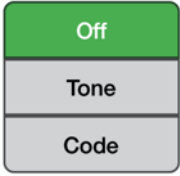

Item	Description
Port Selection (Cable/Antenna)	Selects the over the air (Antenna) connection Port or the Direct (Cable) Connection Port.
DDM Preference (Difference / Percent)	Select the format of Difference in Depth of Modulation.
Loc Frequency (Preset / Channel / Variable)	Allows the selection of the test Localizer Frequency. Preset (Laversab defined) Channel (Standard ILS LOC frequencies) or Variable. See: Appendix C for Laversab Test Default and Preset Frequency Settings
LOC Power (dBm/Volts/Watts)	Allows the selection of the test power units for the Localizer. Selections are dBm, V, or W.
GS Frequency (Preset/Channel /Variable)	Allows the selection of the test Glide Slope Frequency. Preset (Laversab defined) Channel (Standard ILS LOC frequencies) or Variable.
GS Power (dBm/Volts/Watts)	Allows the selection of the test power units for the Glideslope. Selections are dBm, V, W.

ILS Test Screen

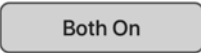
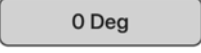
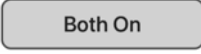

ILS Test Controls and Selections

Item	Description
LOC Freq. <input type="text" value="110.100 MHz"/>	Sets ILS Localizer Frequency. When selected this frequency defines the automatically paired Glide Slope Frequency. If set to a non-active LOC frequency the text font will show in red. <i>During an active test, fine adjustment is available. See below.</i>
GS Freq. <input type="text" value="334.400 MHz"/>	Sets ILS GS Frequency. When selected this frequency defines the automatically paired Localizer Frequency. If set to a non-active GS frequency the text font will show in red. <i>During an active test, fine adjustment is available. See below.</i>
LOC Power <input type="text" value="19.95 mW"/>	Sets the ARTS 7000 output power of the Localizer signal. <i>During an active test, fine adjustment is available. See below.</i>
GS Power <input type="text" value="0.00 dBm"/>	Sets the ARTS 7000 output power of the Glide Slope signal. <i>During an active test, fine adjustment is available. See below.</i>

<p>Ident</p> 	<p>Selects the Audio Identification transmission from the ARTS 7000.</p> <p>Options are: Off, Tone (1KHz steady tone) or Code (Morse - LSB).</p> <p>When Code is selected the repetition rate is set at 30 seconds. The user can trigger an immediate Code transmission by pressing the Code button. whenever the Code button is pushed the ARTS will immediately transmit the Code signal.</p>
<p>LOC Phase</p> 	<p>LOC Phase adjusts the phase relationship between the 90 & 150Hz tones.</p>
<p>LOC Tone Delete</p> 	<p>Selects the removal of the 90Hz, 150Hz, or both 90Hz and 150Hz elements of the Localizer.</p> <p>Used to confirm receiver fail indication on loss of a valid signal element.</p>
<p>GS Phase</p> 	<p>GS Phase adjusts the phase relationship between the 90 & 150Hz tones.</p>
<p>GS Tone Delete</p> 	<p>Selects a menu to allow the removal the 90Hz, 150Hz, or both 90Hz and 150Hz elements of the Glide Slope.</p> <p>Used to confirm receiver fail indication on loss of a valid signal element.</p>
	<p>Steps the Localizer 1 Step to the Left. Step size is selected from the Config Page.</p>
	<p>Steps the Localizer 1 Step to the Right. Step size is selected from the Config Page.</p>
	<p>Sets the ILS Signal (both Localizer and Glide Slope Signals) to the Center position.</p>
	<p>Steps the Glide Slope up by one increment. Step size is selected from the Config Page.</p>
	<p>Steps the Glide Slope down by one increment. Step size is selected from the Config Page.</p>
	<p>This indicator shows the active selected Localizer deviation.</p>

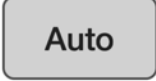
	This indicator shows the active selected Glide Slope deviation.
	Runs the ILS Auto test sequence.

SUBSECTION 2: ILS TEST CONTROL AND OPERATION DETAILS

1. **LOC Freq.:** Sets the frequency of the ARTS 7000 generated Localizer. Automatically sets the linked ARTS 7000 Glide Slope frequency.

- a. Note: when the test is running the Frequency can be course and fine-tuned to allow selectivity testing. This done by pushing the Frequency numerical field:

110.100 MHz

A pop-up is then displayed to allow live course and fine adjustment of the Transmitted Frequency.

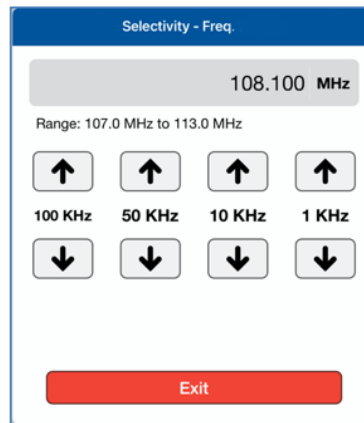

Frequency Selectivity pop-up for Selectivity testing.

- b. If a non-active LOC Frequency is selected the numerical display will be shown in a red font.
2. **GS Freq.:** Sets the frequency of the ARTS 7000 generated Glide Slope.

- a. Note: when the test is running the Frequency can be course and fine-tuned to allow selectivity testing. This done by pushing the Frequency numerical field:

334.400 MHz

A pop-up is then displayed to allow live course and fine adjustment of the Transmitted Frequency.

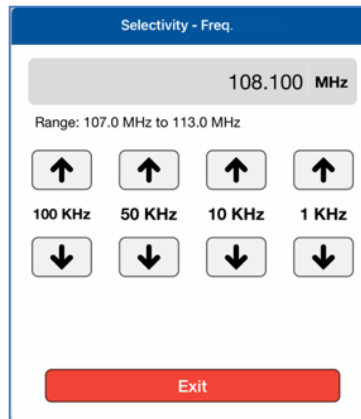

Frequency Selectivity pop-up for Selectivity testing.

- b. If a non-active GS Frequency is selected the numerical display will be shown in a red font
3. **LOC Power:** Sets the power of the ARTS 7000 generated Localizer signal.
 - a. Note: when the test is running the Power can be course and fine-tuned to allow sensitivity testing. This done by pushing the Power numerical field:

19.95 mW

A pop-up is then displayed to allow live course and fine adjustment of the Transmitted Power.

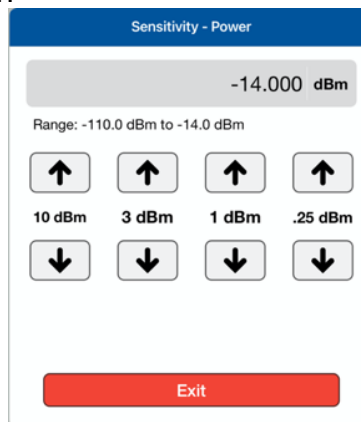

Pop-up for Sensitivity testing.

4. **GS Power:** Sets the power of the ARTS 7000 generated Glide Slope signal.
 - a. Note: when the test is running the Power can be course and fine-tuned to allow sensitivity testing. This done by pushing the Power numerical field:

0.00 dBm

A pop-up is then displayed to allow live course and fine adjustment of the Transmitted Power.

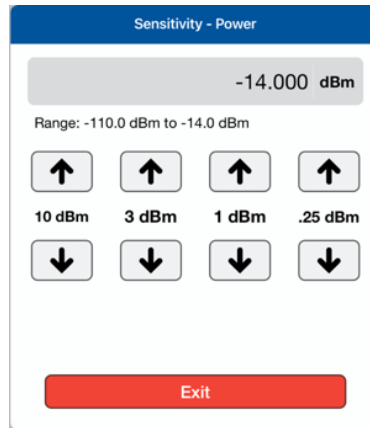

Pop-up for Sensitivity testing.

5. **Ident:** Allows the use to select the audio identifier of the ARTS 7000 generated ILS signal. Possible Selections are:
 - a. **Off** – No Audio Ident
 - b. **Code** – the ARTS 7000 generates a repetitive Morse code identification signal comprising the letters LSB. This LSB morse signal is sent every 30 seconds. he morse can be instantly transmitted manually by pressing the **Code** button.
 - c. **Tone** – the ARTS 7000 generates a constant 1 kHz audio tone.

SUBSECTION 3: ILS TEST OPERATION ACTIVE TEST CONTROL AND INDICATORS

1. **LOC Phase:** Allows the phase difference between the Localizer 90 & 150 Hz signals to be adjusted. From 0 Degrees to 120 Degrees in 2-degree steps. This function allows the operator to simulate the phase difference between the 90 & 150 Hz signals when an aircraft is turning into the localizer beam for capture on ILS approach.
2. **LOC Tone Delete:** Gives the operator control of the 90 and 150 Hz Localizer signals. This function is used to test the response of the radio when an invalid signal is received. Cockpit warning/fail flags should be displayed when any element of the 90 and 150Hz signals re deleted. The aircraft receiver should extinguish warning/fail flags when the valid signal is returned.
Possible selections are:
 - a. **90Hz** – Switches off the 90 Hz element.
 - b. **150Hz** – Switches off the 150 Hz element.
 - c. **Both** – Switches off both the 90 and 150 Hz elements.
3. **LOC DDM:** Indicates the current DDM when the test is active. This field is updated as the Localizer is moved across its range.
4. **G/S Phase:** Allows the phase difference between the Glide Slope 90 & 150 Hz signals to be adjusted. From 0 degrees to 120 Degrees in 2-degree steps. This function allows the operator to simulate the phase difference between the 90 & 150 Hz signals when an aircraft is capturing the Glide Slop beam on an ILS approach.
5. **G/S Tone Delete:** Gives the operator control of the 90 and 150 Hz Glide Slope signals. This function is used to test the response of the radio when an invalid signal is received.

Cockpit warning/fail flags should be displayed when any element of the 90 and 150Hz signals re deleted. The aircraft receiver should extinguish warning/fail flags when the valid signal is returned.

Possible selections are:

- a. **90 Hz** – Switches off the 90 Hz element.
 - b. **150 Hz** – Switches off the 150 Hz element.
 - c. **Both** – Switches off both the 90 and 150 Hz elements.
6. **G/S DDM**: Indicates the current DDM of the Glide Slope when the test is active. This field is updated as the Glide Slope is moved across its range.
7. **AUTO**: when the Auto function is enabled the ARTS 7000 sets up Localizer and Glideslope signals IAW the preset Frequencies and Power. The ILS signal from the ARTS 7000 then imitates a corkscrew-type motion of the Localizer and Glideslope. This simulates the aircraft capturing the Localizer and Glideslope and “flying” a corkscrew path into the Center point of the ILS. Once the Center point is reached the signals will be reversed and the aircraft should indicate “flying” out in a corkscrew fashion to the outer limits of the ILS indicator. This process is continuous until the Auto is switched off. This function is intended to fully exercise the ILS system, continuously and can be used to troubleshoot poor connections or damaged cables.

SECTION 9: MARKER BEACON (MKR) OPERATION

SUBSECTION 1: MKR BEACON OPERATION

WARNING

It is extremely dangerous to generate signals during testing that are on the frequencies that are in use by local ATC. When operating the Test Set in MKR Mode please be aware of the location of local MKR beacons. It is the test set operator's responsibility to make sure all testing is carried out in such a way that the testing that will not interfere with local navigation aids or ATC resources.

Please See Appendix A for technical specifications.

Test Hardware Required

Item	Test Type	Description / Notes	Part Number
Nav Com Antenna	Ant - Ant	Telescopic wide frequency band antenna.	123-0239
Antenna Tripod Adapter	Ant - Ant	Optional – Only required for remote ARTS 7000 to antenna connection.	116-0349
Tripod	Ant - Ant	Optional – Only required for remote ARTS 7000 to antenna connection.	118-2286
Coax Cable option of 6, 20 or 60 ft	Ant – Ant Direct Cable	Ant - Ant Optional – Only required for remote ARTS 7000 to antenna connection. Dir - Cbl – operator choice of length recommended to use shortest possible.	VARIOUS

Mkr Beacon Test Selection

1. From the Main Menu select **Test Functions**.
2. From the Functions menu select **NAV**.
3. From the NAV menu select **MKR**.
4. The MKR test Screen is now displayed.

Mkr Configuration

Before running the test, operators can use the default mode by pressing the **Default** button or accessing the config page via the **Config** button to establish the user preferences.

The ARTS 7000 stores the last configuration used and has a default setting. When the **Default** button on the test screen is pressed the ARTS 7000 automatically sets the default mode and settings.

Please See Appendix C for Default and Preset settings.

Mkr Configuration Screen

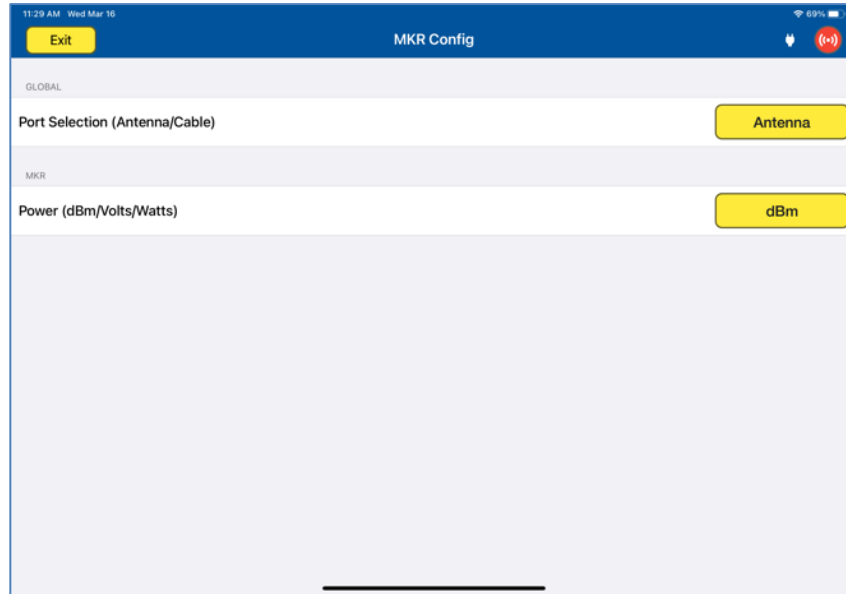

Mkr Configuration Controls and Selections

Item	Description
Port Selection (Cable/Antenna)	Selects the over the air (Antenna) connection Port or the Direct (Cable) Connection Port.
Power (dBm/Volts/Watts)	Allows the selection of the test power units for the Mkr Beacon. Selections are dBm, Volts, Watts.

Mkr Test Screen

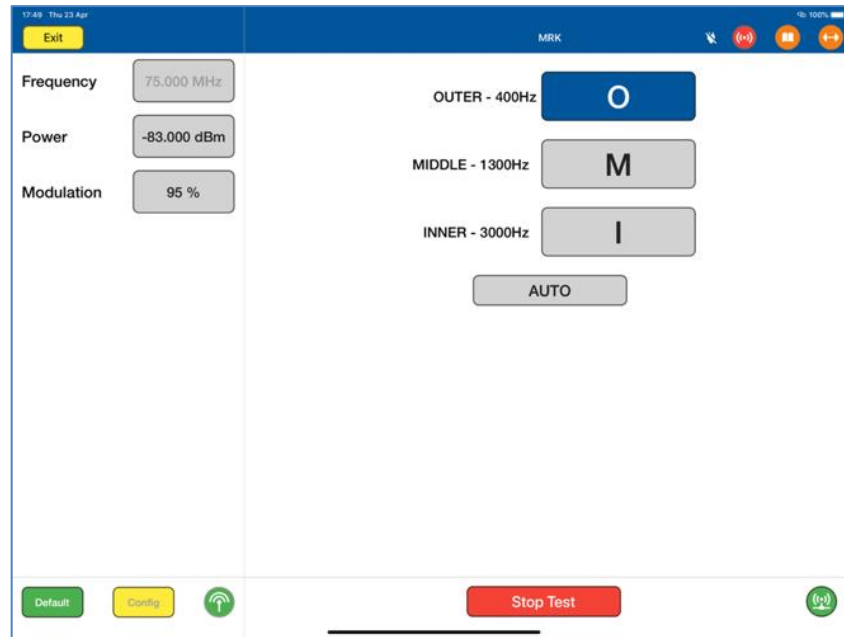

Mkr Test Controls and Selections

Item	Description
Frequency <input type="text" value="75.000 MHz"/>	Sets Mkr Frequency. Fixed at 75 MHz. During an active test, fine adjustment is available. See below.
Power <input type="text" value="-83.000 dBm"/>	Sets the ARTS 7000 output power of the Mkr Beacon signal. During an active test, fine adjustment is available. See below.
Modulation <input type="text" value="95 %"/>	Sets the ARTS 7000 Mkr Modulation
OUTER - 400Hz <input checked="" type="checkbox" value="O"/>	Enables an active Outer 400 Hz Marker signal. Signal is active when highlighted with the color Blue.
MIDDLE - 1300Hz <input checked="" type="checkbox" value="M"/>	Enables an active Middle 1300Hz Marker signal. Signal is active when highlighted with the color Orange.
INNER - 3000Hz <input type="checkbox" value="I"/>	Enables an active Inner 3000Hz Marker signal. Signal is active when highlighted with the color White.

<div style="border: 1px solid gray; border-radius: 10px; padding: 5px; width: 100px; margin: 0 auto;"> AUTO </div>	Toggles ON / OFF the Automatic Mkr Beacon function
---	--

SUBSECTION 2: MKR TEST CONTROL DETAILS

1. **Frequency:** Sets the frequency of the ARTS 7000 generated Marker Beacon frequency. This frequency is adjustable from 72.000 MHz to 78.000 MHz. 75MHz is the standard frequency.
 - a. Note: when the test is running the Frequency can be course and fine-tuned to allow selectivity testing. This done by pushing the Frequency numerical field:

75.000 MHz

A pop-up is then displayed to allow live course and fine adjustment of the Transmitted Frequency.

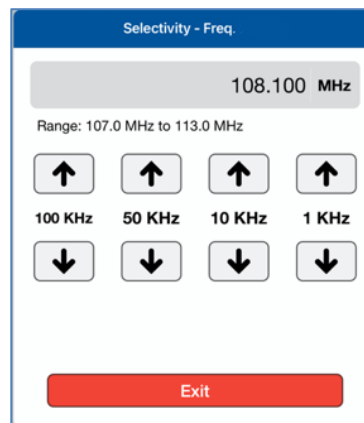

Frequency Selectivity pop-up for Selectivity testing.

- b. If a non-active Mkr Frequency is selected the numerical display will be shown in a red font.
2. **Power:** Sets the power of the ARTS 7000 generated Marker Beacon signal.
 - a. Note: when the test is running the Power can be course and fine-tuned to allow sensitivity testing. This done by pushing the Power numerical field:

0.00 dBm

A pop-up is then displayed to allow live course and fine adjustment of the Transmitted Power.

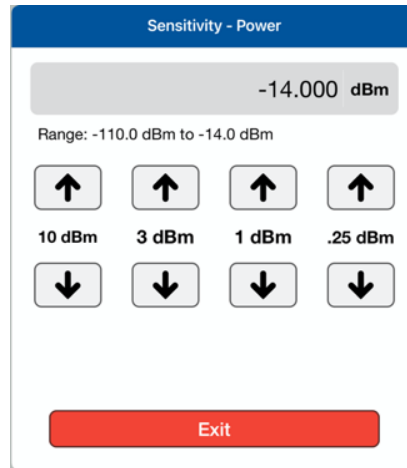

Pop-up for Sensitivity testing.

3. **Modulation:** Sets the modulation depth of the ARTS 7000 generated Marker Beacon Signal.
4. **Outer 400Hz:** When the test is running this button is used to toggle the Outer Marker signal on and off. When the Outer Marker signal is active the button will be highlighted in Blue
5. **Middle 1300Hz:** When the test is running this button is used to toggle the Middle Marker signal on and off. When the Middle Marker signal is active the button will be highlighted in Orange.
6. **Inner 3000Hz:** When the test is running this button is used to toggle the Inner Marker signal on and off. When the Inner Marker signal is active the button will be highlighted in White.
7. **Auto:** Toggles the Automatic Mkr test function On and Off. When Auto is selected the Marker Beacon signals generated from the ARTS 70000 will cycle through Outer, Middle and Inner signals with a gap of approximately 2 seconds.

SECTION 10: ILS AND MKR OPERATION

SUBSECTION 1: ILS AND MKR BEACON OPERATION

WARNING

It is extremely dangerous to generate signals during testing that are on the frequencies that are in use by local ATC. When operating the Test Set in a Mkr Mode please be aware of the location of local Mkr beacons. It is the test set operator's responsibility to make sure all testing is carried out in such a way that the testing that will not interfere with local navigation aids or ATC resources.

Please See Appendix A for technical specifications.

Test Hardware Required

Item	Test Type	Description / Notes	Part Number
Nav Com Antenna	Ant - Ant	Telescopic wide frequency band antenna.	123-0239
Antenna Tripod Adapter	Ant - Ant	Optional – Only required for remote ARTS 7000 to antenna connection.	116-0349
Tripod	Ant - Ant	Optional – Only required for remote ARTS 7000 to antenna connection.	118-2286
Coax Cable option of 6, 20 or 60 ft	Ant – Ant Direct Cable	Ant - Ant Optional – Only required for remote ARTS 7000 to antenna connection. Dir - Cbl – operator choice of length recommended to use shortest possible.	VARIOUS

Mkr Beacon Test Selection

1. From the Main Menu select **Test Functions**.
2. From the Functions Menu select **NAV**.
3. From the NAV menu select **ILS & MKR**.
4. The ILS & MKR test Screen is now displayed.



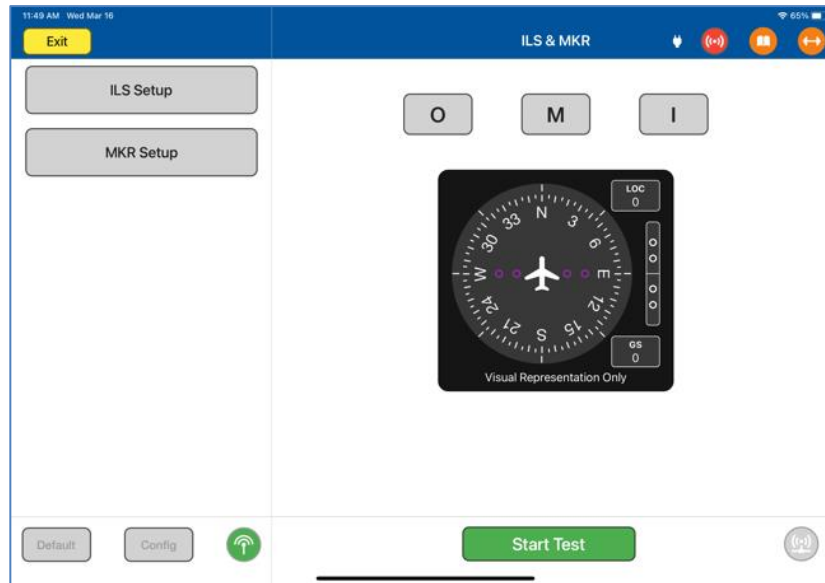

ILS & Mkr Configuration and Operation.

There is no specific configuration for the ILS & MKR. The test set configurations are set by selecting the ILS or MKR buttons on the left-hand side of the test screen. This brings up the relevant test screen for the capability. All configuration and set up is then completed on the specific test screen - either the ILS or the MKR Test Screen. Both ILS and MKR must be setup to successfully run the test. When  is pressed, the operator is returned to the ILS & MKR test screen.

ILS & Mkr Test Screen

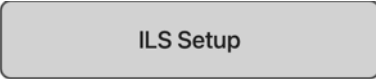
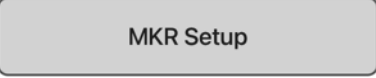

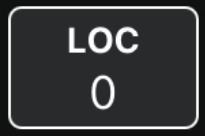
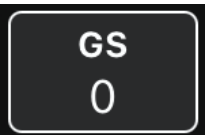

ILS & Mkr Test Controls and Selections

Item	Description
	Selects the ILS Test Screen. This allows any configuration changes or test attributes to be set for the ILS portion of the test. Exiting from the ILS test screen returns the user to the ILS & MKR Test Screen.
	Selects the MKR Test Screen. This allows any configuration changes or test attributes to be set for the MKR portion of the test. Exiting from the MKR test screen returns the user to the ILS & MKR Test Screen.
	Enables an active Outer 400 Hz Marker signal. Signal is active when highlighted with the color Blue.
	Enables an active Middle 1300Hz Marker signal. Signal is active when highlighted with the color Orange.
	Enables an active Inner 3000Hz Marker signal. Signal is active when highlighted with the color White.

	This indicator shows the active selected Localizer deviation.
	This indicator shows the active selected Glide Slope deviation.

SUBSECTION 2: ILS & MKR TEST CONTROL DETAILS

1. Please see the relevant ILS and MKR Test sections for details of operation.
2. The ILS & MKR test is an automatic test function.

When  is selected the ILS and MKR become operational. The Localizer and G/S will enter an automatic pattern effectively sweeping the Localizer and G/S across the relevant DDM. The MKR beacons will light sequentially every time the G/S crosses the center line. The ILS & MKR test will continue to run the ILS sweep pattern and illuminate the MKR beacons continuously until  is selected.

SECTION 11: VHF OMNIDIRECTIONAL RANGING (VOR) OPERATION

SUBSECTION 1: VOR OPERATION

WARNING

It is extremely dangerous to generate signals during testing that are on the frequencies that are in use by local ATC. When operating the Test Set in VOR Mode please be aware of the local VOR navigation aid and ATC frequencies. It is the test set operator's responsibility to make sure all testing is carried out on Frequencies that will not interfere with local navigation aids or ATC resources.

Please See Appendix A for technical specifications.

Test Hardware Required

Item	Test Type	Description / Notes	Part Number
Nav Com Antenna	Ant - Ant	Telescopic wide frequency band antenna.	123-0239
Antenna Tripod Adapter	Ant - Ant	Optional – Only required for remote ARTS 7000 to antenna connection.	116-0349
Tripod	Ant - Ant	Optional – Only required for remote ARTS 7000 to antenna connection.	118-2286
Coax Cable option of 6, 20 or 60 ft	Ant – Ant Direct Cable	Ant - Ant Optional – Only required for remote ARTS 7000 to antenna connection. Dir - Cbl – operator choice of length recommended to use shortest possible.	VARIOUS

VOR Test Selection

1. From the Main Menu select **Test Functions**.
2. From the Functions Menu select **NAV**.
3. From the NAV menu select **VOR**.
4. The VOR test Screen is now displayed.

VOR Test Configuration

Before running the test, operators can use the default mode by pressing the **Default** button or accessing the config page via the **Config** button to establish the user preferences.

The ARTS 7000 stores the last configuration used and has a default setting. When the **Default** button on the test screen is pressed the ARTS 7000 automatically sets the default mode and settings.

Please See Appendix C for Default and Preset settings.

VOR Test Configuration Screen

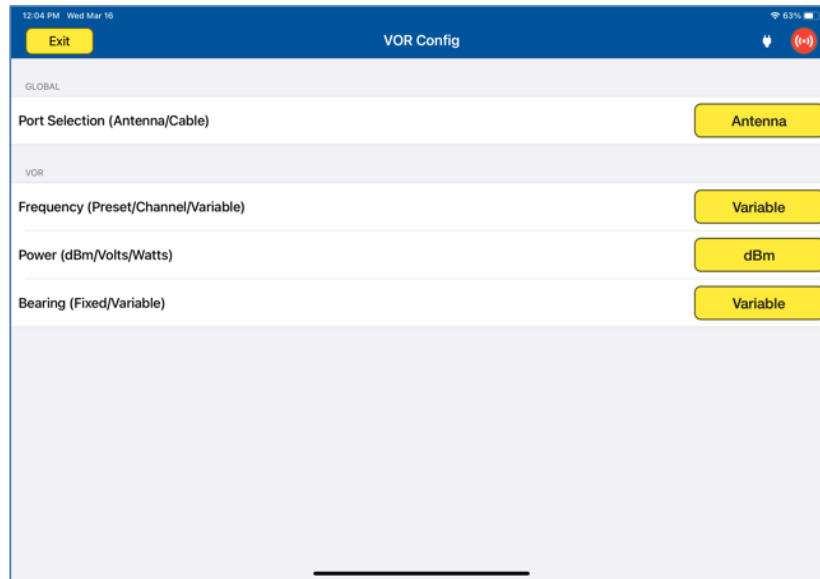

VOR Test Configuration Controls and Selections





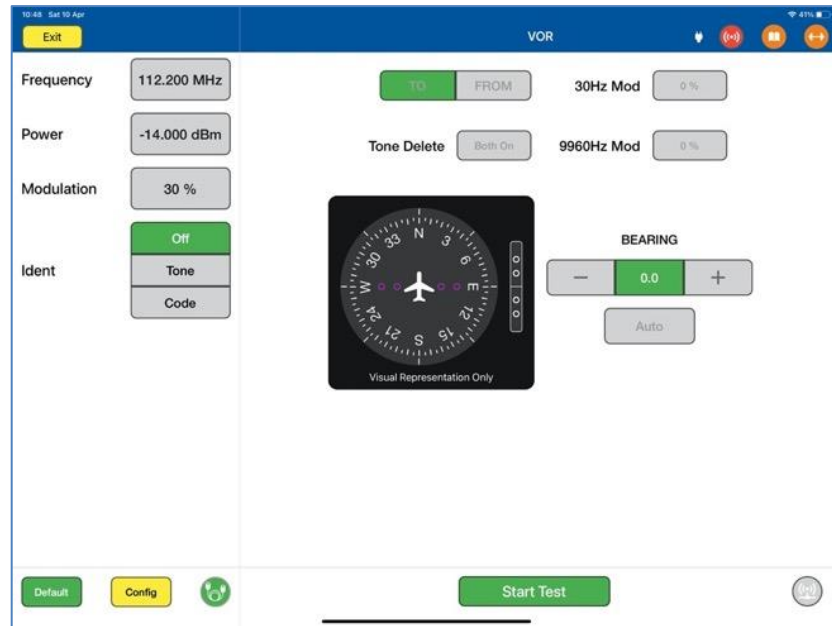

Item	Description
Port Selection (Cable/Antenna)	Selects the over the air (Antenna) connection Port or the Direct (Cable) Connection Port.
Frequency (Preset/Channel/Variable)	Allows the selection of the test VOR Frequency. Selections are Preset (Laversab-defined), Channel (Standard VOR frequencies) or Variable.
Power (dBm/Volts/Watts)	Allows the selection of the test power units for the VOR Signal. Selections are dBm, Volts, or Watts.
Bearing (Fixed/Variable)	Selects the bearing to be stepped in 10 deg steps (Fixed) or by 0.1 deg steps (Variable).

VOR Test Screen

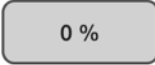
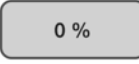

VOR Test Controls and Selections

Item	Description
Frequency <input type="text" value="108.200 MHz"/>	Sets Frequency of the ARTS 7000 Generated VOR signal During an active test, fine adjustment is available. See below.
Power <input type="text" value="-15.000 dBm"/>	Sets the output power of the ARTS 7000 generated VOR signal. During an active test, fine adjustment is available. See below.
Modulation <input type="text" value="30 %"/>	Sets the Modulation depth of the VOR signal. During an active test, fine adjustment is available. See below.
Ident <input type="button" value="Off"/> <input type="button" value="Tone"/> <input type="button" value="Code"/>	Selects the Audio Identification transmission from the ARTS 7000. Options: Off , Tone (1KHz steady tone) or Code (Morse - LSB). When Code is selected the repetition rate is set at 30 seconds. The user can trigger an immediate Code transmission by pressing the Code button. Whenever the Code button is pushed the ARTS will immediately transmit the Code signal.

	<p>Selects the VOR signal as 'To' the beacon or 'From' the beacon signal.</p>
<p>Tone Delete </p>	<p>Selects the removal of the 30Hz reference, 30Hz variable or both 30Hz elements of the VOR Signal. Used to confirm receiver fail indication on loss of a valid signal element.</p>
<p>30Hz Mod </p>	<p>Allows adjustment of the modulation of the 30Hz variable Modulation Depth</p>
<p>9960Hz Mod </p>	<p>Allows adjustment of the modulation of the 9960Hz sub carrier Modulation Depth</p>
	<p>Indicates the current bearing of the VOR signal being transmitted from the ARTS 7000. Under normal test condition the aircraft display should show this bearing.</p>
	<p>Steps the VOR Bearing anti-clockwise by 1 increment. Step size is selected from the Config Page.</p>
	<p>Steps the VOR Bearing clockwise by 1 increment. Step size is selected from the Config Page.</p>
	<p>Toggles ON and OFF the Automatic VOR test function.</p>

SUBSECTION 2: VOR TEST CONTROL DETAILS

1. **Frequency:** Sets the frequency of the ARTS 7000 generated VOR frequency.

- a. Note: when the test is running the Frequency can be course and fine-tuned to allow selectivity testing. This done by pushing the Frequency numerical field:

110.100 MHz

A pop-up is then displayed to allow live course and fine adjustment of the Transmitted Frequency.

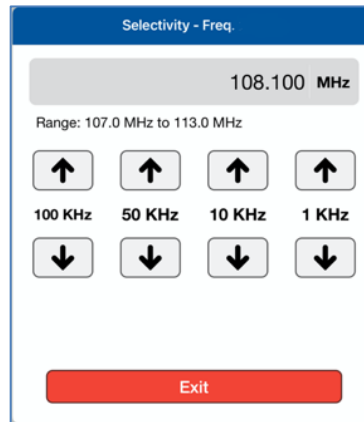

Frequency Selectivity pop-up for Selectivity testing.

- b. If a non-active VOR Frequency is selected the numerical display will be shown in a red font

2. **Power:** Sets the power of the ARTS 7000 generated VOR signal.

- a. Note: when the test is running the Power can be course and fine-tuned to allow sensitivity testing. This done by pushing the Power numerical field:

0.00 dBm

A pop-up is then displayed to allow live course and fine adjustment of the Transmitted Power.

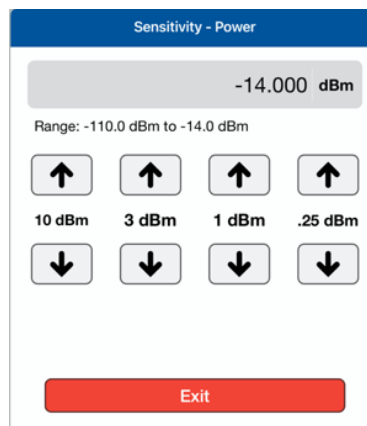

Pop-up for Sensitivity testing.

3. **Modulation:** Allows adjustment of the master modulation depth of the combined elements of the VOR signal.
4. **Ident:** Allows selection of the audio identifier of the ARTS 7000 generated VOR signal. Possible selections are:
 - a. **Off** – No Audio Ident
 - b. **Code** – the ARTS 7000 generates a repetitive Morse code identification signal comprising the letters LSB. This LSB morse signal is sent every 30 seconds. The morse can be instantly transmitted manually by pressing the **Code** button.
 - c. **Tone** – the ARTS 7000 generates a constant 1 kHz audio tone.
5. **To/From:** Allows the selection of either:
 - a. To the Beacon (ARTS 7000) indication.
 - b. From the Beacon (ARTS 7000) indication.
6. **Tone Delete:** Gives the operator control of the 30Hz reference and 30Hz Variable elements of the VOR signal. This function is used to test the response of the radio when an invalid signal is received. Cockpit warning/fail flags should be displayed when any element of the two 30Hz signals are deleted. The aircraft receiver should extinguish warning/fail flags when the valid signal is returned. Possible selections are:
 - a. **Both On** – Leaves On both the 30Hz Reference and Variable elements.
 - b. **Both Off** – Switches Off both the 30Hz Reference and Variable elements.
 - c. **REF** – Switches Off the 30Hz Reference element.
 - d. **VAR** – Switches Off the 30Hz Variable element.
7. **30Hz Mod:** This setting allows control over the 30Hz variable phase modulation depth.
8. **9960Hz Mod:** This setting allows control over the 9960Hz sub-carrier modulation depth.
9. **AUTO** – When the Auto function is enabled the ARTS 7000 sets up a VOR signal in accordance with the selected frequencies, Power Modulation, and Ident settings. The VOR signal from the ARTS 7000 automatically steps the Bearing from 0 deg to 360 deg. Once the full-scale sweep is complete, the VOR signal is reversed from 360 deg to 0 deg. The ARTS 7000 will continue to sweep the bearing through full range until the Auto button is pressed again. This function exercises the instrumentation across full scale and simulates the aircraft flying in a circular motion around a VOR beacon. This process will continue to run until Auto is disabled. This function is intended to fully exercise the VOR system continuously and can be used to troubleshoot poor connections or damaged cables.

SECTION 12: VHF COM AMPLITUDE MODULATION (AM)

SUBSECTION 1: COM VHF AM OPERATION

WARNING

It is extremely dangerous to generate signals during testing that are on the frequencies that are in use by local ATC. When operating the Test Set in COM Mode please be aware of the local COM ATC frequencies. It is the test set operator's responsibility to make sure all testing is carried out on Frequencies that will not interfere with local navigation aids or ATC resources.

Please See Appendix A for technical specifications.

Test Hardware Required

Item	Test Type	Description / Notes	Part Number
Nav Com Antenna	Ant - Ant	Telescopic wide frequency band antenna.	123-0239
Antenna Tripod Adapter	Ant - Ant	Optional – Only required for remote ARTS 7000 to antenna connection.	116-0349
Tripod	Ant - Ant	Optional – Only required for remote ARTS 7000 to antenna connection.	118-2286
Coax Cable option of 6, 20 or 60 ft	Ant – Ant Direct Cable	Ant - Ant Optional – Only required for remote ARTS 7000 to antenna connection. Dir - Cbl – operator choice of length recommended to use shortest possible.	VARIOUS

COM VHF AM Test Selection

1. From the Main Menu Select **Test Functions**.
2. From the Functions Menu select **COM**.
3. From the COM menu select **AM**.
4. The AM test Screen is now displayed.

COM AM Test Configuration

Before running the test, operators can use the default mode by pressing the **Default** button or accessing the config page via the **Config** button to establish the user preferences.

The ARTS 7000 stores the last configuration used and has a default setting. When the **Default** button on the test screen is pressed the ARTS 7000 automatically sets the default mode and settings.

Please See Appendix C for Default and Preset settings.

COM AM Test Configuration Screen

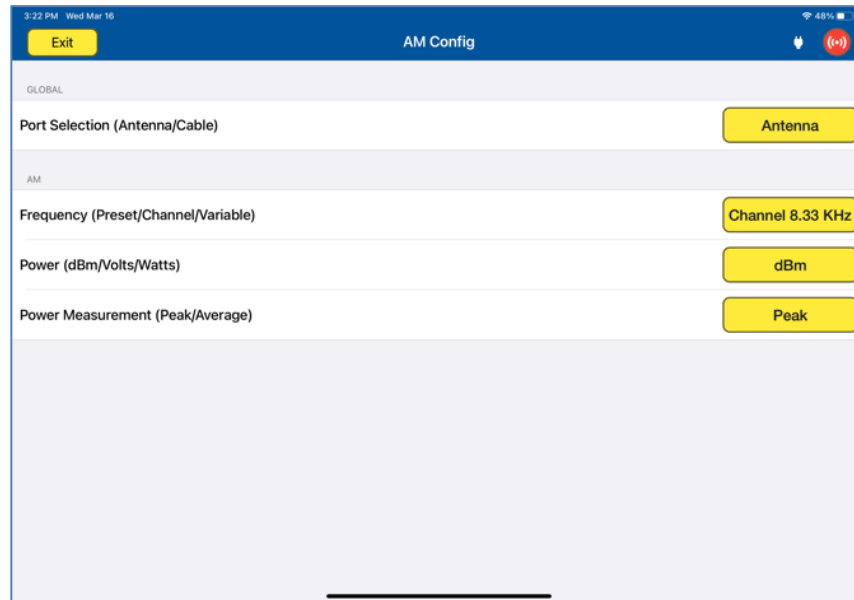

COM AM Test Configuration Controls and Selections

Item	Description
Port Selection (Cable/Antenna)	Selects the over the air (Antenna) connection Port or the Direct (Cable) Connection Port.
Frequency (Preset/Channel/Variable)	Allows the selection of the Test COM AM Frequency. Selections are Preset (Laversab-defined), Channel (Standard COM AM frequencies) or Variable.
Power (dBm/Volts/Watts)	Allows the selection of the test power units for the COM AM Signal. Selections are dBm, Volts, Watts
Power Measurement (Peak/Average)	Selects methodology for power measurement during cable connected tests. Selections are Peak Power or Average Power.

COM AM Test Screens

Please note: the test screens differ between the main set up page, Transmit mode and Receive mode.



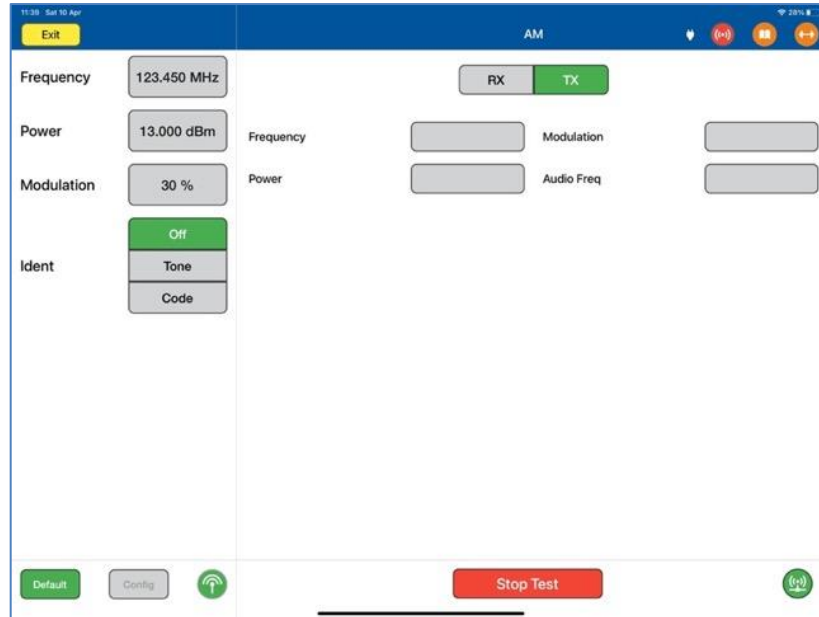

Main test screen and Screen during TX (Transmit)

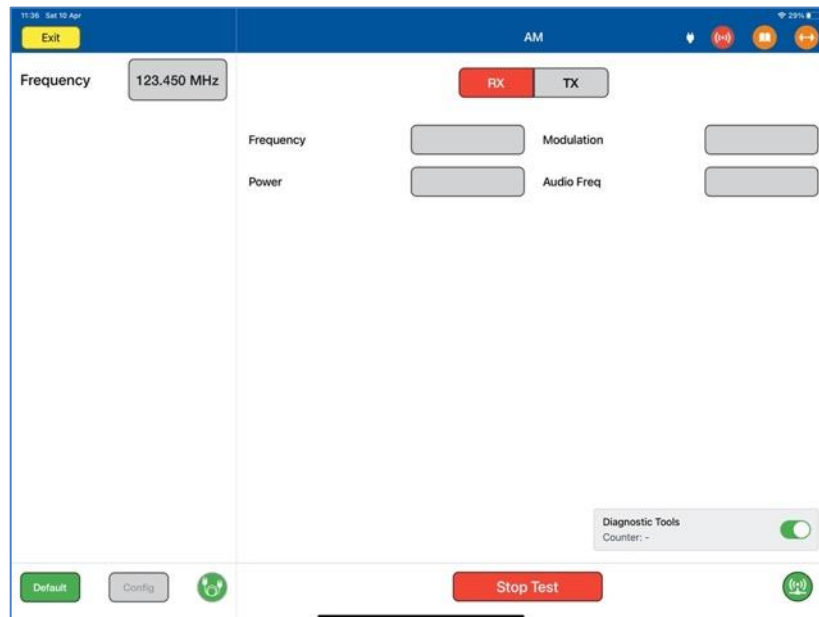

Test Screen during Receive (RX) Mode

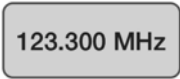

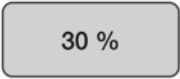
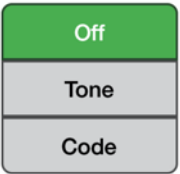
COM AM Test Controls and Selections

Item	Description
Frequency 	Sets Frequency of the ARTS 7000 Generated COM AM signal <i>During an active test, fine adjustment is available. See below.</i>
Power 	Sets the output power of the ARTS 7000 generated COM AM signal. <i>Not shown in Rx mode.</i> <i>During an active test, fine adjustment is available. See below.</i>
Modulation 	Sets the Modulation depth of the VOR signal. <i>Not shown in Rx mode.</i> <i>During an active test, fine adjustment is available. See below.</i>
Ident 	Selects the Audio Identification transmission from the ARTS 7000. <i>Not shown in Rx mode.</i> Options are: Off , Tone (1KHz steady tone) or Code (Morse - LSB). When Code is selected the repetition rate is set at 30 seconds. The user can trigger an immediate Code transmission by pressing the Code button. Whenever the Code button is pushed the ARTS will immediately transmit the Code signal.
	Toggles the ARTS 7000 from Receive to Transmit mode. On start-up the ARTS 7000 is always in Receive mode.
Frequency	During an active test this field will indicate the Transmitted Frequency from the Aircraft.
Power	During an active test this field will indicate the Power transmitted from the Aircraft. This is only available on Direct (cable) connections.
Modulation	During an active test this field will indicate the Modulation depth of Transmitted signal from the Aircraft.
Audio Frequency	During an active test this field will indicate the approximate transmitted Audio Frequency from the Aircraft.

Diagnostic Tools Counter: - 	Diagnostic tools for Frequency and Power checks. Only Active in Rx mode. See below for details.
--	---

SUBSECTION 2: COM AM TEST CONTROL DETAILS

1. **Frequency:** Sets the frequency of the ARTS 7000 generated COM AM frequency.
 - a. Note: when the test is running the Frequency can be course and fine-tuned to allow selectivity testing. This done by pushing the Frequency numerical field:

110.100 MHz

A pop-up is then displayed to allow live course and fine adjustment of the Transmitted Frequency.

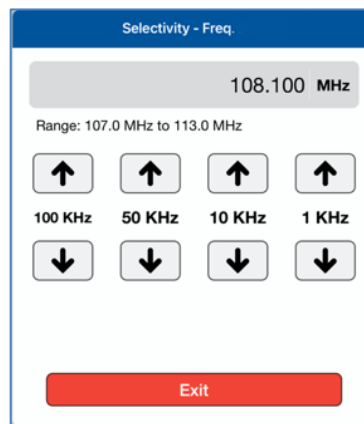

Frequency Selectivity pop-up for Selectivity testing.

2. **Power:** Sets the power of the ARTS 7000 generated COM AM signal.
 - a. Note: when the test is running the Power can be course and fine-tuned to allow sensitivity testing. This done by pushing the Power numerical field:

0.00 dBm

A pop-up is then displayed to allow live course and fine adjustment of the Transmitted Power.

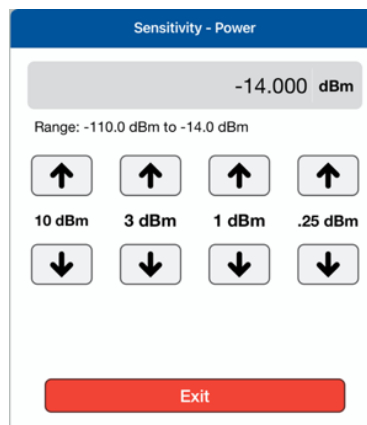

Pop-up for Sensitivity testing.

3. **Modulation:** Allows adjustment of the master modulation depth of the COM AM signal.
4. **Ident:** Allows the user to select the audio identifier of the ARTS 7000 generated AM signal. Possible Selections are:
 1. **Off** – No Audio Ident
 2. **Code** – the ARTS 7000 generates a repetitive Morse code identification signal comprising the letters LSB. This LSB morse signal is sent every 30 seconds. The morse can be instantly transmitted manually by pressing the **Code** button.
 3. **Tone** – the ARTS 7000 generates a constant 1 kHz audio tone.
5. **Frequency** (indicator): Indication of the received frequency from the Aircraft transceiver. This field is only active when the ARTS 7000 is in receive mode and receives a signal from the aircraft when PTT is active.
6. **Power** (indicator): Provides a power measurement indication of the signal received from the aircraft. This function is only active when the ARTS 7000 is in receive mode and receives a signal from the aircraft when PTT is active. Note: this function is only active when the ARTS 7000 is configured in a direct (Cable) connection to the aircraft transceiver.
7. **Modulation** (indicator): This indicator gives the depth of modulation of the transmitted signal from the aircraft. This field is only active when the ARTS 7000 is in receive mode and receives a signal from the aircraft when PTT is active.
8. **Audio Freq** (indicator): This indicator gives the depth of modulation of the transmitted signal from the aircraft. This field is only active when the ARTS 7000 is in receive mode and receives a signal from the aircraft when PTT is active.

SUBSECTION 3: DIAGNOSTIC TOOLS

Screen Shots of Diagnostic Tools Selection

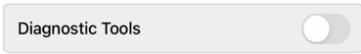
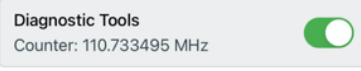
	Diagnostic Tools Off
	Diagnostic tools On Counter Display Shown.

The ARTS 7000 Test Application includes diagnostic tools that can be used when the ARTS 7000 is in any COM VHF or HF receive mode. The Tools are only available when indicated in the bottom right corner of the test screen.

The only applicable tools will be displayed for the required test. Enabling these tools can help identify tuning errors, antenna issues, unstable transmitters, transmitters with drift, and verification checks for received frequencies and power. The Diagnostic Tools can be used at any time in RX, but they may be most helpful when the ARTS is unable to display “received” Frequency or Power values.

Diagnostics Mode Counter

The Counter measures the transmitted frequency from the Aircraft Radio. It may show a different value than the main test frequency. The counter has a wider band than the Main ARTS receiver.

1. If many frequencies are received the reading may fluctuate and not be useful.
2. If the received frequency is stable, this will be useful for comparison. If the Aircraft Radio is good the counter frequency and test page frequency should match.
3. If the counter frequency is more than +/-10KHz from the main test frequency, the main test frequency will not be displayed. Modulation and power values may be displayed, but they may not be correct. To fix this condition, verify that the aircraft radio is tuned correctly. If it is tuned correctly, the aircraft radio may have instability or frequency drift and is most likely unserviceable.

Diagnostics Mode Peak Power: This Power meter value indicates the peak power of the received signal. It is only meaningful if the Counter value is stable. When the Counter value is within +/-2 kHz of the "received" frequency value, the Peak Power value will typically be higher than the received Power value by 0 to 6 dB, depending on the percent modulation.

The higher the modulation, the larger the difference.

If the Counter value is within +/-10 kHz of the selected frequency, but no Frequency or Power values are displayed, this may be due to either a very weak or an extremely strong signal.

This will be indicated by the Peak Power value. Ideally, the Peak Power value should be between -20 and +24 dBm. If it is outside this range, in antenna connection mode, the received power (and Peak Power) can be adjusted by varying the distance between the aircraft antenna and the ARTS antenna.

1. In Antenna-mode, during RX, the "received" Power is also displayed. This is the power received by the ARTS (not what is transmitted by the aircraft radio) and is quite low due to the air-path losses.
2. During RX, if the "received" Power is either too low or too high, an indication of "Too Low" or "Too High" is displayed in red, below the Power-value box.
3. During RX, while the test is in progress, it is possible to change the selected frequency, without stopping the test.

SECTION 13: VHF COM FREQUENCY MODULATION (FM)

SUBSECTION 1: COM VHF FM OPERATION

WARNING

It is extremely dangerous to generate signals during testing that are on the frequencies that are in use by local ATC. When operating the Test Set in COM Mode please be aware of the local COM ATC frequencies. It is the test set operator's responsibility to make sure all testing is carried out on Frequencies that will not interfere with local navigation aids or ATC resources.

Please See Appendix A for technical specifications.

Test Hardware Required

Item	Test Type	Description / Notes	Part Number
Nav Com Antenna	Ant - Ant	Telescopic wide frequency band antenna.	123-0239
Antenna Tripod Adapter	Ant - Ant	Optional – Only required for remote ARTS 7000 to antenna connection.	116-0349
Tripod	Ant - Ant	Optional – Only required for remote ARTS 7000 to antenna connection.	118-2286
Coax Cable option of 6, 20 or 60 ft	Ant – Ant Direct Cable	Ant - Ant Optional – Only required for remote ARTS 7000 to antenna connection. Dir - Cbl – operator choice of length recommended to use shortest possible.	VARIOUS

COM VHF FM Test Selection

1. From the Main Menu select **Test Functions**.
2. From the Functions Menu select **COM**.
3. From the COM menu select **FM**.
4. The FM test Screen is now displayed.

COM FM Test Configuration

Before running the test, operators can use the default mode by pressing the **Default** button or accessing the config page via the **Config** button to establish the user preferences.

The ARTS 7000 stores the last configuration used and has a default setting. When the **Default** button on the test screen is pressed the ARTS 7000 automatically sets the default mode and settings.

Please See Appendix C for Default and Preset settings.

COM FM Test Configuration Screen

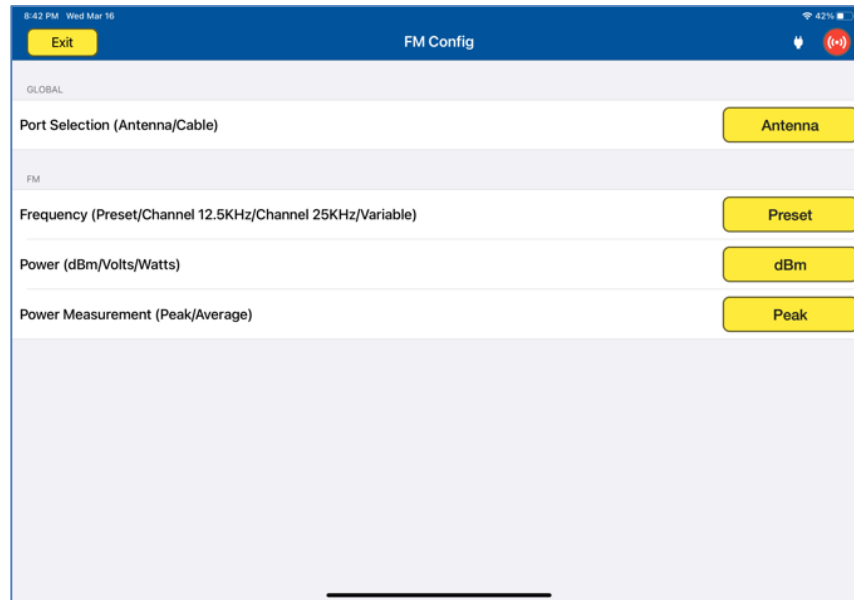

COM FM Test Configuration Controls and Selections

Item	Description
Port Selection (Cable/Antenna)	Selects the over the air (Antenna) connection Port or the Direct (Cable) Connection Port.
Frequency (Preset/Channel/Variable)	Allows the selection of the test COM FM Frequency. Selections are Preset (Laversab defined), Channel (Standard COM FM frequencies) or Variable.
Power (dBm/Volts/Watts)	Allows the selection of the test power units for the COM FM Signal. Selections are dBm, Volts, or Watts
Power Measurement (Peak/Average)	Selects methodology for power measurement during cable connected tests. Selections are Peak Power or Average Power.

COM FM Test Screens

Please note: the test screens differ between the main set up page, Transmit mode and Receive mode.

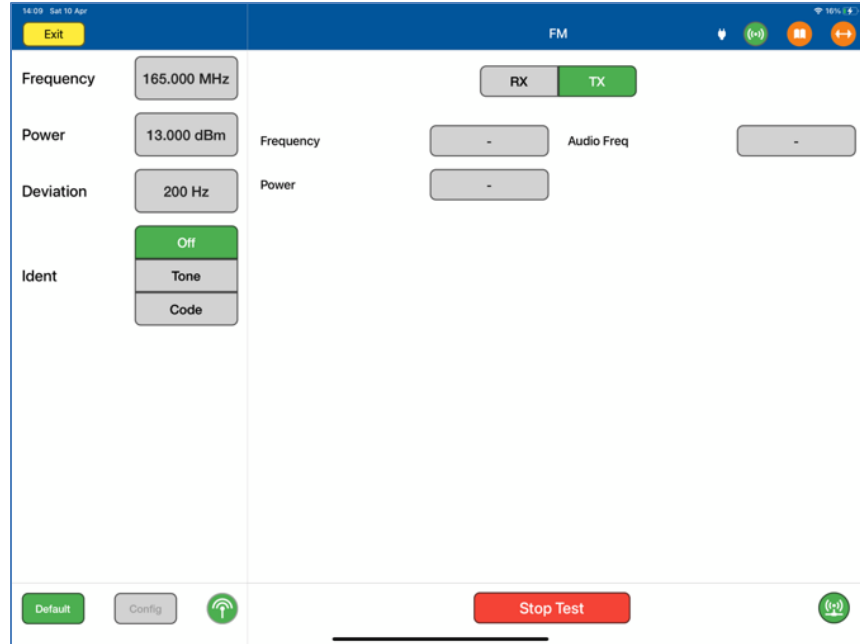

COM FM Main Test Screen And Screen during TX (Transmit)

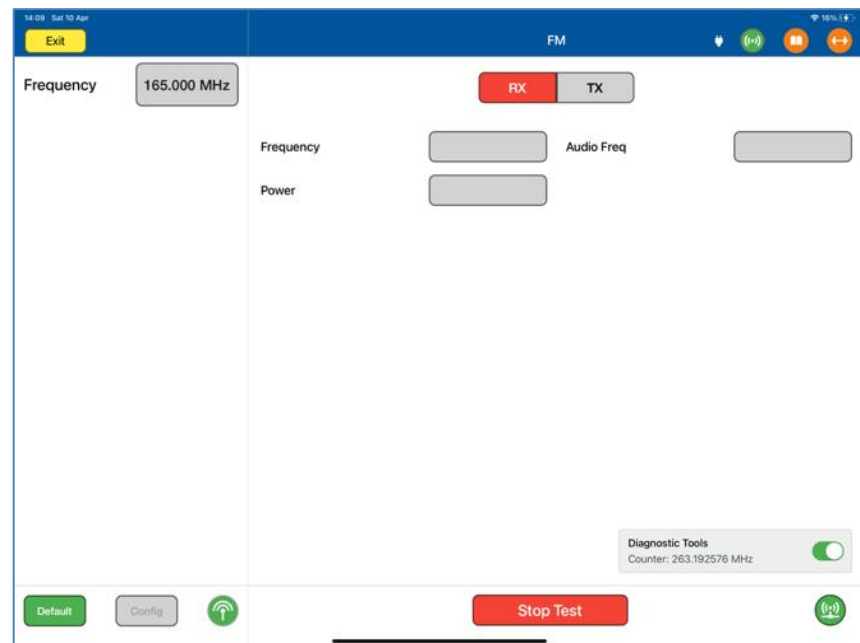

COM FM Test Screen in Receive Mode

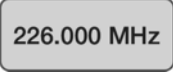
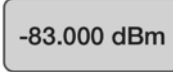
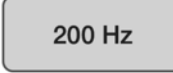
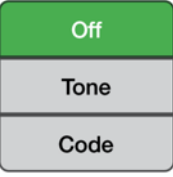

COM FM Test Controls and Selections

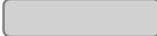
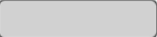
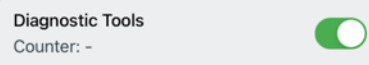
Item	Description
Frequency 	Sets Frequency of the ARTS 7000 Generated COM FM signal. <i>During an active test, fine adjustment is available. See below.</i>
Power 	Sets the output power of the ARTS 7000 generated COM FM signal. <i>Not shown in Rx mode.</i> <i>During an active test, fine adjustment is available. See below.</i>
Deviation 	Sets the Frequency Deviation of the COM FM signal. <i>Not shown in Rx mode.</i>
Ident 	Selects the Audio Identification transmission from the ARTS 7000. <i>Not shown in Rx mode.</i> Options are: Off , Tone (1KHz steady tone) or Code (Morse - LSB). When Code is selected the repetition rate is set at 30 seconds. The user can trigger an immediate Code transmission by pressing the Code button. Whenever the Code button is pushed the ARTS will immediately transmit the Code signal.
	Toggles the ARTS 7000 from Receive to Transmit mode. On Start up the ARTS 7000 is always in Receive mode. Press this button for Transmit or Receive.
Frequency 	During an active test this field will indicate the Transmitted Frequency from the Aircraft.
Audio Freq 	During an active test this field will indicate the approximate transmitted Audio Frequency from the Aircraft.
	Diagnostic tools for Frequency and Power checks. Only Active in RX mode See below for details.

SUBSECTION 2: COM FM TEST CONTROL DETAILS

1. **Frequency:** Sets the frequency of the ARTS 7000 generated COM FM frequency.
 - a. Note: when the test is running the Frequency can be course and fine-tuned to allow selectivity testing. This done by pushing the Frequency numerical field:

110.100 MHz

A pop-up is then displayed to allow live course and fine adjustment of the Transmitted Frequency.

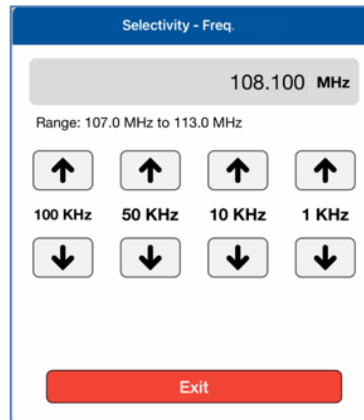

Frequency Selectivity pop-up for Selectivity testing.

2. **Power:** Sets the power of the ARTS 7000 generated COM FM signal.
 - a. Note: when the test is running the Power can be course and fine-tuned to allow sensitivity testing. This done by pushing the Power numerical field:

0.00 dBm

A pop-up is then displayed to allow live course and fine adjustment of the Transmitted Power.

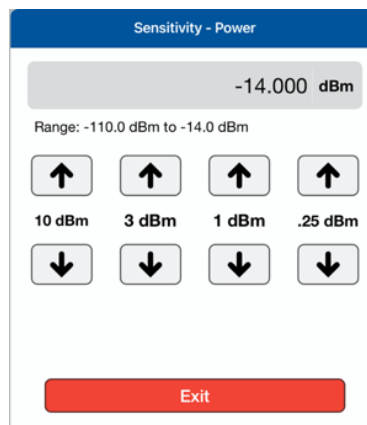

Pop-up for Sensitivity testing.

3. **Deviation:** Allows adjustment of the frequency deviation of the of the COM FM signal.
4. **Ident:** Allows the use to select the audio identifier of the ARTS 7000 generated FM signal. Possible Selections are:

4. **Off** – No Audio Ident
 5. **Code** – the ARTS 7000 generates a repetitive Morse code identification signal comprising the letters LSB. This LSB morse signal is sent every 30 seconds. The morse can be instantly transmitted manually by pressing the **Code** button.
 6. **Tone** – the ARTS 7000 generates a constant 1 kHz audio tone.
5. **Frequency** (indicator): Indication of the received frequency from the Aircraft transceiver. This field is only active when the ARTS 7000 is in receive mode and receives a signal from the aircraft when PTT is active.
 6. **Power** (indicator): Provides a power measurement indication of the signal received from the aircraft. This function is only active when the ARTS 7000 is in receive mode and receives a signal from the aircraft when PTT is active. Note: this function is only active when the ARTS 7000 is configured in a direct (Cable) connection to the aircraft transceiver.
 7. **Audio Freq** (indicator): This indicator gives the depth of modulation of the transmitted signal from the aircraft. This field is only active when the ARTS 7000 is in receive mode and receives a signal from the aircraft when PTT is active.

Diagnostic Tools.

Screen Shots of Diagnostic Tools Selection

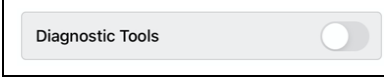
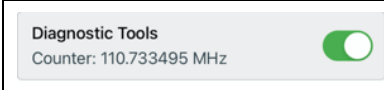
	Diagnostic Tools Off
	Diagnostic tools On Counter Display Shown.

The ARTS 7000 Test Application includes some diagnostic tools that can be used when the ARTS 7000 is in any COM VHF or HF receive mode. The Tools are only available when indicated in the bottom right corner of the test screen.

The only applicable tools will be displayed for the required test. Enabling these tools can help identify tuning errors, antenna issues, unstable transmitters, transmitters with drift, and verification checks for received frequencies and power. The Diagnostic Tools can be used at any time in RX, but they may be most helpful when the ARTS is unable to display “received” Frequency or Power values.

Diagnostics Mode Counter

The Counter measures the transmitted frequency from the Aircraft Radio. It may show a different value than the main test frequency. The counter has a wider band than the Main ARTS receiver.

1. If many frequencies are received the reading may fluctuate and not be useful.
2. If the received frequency is stable, this will be useful for comparison. If the Aircraft Radio is good the counter frequency and test page frequency should match.

3. If the counter frequency is more than +/-10KHz from the main test frequency, the main test frequency will not be displayed. Modulation and power values may be displayed, but they may not be correct. To fix this condition, verify that the aircraft radio is tuned correctly. If it is tuned correctly, the aircraft radio may have instability or frequency drift and is most likely unserviceable.

Diagnostics Mode Peak Power: This Power meter value indicates the peak power of the received signal. It is only meaningful if the Counter value is stable. When the Counter value is within +/-2 kHz of the “received” frequency value, the Peak Power value will typically be higher than the received Power value by 0 to 6 dB, depending on the percent modulation.

The higher the modulation, the larger the difference.

If the Counter value is within +/-10 kHz of the selected frequency, but no Frequency or Power values are displayed, this may be due to either a very weak or an extremely strong signal.

This will be indicated by the Peak Power value. Ideally, the Peak Power value should be between -20 and +24 dBm. If it is outside this range, in antenna connection mode, the received power (and Peak Power) can be adjusted by varying the distance between the aircraft antenna and the ARTS antenna.

1. In Antenna-mode, during RX, the “received” Power is also displayed. This is the power received by the ARTS (not what is transmitted by the aircraft radio) and is quite low due to the air-path losses.
2. During RX, if the “received” Power is either too low or too high, an indication of “Too Low” or “Too High” is displayed in red, below the Power-value box.
3. During RX, while the test is in progress, it is possible to change the selected frequency, without stopping the test.

SECTION 14: COM HIGH FREQUENCY (HF) SINGLE SIDE BAND (SSB)

SUBSECTION 1: COM SSB HF OPERATION

WARNING

It is extremely dangerous to generate signals during testing that are on the frequencies that are in use by local ATC. When operating the Test Set in COM Mode please be aware of the local COM ATC frequencies. It is the test set operator's responsibility to make sure all testing is carried out on Frequencies that will not interfere with local navigation aids or ATC resources.

Please See Appendix A for technical specifications.

Test Hardware Required

Item	Test Type	Description / Notes	Part Number
Nav Com Antenna	Ant - Ant	Telescopic wide frequency band antenna.	123-0239
Antenna Tripod Adapter	Ant - Ant	Optional – Only required for remote ARTS 7000 to antenna connection.	116-0349
Tripod	Ant - Ant	Optional – Only required for remote ARTS 7000 to antenna connection.	118-2286
Coax Cable option of 6, 20 or 60 ft	Ant – Ant Direct Cable	Ant - Ant Optional – Only required for remote ARTS 7000 to antenna connection. Dir - Cbl – operator choice of length recommended to use shortest possible.	VARIOUS

COM SSB HF Test Selection

1. From the Main Menu select **Test Functions**.
2. From the Functions Menu select **COM**.
3. From the COM menu select **SSB**.
4. The SSB test Screen is now displayed.

COM SSB HF Test Configuration

Before running the test, operators can use the default mode by pressing the **Default** button or accessing the config page via the **Config** button to establish the user preferences.

The ARTS 7000 stores the last configuration used and has a default setting. When the **Default** button on the test screen is pressed the ARTS 7000 automatically sets the default mode and settings.

Please See Appendix C for Default and Preset settings.

COM SSB HF Test Configuration Screen

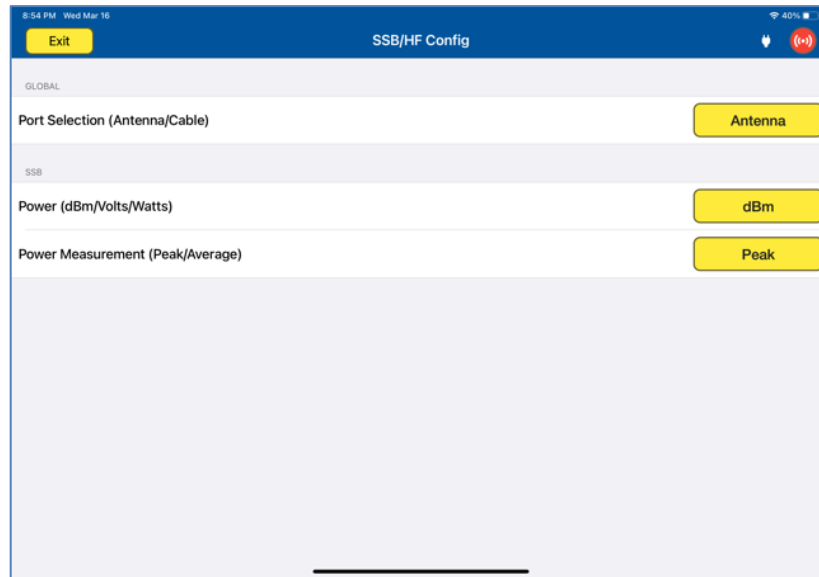

COM SSB HF Test Configuration Controls and Selections

Item	Description
Port Selection (Cable/Antenna)	Selects the over the air (Antenna) connection Port or the Direct (Cable) Connection Port.
Power (dBm/Volts/Watts)	Allows the selection of the test power units for the COM SSB HF Signal. Selections are dBm, Volts, or Watts
Power Measurement (Peak/Average)	Selects methodology for power measurement during cable connected tests. Selections are Peak Power or Average Power.

COM SSB HF Test Screen

Please note: the test screens differ between the main set up page, transmit mode and Receive mode.



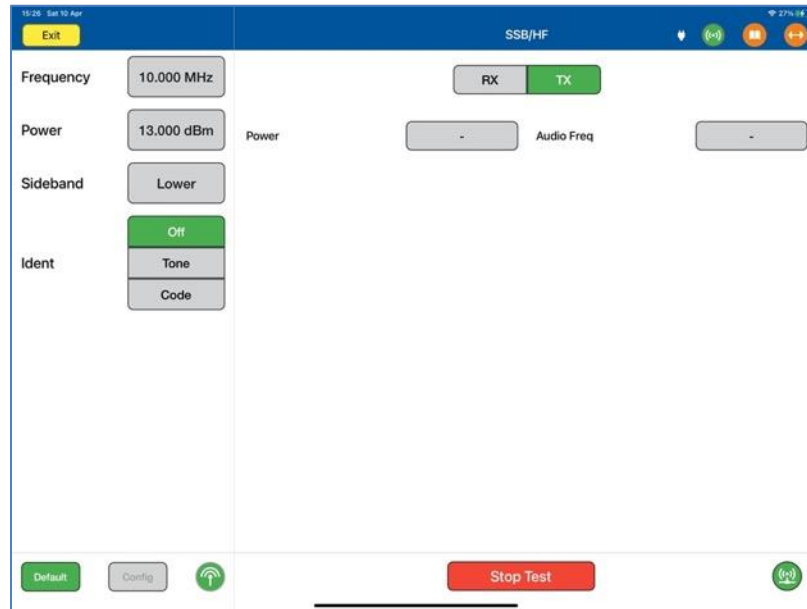

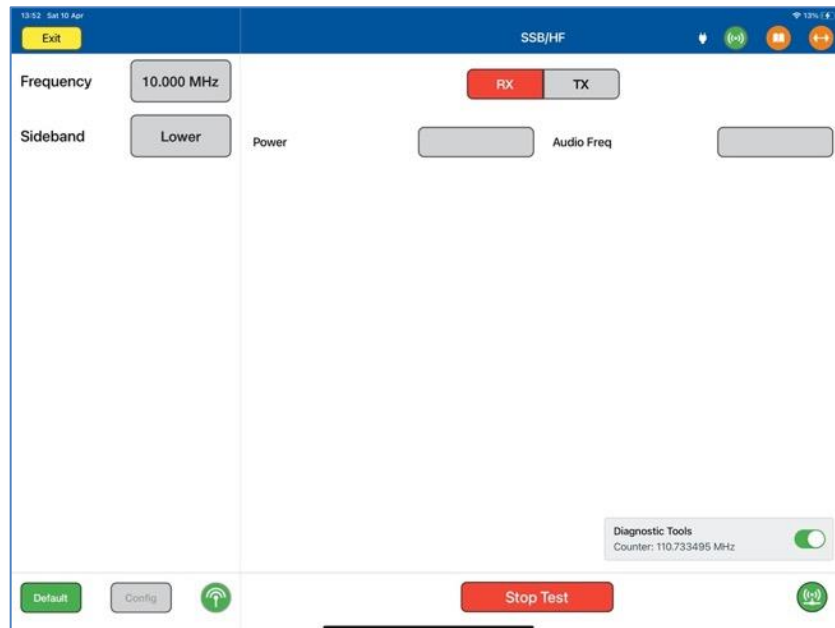

Com SSB HF Main Test Screen and Screen during TX (Transmit)



Com SSB/HF Test Screen in RX (Receive)

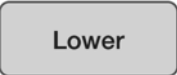
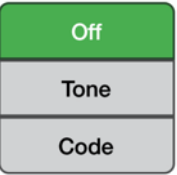

COM HF Test Controls and Selections

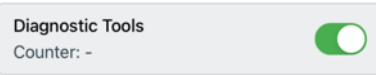
Item	Description
Frequency 	Sets Frequency of the ARTS 7000 Generated COM SSB HF signal. <i>During an active test, fine adjustment is available. See below.</i>
Power 	Sets the output power of the ARTS 7000 generated COM SSB HF signal. <i>Not shown in Rx mode.</i> <i>During an active test, fine adjustment is available. See below.</i>
Sideband 	Sets which Side band of the SSB HF signal to use – Upper or Lower. <i>During an active test, fine adjustment is available. See below.</i>
Ident 	Selects the Audio Identification transmission from the ARTS 7000. <i>Not shown in Rx mode.</i> Options are: Off , Tone (1KHz steady tone) or Code (Morse - LSB). When Code is selected the repetition rate is set at 30 seconds. The user can trigger an immediate Code transmission by pressing the Code button. Whenever the Code button is pushed the ARTS will immediately transmit the Code signal.
	Toggles the ARTS 7000 from Receive to Transmit mode. On Start up the ARTS 7000 is always in Receive mode. Press this button for Transmit or Receive.
Power 	During an active test this field will indicate the Transmitted Frequency from the Aircraft. <i>Note – this feature is only active when in a direct cable connection mode only.</i>
Audio Freq 	During an active test this field will indicate the approximate transmitted Audio Frequency from the Aircraft.
	Diagnostic tools for Frequency and Power checks. Only Active in RX mode See below for details.

Subsection 2: COM HF Test Control Details

1. **Frequency:** Sets the frequency of the ARTS 7000 generated COM HF frequency.
 - a. Note: when the test is running the Frequency can be course and fine-tuned to allow selectivity testing. This done by pushing the Frequency numerical field:

110.100 MHz

A pop-up is then displayed to allow live course and fine adjustment of the Transmitted Frequency.

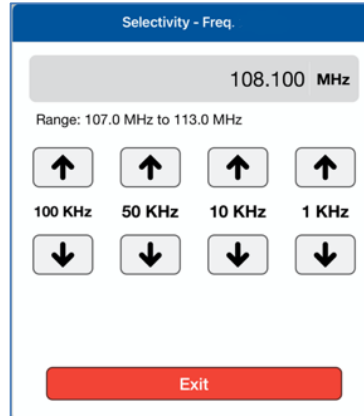

Frequency Selectivity pop-up for Selectivity testing.

2. **Power:** Sets the power of the ARTS 7000 generated COM HF signal.
 - a. Note: when the test is running the Power can be course and fine-tuned to allow sensitivity testing. This done by pushing the Power numerical field:

0.00 dBm

A pop-up is then displayed to allow live course and fine adjustment of the Transmitted Power.

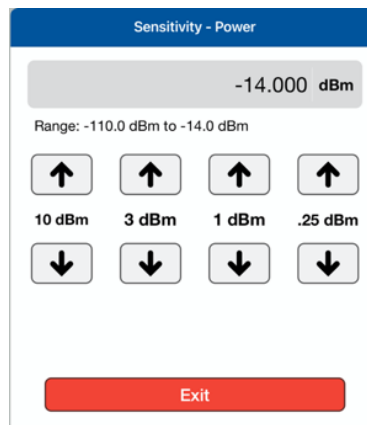

Pop-up for Sensitivity testing.

3. **Sideband:** Allows selection of the upper or lower sideband COM HF signal.
4. **Ident:** Allows the use to select the audio identifier of the ARTS 7000 generated HF signal. Possible Selections are:

1. **Off** – No Audio Ident
 2. **Code** – the ARTS 7000 generates a repetitive Morse code identification signal comprising the letters LSB. This LSB morse signal is sent every 30 seconds. The morse can be instantly transmitted manually by pressing the **Code** button.
 3. **Tone** – the ARTS 7000 generates a constant 1 kHz audio tone.
5. **Frequency** (indicator): Indication of the received frequency from the Aircraft transceiver. This field is only active when the ARTS 7000 is in receive mode and receives a signal from the aircraft when PTT is active.
 6. **Power** (indicator): Provides a power measurement indication of the signal received from the aircraft. This function is only active when the ARTS 7000 is in receive mode and receives a signal from the aircraft when PTT is active. Note: this function is only active when the ARTS 7000 is configured in a direct (Cable) connection to the aircraft transceiver.
 7. **Audio Freq** (indicator): This indicator gives the depth of modulation of the transmitted signal from the aircraft. This field is only active when the ARTS 7000 is in receive mode and receives a signal from the aircraft when PTT is active.

Diagnostic Tools

Screen Shots of Diagnostic Tools Selection

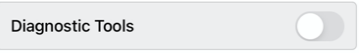
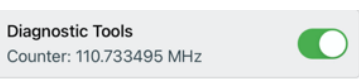
	Diagnostic Tools Off
	Diagnostic tools On Counter Display Shown.

The ARTS 7000 Test Application includes some diagnostic tools that can be used when the ARTS 7000 is in any COM VHF or HF receive mode. The Tools are only available when indicated in the bottom right corner of the test screen.

The only applicable tools will be displayed for the required test. Enabling these tools can help identify tuning errors, antenna issues, unstable transmitters, transmitters with drift, and verification checks for received frequencies and power. The Diagnostic Tools can be used at any time in RX, but they may be most helpful when the ARTS is unable to display “received” Frequency or Power values.

Diagnostics Mode Counter

The Counter measures the transmitted frequency from the Aircraft Radio. It may show a different value than the main test frequency. The counter has a wider band than the Main ARTS receiver.

1. If many frequencies are received the reading may fluctuate and not be useful.
2. If the received frequency is stable, this will be useful for comparison. If the Aircraft Radio is good the counter frequency and test page frequency should match.
3. If the counter frequency is more than +/-10KHz from the main test frequency, the main test frequency will not be displayed. Modulation and power values may be displayed, but

they may not be correct. To fix this condition, verify that the aircraft radio is tuned correctly. If it is tuned correctly, the aircraft radio may have instability or frequency drift and is most likely unserviceable.

Diagnostics Mode Peak Power: This Power meter value indicates the peak power of the received signal. It is only meaningful if the Counter value is stable. When the Counter value is within +/-2 kHz of the “received” frequency value, the Peak Power value will typically be higher than the received Power value by 0 to 6 dB, depending on the percent modulation.

The higher the modulation, the larger the difference.

If the Counter value is within +/-10 kHz of the selected frequency, but no Frequency or Power values are displayed, this may be due to either a very weak or an extremely strong signal.

This will be indicated by the Peak Power value. Ideally, the Peak Power value should be between -20 and +24 dBm. If it is outside this range, in antenna connection mode, the received power (and Peak Power) can be adjusted by varying the distance between the aircraft antenna and the ARTS antenna.

1. In Antenna-mode, during RX, the “received” Power is also displayed. This is the power received by the ARTS (not what is transmitted by the aircraft radio) and is quite low due to the air-path losses.
2. During RX, if the “received” Power is either too low or too high, an indication of “Too Low” or “Too High” is displayed in red, below the Power-value box.
3. During RX, while the test is in progress, it is possible to change the selected frequency, without stopping the test.

SECTION 15: COM SELCAL

SUBSECTION 1: COM SELCAL OPERATION

WARNING

It is extremely dangerous to generate signals during testing that are on the frequencies that are in use by local ATC. When operating the Test Set in COM Mode please be aware of the local COM ATC frequencies. It is the test set operator's responsibility to make sure all testing is carried out on Frequencies that will not interfere with local navigation aids or ATC resources.

Please See Appendix A for technical specifications.

Test Hardware Required

Item	Test Type	Description / Notes	Part Number
Nav Com Antenna	Ant - Ant	Telescopic wide frequency band antenna.	123-0239
Antenna Tripod Adapter	Ant - Ant	Optional – Only required for remote ARTS 7000 to antenna connection.	116-0349
Tripod	Ant - Ant	Optional – Only required for remote ARTS 7000 to antenna connection.	118-2286
Coax Cable option of 6, 20 or 60 ft	Ant – Ant Direct Cable	Ant - Ant Optional – Only required for remote ARTS 7000 to antenna connection. Dir - Cbl – operator choice of length recommended to use shortest possible.	VARIOUS

COM SelCal Test Selection

1. From the Main Menu select **Test Functions**.
2. From the Functions Menu select **COM**.
3. From the COM menu select **SelCal**.
4. The SelCal test Screen is now displayed.

COM SelCal Test Configuration

Before running the test, operators can use the default mode by pressing the **Default** button or accessing the config page via the **Config** button to establish the user preferences.

The ARTS 7000 stores the last configuration used and has a default setting. When the **Default** button on the test screen is pressed the ARTS 7000 automatically sets the default mode and settings.

Please See Appendix C for Default and Preset settings.

COM SelCal Test Configuration Screen

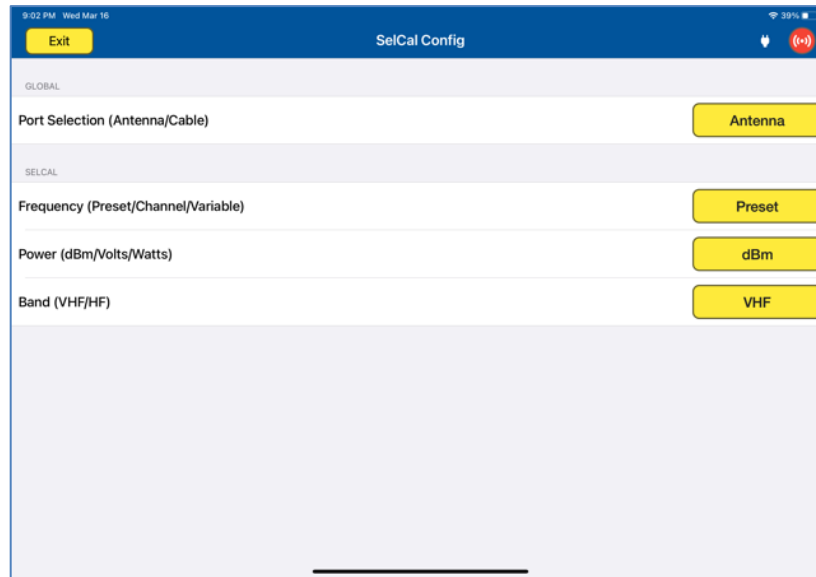

COM SelCal Test Configuration Controls and Selections

Item	Description
Port Selection (Cable/Antenna)	Selects the over the air (Antenna) connection Port or the Direct (Cable) Connection Port.
Frequency (Preset/Channel/Variable)	Allows the selection of the test Frequency. Selections are Preset (Laversab defined), Channel (Standard COM FM frequencies) or Variable.
Power (dBm/Volts/Watts)	Allows the selection of the test power units for the COM SSB HF Signal. Selections are dBm, Volts, or Watts
Band	Selects the communication band for the SelCal tests. Selections are VHF or HF

COM SelCal Test Screen

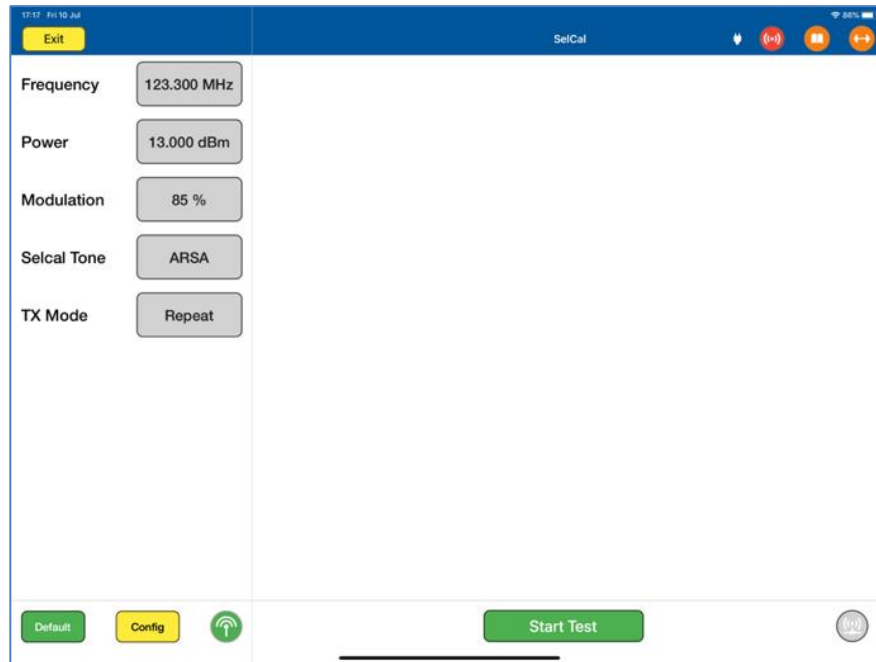

Item	Description
Frequency <input type="text" value="10.000 MHz"/>	Sets Frequency of the ARTS 7000 generated COM SelCal Test signal. During an active test, fine adjustment is available. See below.
Power <input type="text" value="-83.000 dBm"/>	Sets the output power of the ARTS 7000 generated COM SelCal signal. During an active test, fine adjustment is available. See below.
Modulation <input type="text" value="85 %"/>	Sets the % level of modulation of the ARTS 7000 generated COM SelCal signal.
Selcal Tone <input type="text" value="ARSA"/>	Select the 4-digit SelCal code to match the test aircraft.
TX Mode <input type="text" value="Repeat"/>	TX Mode can be set to either Single or Repeat before or during test. Single mode: a single transmission is made Repeat mode: the transmission is cycled continuously

SUBSECTION 2: COM SELCAL TEST CONTROL DETAILS

SelCal Test Controls and Selections

1. **Frequency:** Sets the frequency of the ARTS 7000 generated COM SelCal frequency.
 - a. Note: when the test is running the Frequency can be course and fine-tuned to allow selectivity testing. This done by pushing the Frequency numerical field:

110.100 MHz

A pop-up is then displayed to allow live course and fine adjustment of the Transmitted Frequency.

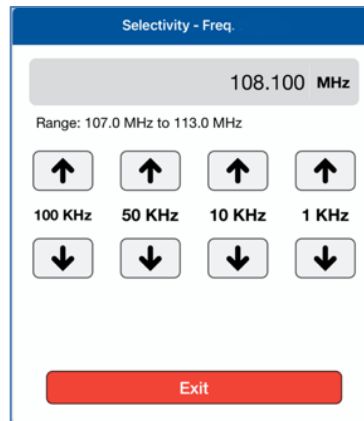

Frequency Selectivity pop-up for Selectivity testing.

2. **Power:** Sets the power of the ARTS 7000 generated COM SelCal signal.
 - a. Note: when the test is running the Power can be course and fine-tuned to allow sensitivity testing. This done by pushing the Power numerical field:

0.00 dBm

A pop-up is then displayed to allow live course and fine adjustment of the Transmitted Power.

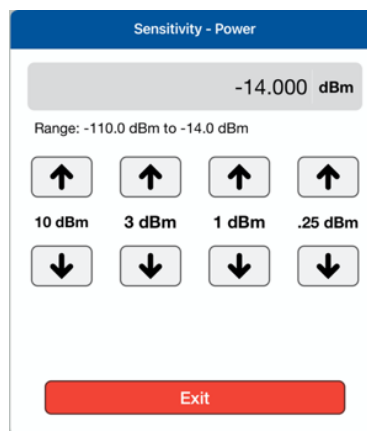

Pop-up for Sensitivity testing.

3. **Modulation:** Sets the modulation level of the ARTS 7000 generated COM SelCal signal.

4. **SelCal Tone:** Sets the 4-digit SelCal code to match the test aircraft.
5. **TX Mode:** The SelCal test signal can be used in a single or repeat mode (Repeat mode is recommended). The Single Mode allows a single transmission to the aircraft under test. In Repeat Mode the transmission is cycled continuously in an Off-On-Off sequence.

SECTION 16: ELT EMERGENCY LOCATION TRANSMITTERS

SUBSECTION 1: ELT OPERATION

WARNING

It is extremely dangerous to generate ELT signals during testing. When operating the Test Set in ELT Mode please be aware of the local rules regarding transmission of ELT signals. Please be aware that large fines may be charged for unsafe testing of aircraft ELT. It is the test set operator's responsibility to make sure all testing is carried out to the current local rulings and requirements.

Please See Appendix A for technical specifications.

Test Hardware Required

Item	Test Type	Description / Notes	Part Number
Nav Com Antenna	Ant - Ant	Telescopic wide frequency band antenna.	123-0239
Antenna Tripod Adapter	Ant - Ant	Optional – Only required for remote ARTS 7000 to antenna connection.	116-0349
Tripod	Ant - Ant	Optional – Only required for remote ARTS 7000 to antenna connection.	118-2286
Coax Cable option of 6, 20 or 60 ft	Ant – Ant Direct Cable	Ant - Ant Optional – Only required for remote ARTS 7000 to antenna connection. Dir - Cbl – operator choice of length recommended to use shortest possible.	VARIOUS

ELT Test Selection

1. From the Main Menu select **Test Functions**.
2. From the Functions Menu select **ELT**.
3. The ELT test Screen is now displayed.

ELT Test Configuration

Before running the test, operators can use the default mode by pressing the **Default** button or accessing the config page via the **Config** button to establish the user preferences.

The ARTS 7000 stores the last configuration used and has a default setting. When the **Default** button on the test screen is pressed the ARTS 7000 automatically sets the default mode and settings.

Please See Appendix C for Default and Preset settings.

ELT Test Configuration Screen

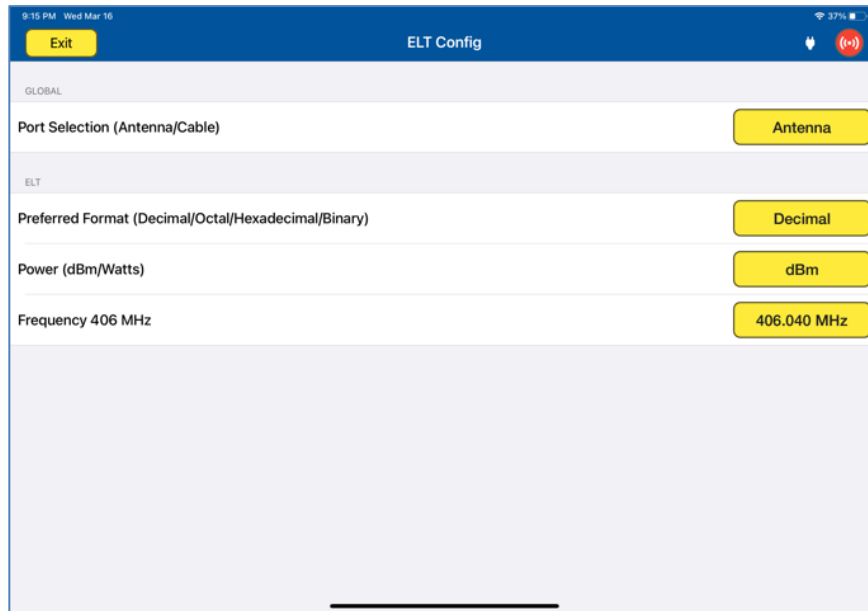

ELT Test Configuration Controls and Selections

Item	Description
Port Selection (Cable/Antenna)	Selects the over the air (Antenna) connection Port or the Direct (Cable) Connection Port.
Power (dBm/Watts)	Selects the power values units
Preference (Decimal/Octal/Hexadecimal/Binary)	Allows selection of the data format for 406 MHz ELT
Frequency 406 MHz	Allows the selection of the default 406 MHz frequency. Different manufacturers of ELT use different transmission frequencies.

SUBSECTION 2: ELT TEST SCREENS AND TEST PROCEDURE

1. From the Config menu select Antennae or Cable connection.
 - 1.1.1. For Antenna Connection – connect the telescoping antenna to the antenna port of the Nav Com Module (BNC). Position the antenna as close as possible to the ELT antenna. If necessary, use the tripod and cable to achieve the best location.
 - 1.1.2. For Cable connection – connect the ELT output port to the Cable (Direct) connection on the ARTS Nav com module (TNC).
- 1.2. Connect the ARTS to the iPad using the standard method. Once the connection is made select **ELT** from the ARTS 7000 **Test Functions** page.
- 1.3. In the ELT test, the following screen is presented.

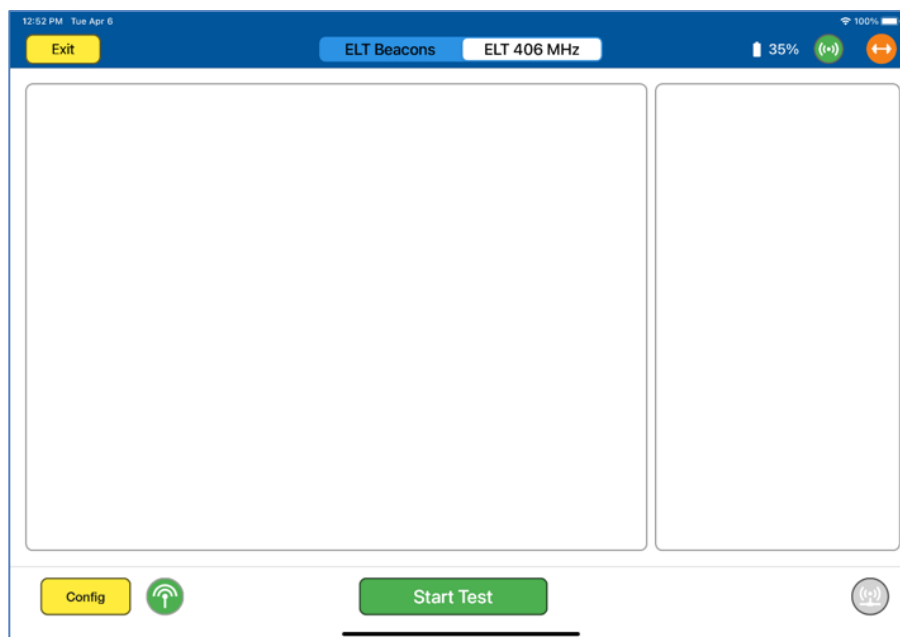

- 1.4. Select which type of ELT test is to be completed, using the menu bar in the top bar of the test screen. 

Selections are – **ELT Beacons** or **ELT 406 MHz**. Default test is ELT 406 MHz.

ELT Beacons: tests the 121.5 MHz and 243MHz transmissions of the ELT under test. See Section 4.

ELT 406 MHz: tests the 406 MHz transmissions of the ELT under test. See Section 2 & 3.

- 1.5. The test procedure is managed on the test screen by the prompts in the right-hand box. It is essential that the operator follows the prompts exactly as they are written. It is vital to not push **Confirm** until each step of the prompts has been completed.

2. The following Section details the ELT 406 MHz Test Procedure.

2.1. Testing ELT 406 is completed in 2 steps.

First, the test is completed with the ELT in Test-Mode. Test-Mode uses the ELTs built in test transmission. This is done using the test switch on the ELT.

If necessary, the second level, live transmission procedure can be completed. In this case the test is completed in ON-Mode. On-Mode is a live transmission from the ELT. This test can be dangerous and should only be completed during the local allocated time period. Violations of this protocol could result in severe penalties. note the specific timings identified in the test procedure below.

WARNING

It is extremely dangerous to generate ELT signals during testing. When operating the Test Set in ELT Mode please be aware of the local rules regarding transmission of ELT signals. Please be aware that large fines may be charged for unsafe testing of aircraft ELT. It is the test set operator's responsibility to make sure all testing is carried out to the current local rulings and requirements.

2.2. GPS Data.

2.2.1. Test-Mode. When the ELT is tested in Test-Mode the resulting GPS positional information (Lat and Lon) may be the correct position if valid GPS information is available. However, if there is no GPS data available the result may be blank, indicate last know position or indicate a default value of LAT 127 degrees and LON 255 degrees.

2.2.2. ON-Mode. During the On-Mode test the resulting GPS information (Lat and Lon) may be the correct position if valid GPS information is available. However, if there is no GPS data available the result may be blank, indicate last know position or indicate a default value of LAT 127 degrees and LON 255 degrees.

2.3. When the ELT 406 MHz test is selected the following test page will be displayed.

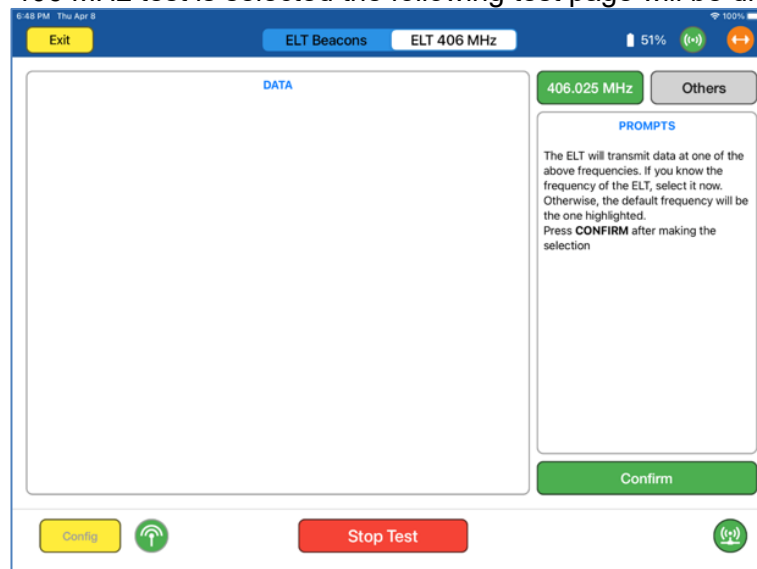

- 2.4. From this test screen, please follow the prompts in the right-hand box using the **Confirm** button to activate your selections.
- 2.5. Using the Frequency Selection buttons at the top right of the screen, either select the default frequency of **406.025 MHz** or if the specific ELT frequency is known, enter the ELT specific transmission frequency through the **Others** Selection. Once a selection has been made press **Confirm**.
- 2.6. Depending on the timing of the selection of frequency and/or if this is the first ELT test run, the ARTS 7000 may enter a 45 Second set up procedure. A count down timer will be shown if this set up procedure is running. The ARTS will then transfer to the next screen.
- 2.7. ELT 406 MHz Test screen using ELT Test Mode.

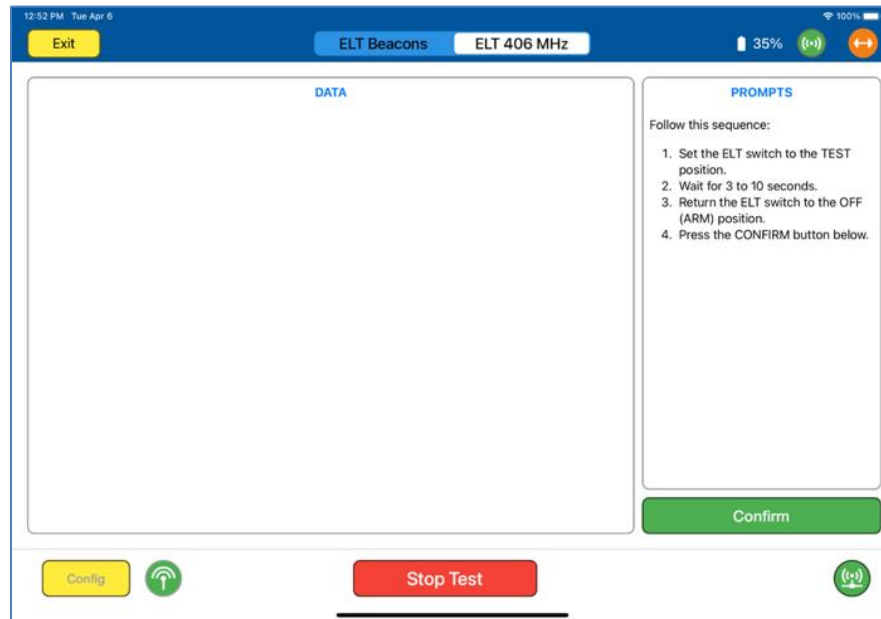

- 2.8. Result Screens Definitions and Indicators - Please note the results indicators in the right-hand box. The definitions and conditions for these indicators are defined below :

2.8.1. **DATA:**

- Not received** : No discernable data information was received.
Received : Valid data has been received and decoded. Data will be displayed in the left side of the screen
Corrupt Message : Some data has been received but it cannot be decoded.

2.8.2. **POWER:**

- ??** : No discernable Power was measured.

XX.XXdBm : A transmission with good power level has been successfully received and is displayed XX.XX are numeric values for the power attribute.

XX.XXdBm Too Low : A transmission with measurable power has been received but the level received is too low.

2.8.3. FREQUENCY:

?? : No discernable frequency has been received.

406.XXXMHz : A transmitted frequency has been received and identified. XXX are numerical values for the received frequency.

2.8.4. Results pages Control Buttons.

2.8.4.1. **Discard**: Discards the existing test result and performs another test.

2.8.4.2. **Re-Test**: Saves the existing test result data and performs another test.

2.8.4.3. **ON-Mode Test**: Saves the existing test result data and proceeds to check the ELT's in a live ON-Mode. In ON-Mode the ELT is transmitting as it would be when it is activated. Please be aware of the dangers in carrying out this mode. Please note when a ELT is tested in test mode i.e. not operational unless the GPS in the system has live data the ELT will default to LAT 127 degrees and LON 255 degrees.

2.9. Example of a good Test with ELT Data displayed correctly. Data is received, Power and Frequency are both good.

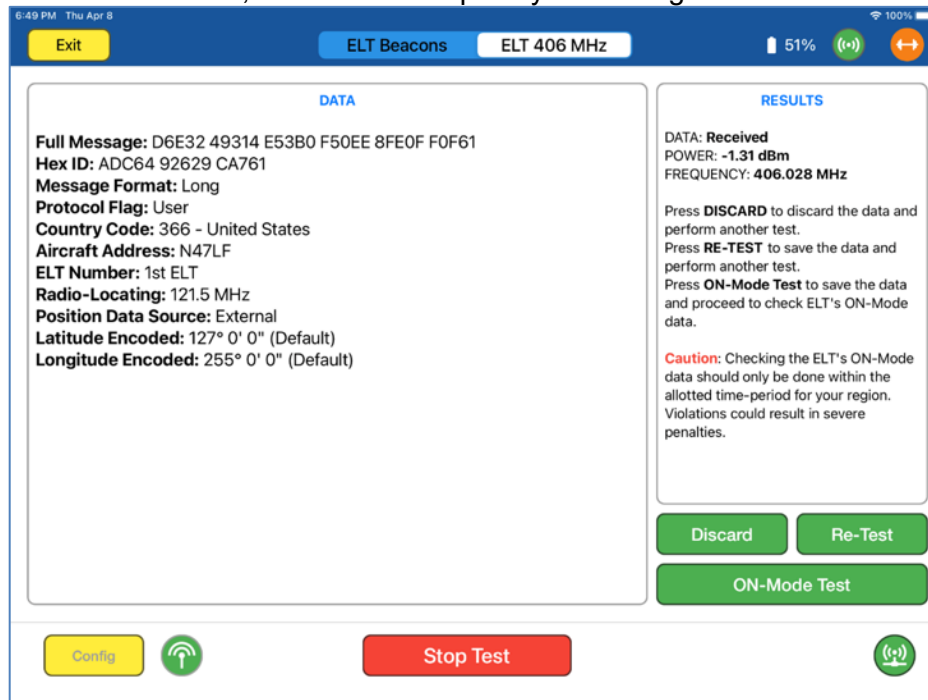

- 2.10. At this point of the test if failures are experienced. There are several possibilities that may be causing the failure these are:
- 2.10.1. No data (and no power) and no frequency. This would indicate that the antenna is not picking up any signal. Reducing the distance between antennas is the only way to rectify this. Naturally, if the ELT does not transmit anything, there is no chance of receiving anything.
 - 2.10.2. A frequency is displayed but it is not within +/-2 kHz of one of the four ELT frequencies. In this situation it may be best to STOP the test and restart from the beginning.
 - 2.10.3. A frequency is displayed which is within +/-2 kHz of one of the four ELT frequencies. This frequency will be used as the default for further testing and should not be changed. If the displayed frequency is different from the selected frequency, it is unlikely that any data will be received. If the displayed frequency is the same as the selected frequency, there is a good chance that data will be received. In either case, performing another test using the DISCARD or RE-TEST buttons, will most likely provide good results.
 - 2.10.4. Data is received but is corrupted. The RESULTS will show “DATA: **Corrupt message**”. A retest is required checking frequency selection and antenna position.
 - 2.10.5. Data is received but the Power is too low. The “Too Low” indication will be shown to the right of the power value.
 - 2.10.6. The GPS coordinates transmitted by the ELT in test mode are default values of 127 deg. (LAT) and 255 deg. (LONG). To get the correct GPS coordinates, the ELT must be operated in ON (operational) mode. See the next section on ELT live data and GPS verification.

3. Running ON-Mode Test Procedure

Once good test results are achieved using the Test-Mode process above (i.e. using the ELT test mode function). If necessary, the test can be continued further to verify live transmission data and in particular Live GPS positional data.

Note: GPS data will only be available if live GPS positional information is available to the ELT under test

This test should only be carried out with extreme caution.

WARNING

It is extremely dangerous to generate ELT signals during testing. When operating the Test Set in ELT Mode please be aware of the local rules regarding transmission of ELT signals. Please be aware that large fines may be charged for unsafe testing of aircraft ELT. It is the test set operator's responsibility to make sure all testing is carried out to the current local rulings and requirements.

- 3.1. From the Test-Mode results page select **ON-Mode Test**. The following test page is now shown.

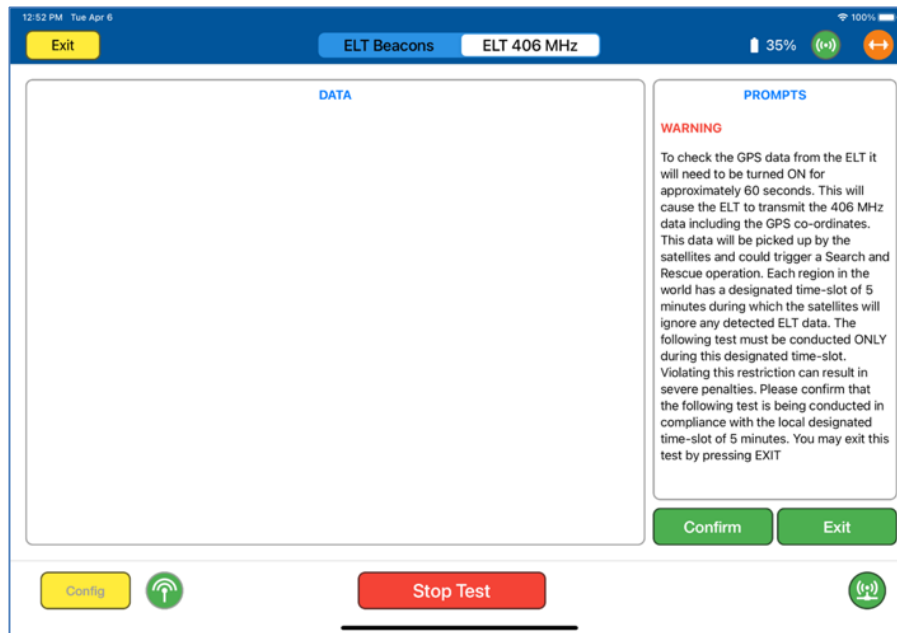

- 3.2. Press **Confirm** to continue the test the next page will be displayed. This is the main test page for the Live-Mode transmission. Please follow the prompts. Note: Once the ELT is switched on it is essential to press **Confirm** immediately. The test screen will then display a 60 second timer. When the 60 seconds is up the display will indicate to switch off the ELT. Please switch off the ELT promptly after the 60 seconds.

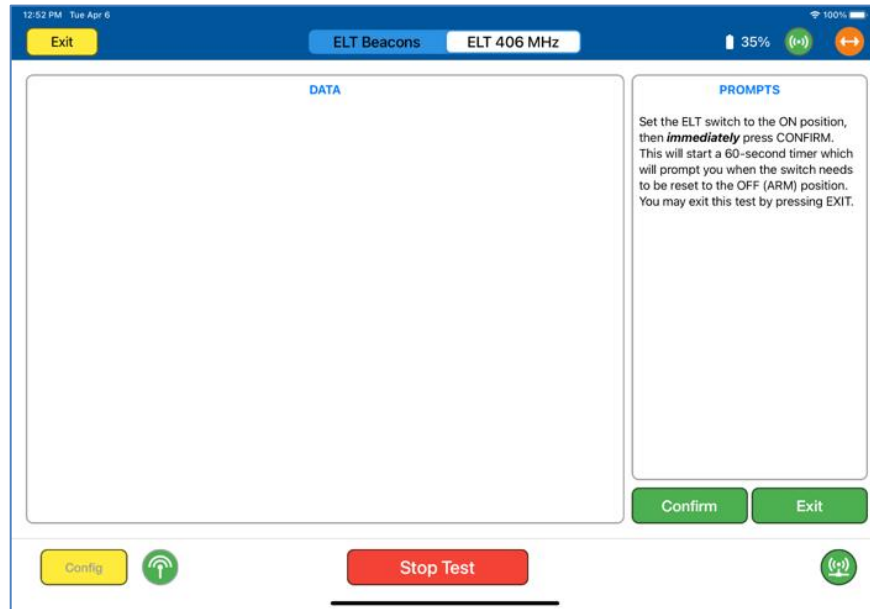

- 3.3. The following Screen is displayed once the 60 second timer is complete and therefore indicates that the ELT should be switched off. Press **Confirm** when the test is completed, and the ELT is off.

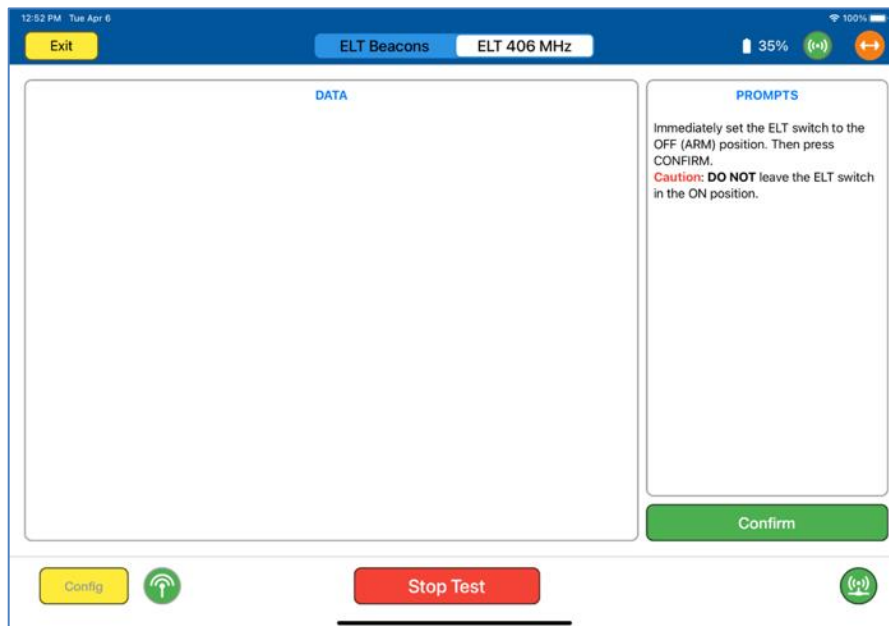

3.4. The Test results should be displayed.

Note: this example screen shows default GPS positional data.

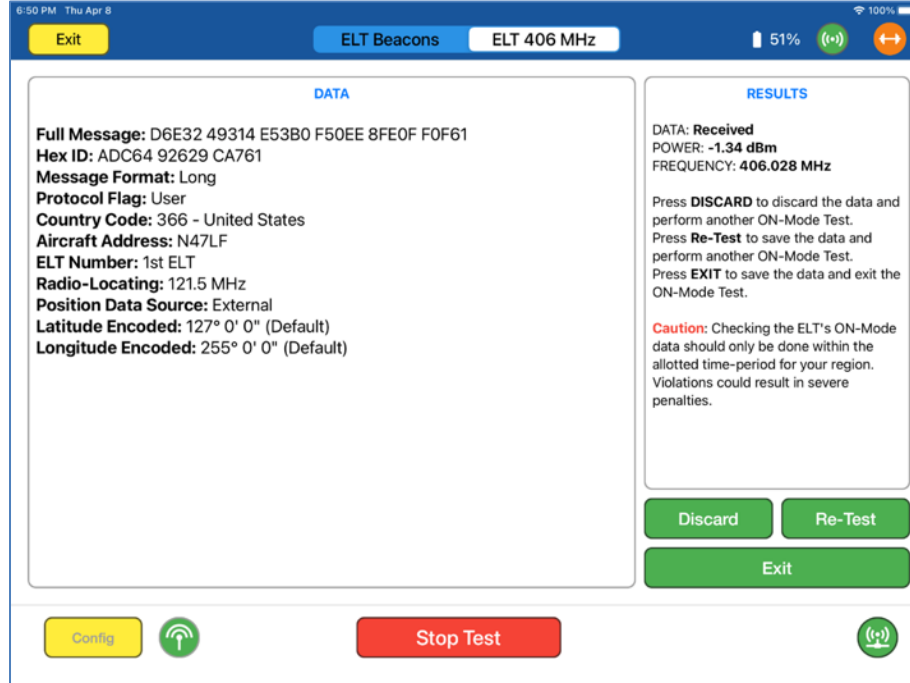

3.5. Result Screens Definitions and Indicators - Please note the results indicators in the right-hand box. The definitions and conditions for these indicators are defined below :

3.5.1. DATA:

- Not received** : No discernable data information was received.
- Received** : Valid data has been received and decoded. Data will be displayed in the left side of the screen
- Corrupt Message** : Some data has been received but it cannot be decoded.

3.5.2. POWER:

- ??** : No discernable Power was measured.
- XX.XXdBm** : A transmission with good power level has been successfully received and is displayed XX.XX are numeric values for the power attribute.
- XX.XXdBM Too Low** : A transmission with measurable power has been received but the level received is too low.

3.5.3. FREQUENCY:

- ??** : No discernable frequency has been received.
- 406.XXXMHz** : A transmitted frequency has been received and identified. XXX are numerical values for the received frequency.

3.5.4. Results pages Control Buttons.

- 3.5.4.1. **Discard:** Discards the existing test result and performs another test.
- 3.5.4.2. **Re-Test:** Saves the existing test result data and performs another test.
- 3.5.4.3. **Exit:** Saves the existing test result data and returns the test set to the start of the ON-Mode Test

3.6. GPS Data.

- 3.6.1. During the On-Mode test the resulting GPS information (Lat and Lon) may be the correct position if valid GPS information is available. However, if there is no GPS data available the result may be blank, indicate last know position or indicate a default value of LAT 127 degrees and LON 255 degrees.

3.7. Select **EXIT** to end the test and save the test results.

4. Testing ELT Beacons.

- 4.1. To select the beacon test from the main ELT Test page, select ELT Beacons from the top menu. The following screen is displayed.



4.2. Click **Start Test** – the following screen is displayed

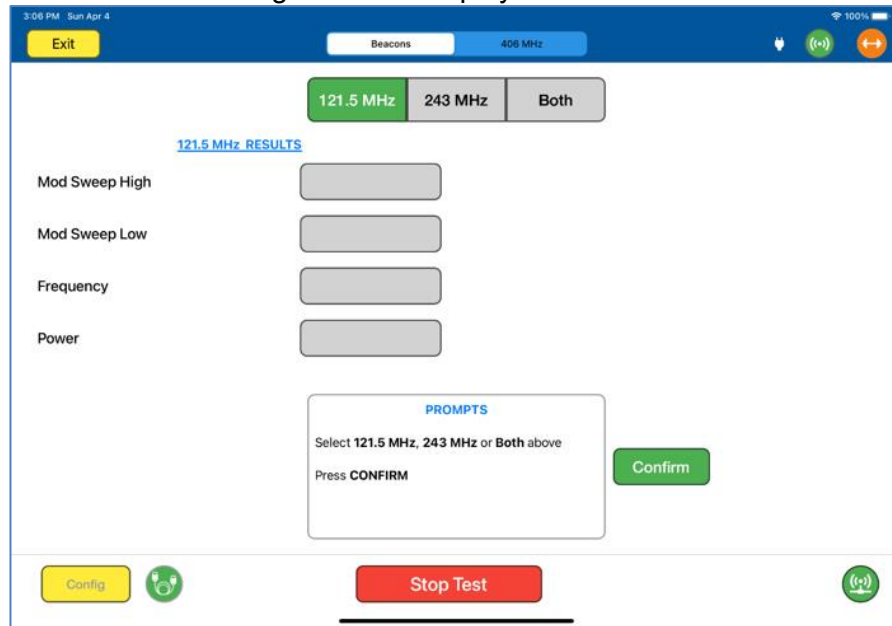

4.3. The User can now select **121.5MHz**, **243MHz** or **Both**. The ARTS defaults to 121.5 MHz

Note: the display of 121.5 MHz characteristics are displayed, Mod Sweep High, Mod Sweep Low Frequency and Power.

4.4. If 243MHz is selected the following Screen is displayed Note the display of 243 MHz characteristics are displayed, Mod Sweep High, Mod Sweep Low Frequency and Power

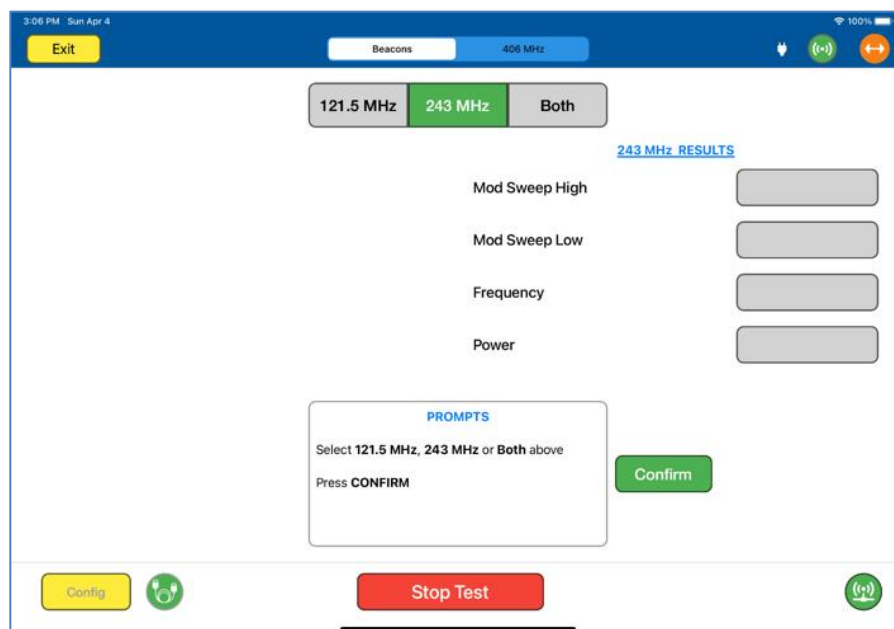

4.5. If **Both** is selected the following screen is displayed.

Note. The 121.5 MHz and 243MHz characteristics are both displayed: Mod Sweep High, Mod Sweep Low Frequency and Power

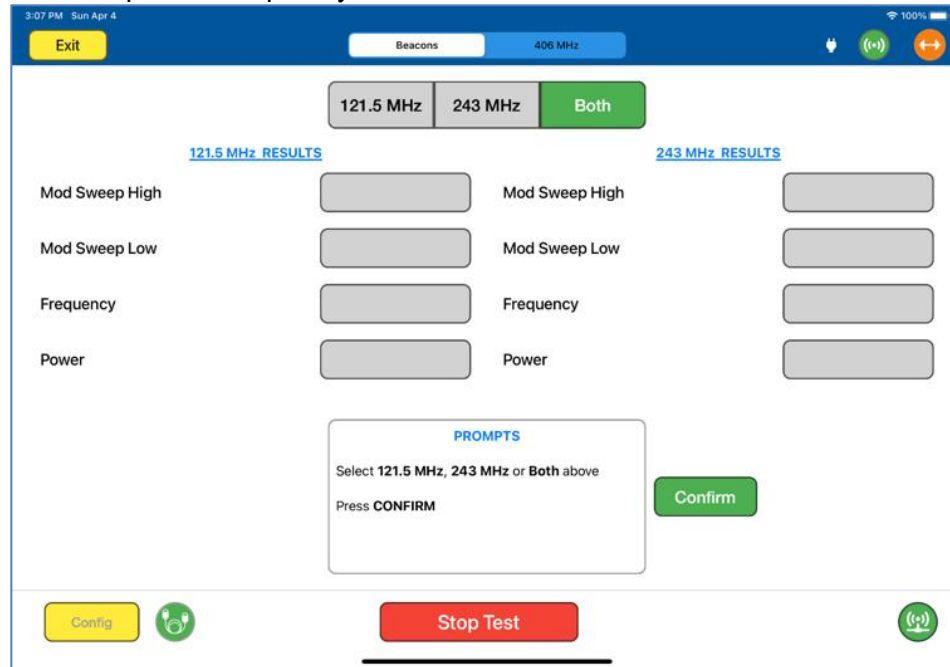

4.6. Once the selection of Beacons is made the **Confirm** button will move to the screen that asks the user to switch on the ELT. In this case the 121.5MHz beacon has been selected. The procedure for all beacon tests is the same.

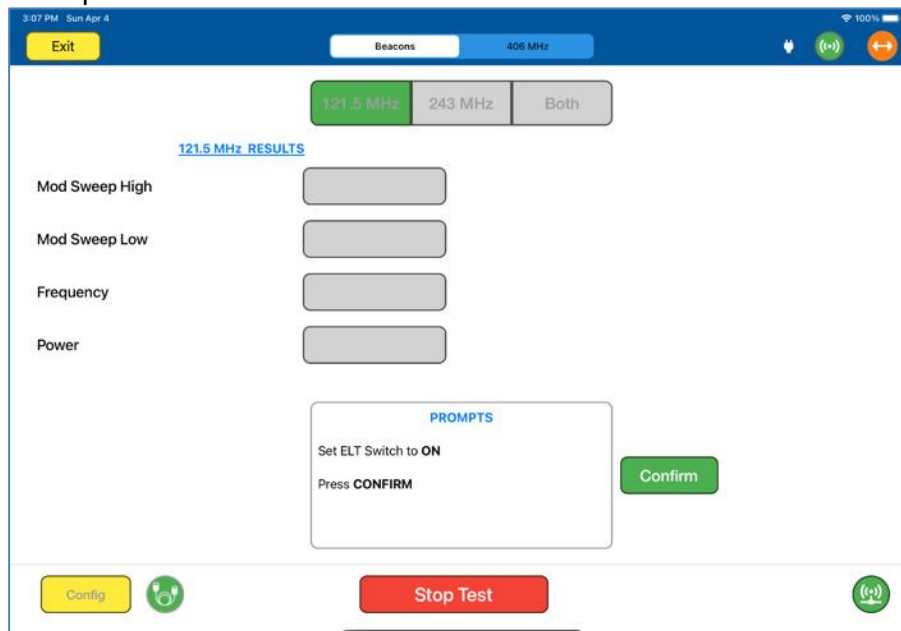

4.7. When the ELT is switched on **Confirm** should be selected as quickly as possible. This initiates a 20 second count down during which the ARTS is receiving the beacon information.

NOTE: the ELT should not be switched on for more than 20 seconds. 20 seconds is the maximum time the ELT should be transmitting. Once valid data is received or the 20 seconds is finished the ELT should be switched off.

4.8. The following example screen shows valid data with the timer at 2 seconds remaining.



4.9. When the timer reaches zero the following test result screen will be displayed – this screen shot is for the 121.5MHz Beacon selection.

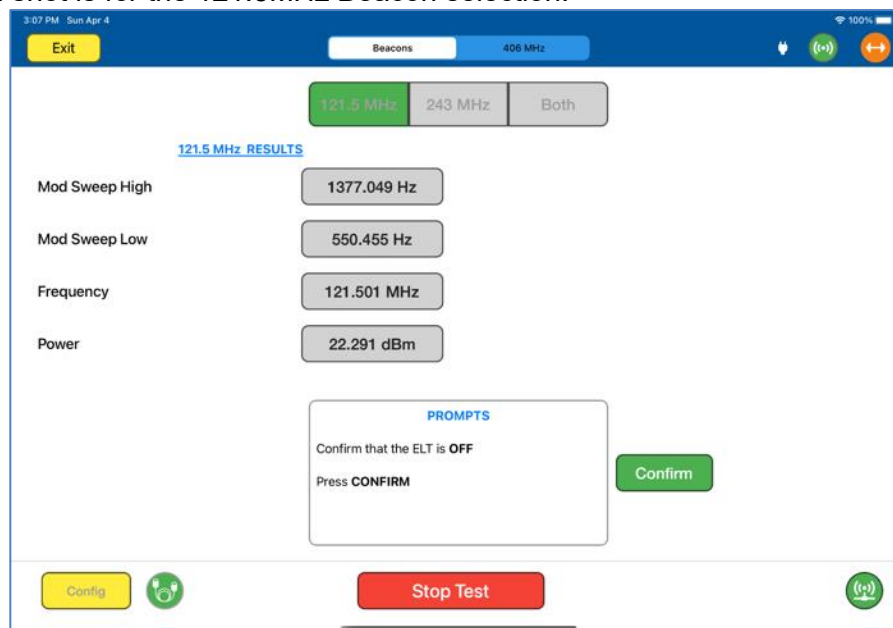

- 4.10. The User must confirm that the ELT is OFF.
- 4.11. The user should note the values received.
- 4.12. In the case of both beacons being tested the results screen will appear as follows.



- 4.13. Selecting Stop Test returns the Application to the original ELT test page.

ELT Test Controls and Selections

Item	Description
Mod Sweep High	Highest frequency of the modulated sweep. Only available on 121.5 and 243 MHz ELTs
Mod Sweep Low	Lowest frequency of the modulated sweep. Only available on 121.5 and 243 MHz ELTs
Frequency	Indicates the frequency of the ELT transmission. Only available on 121.5 and 243 MHz ELTs
Power	Not available when testing over the air with antenna. When utilizing a cable connection this field indicates the power radiated from the ELT under test.

SECTION 17: DISTANCE MEASURING EQUIPMENT (DME)

SUBSECTION 1: DME OPERATION

WARNING

It is extremely dangerous to generate signals during testing that are on the frequencies that are in use by local ATC. When operating the test set in DME Mode. Please be aware of the local navigation aid and ATC frequencies. It is the test set operator's responsibility to make sure all testing is carried out on frequencies that will not interfere with local navigation aids or ATC resources.

Hardware Required

Item	Test Type	Description / Notes	Part Number
Pulse Antenna	Ant - Ant	Yellow flat plate Pulse antenna	123-0230
Tripod	Ant - Ant	Required to mount antenna.	118-2286
Coax Cable option of 6, 20 or 60 ft	Ant - Ant Dir - Cable	Ant-Ant Operator choice of length to allow satisfactory positioning of test antenna to achieve a clear line of site to the Aircraft antenna under test. Dir- Cbl - operator choice of length recommended to use shortest possible.	VARIOUS
Coupler	Ant - Coupler	Antenna Coupler	123-0237

DME Test Selection

1. From the Main Menu select **Test Functions**.
2. From the Functions Menu select **DME**.
3. From the DME Menu select **DME**.
4. The DME test Screen is now displayed.

DME Test Configuration

Before running the test, operators can use the default mode by pressing the **Default** button or accessing the config page via the **Config** button to establish the user preferences.

The ARTS 7000 stores the last configuration used and has a default setting. When the **Default** button on the test screen is pressed the ARTS 7000 automatically sets the default mode and settings.

Please See Appendix C for Default and Preset settings.

DME Test Configuration Screen

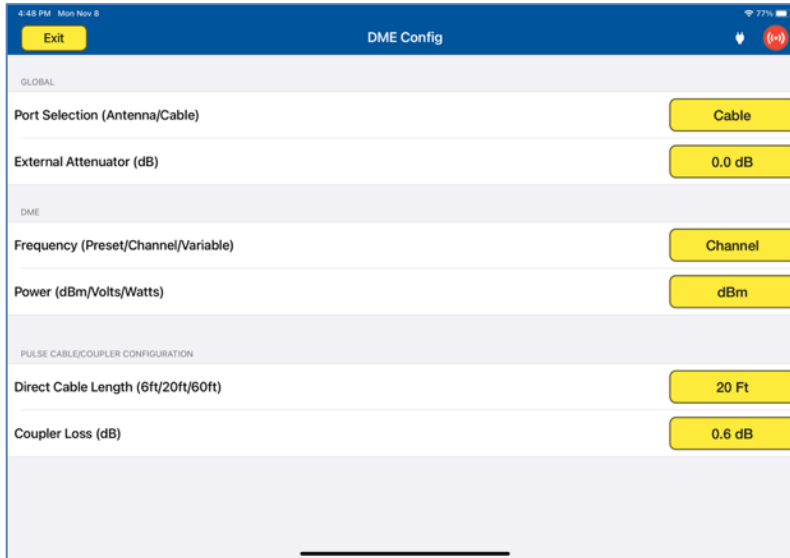

DME Test Configuration Controls and Selections

Item	Description
Port Selection (Cable/Antenna)	Selects the over the air (Antenna) connection Port, the Direct (Cable) Connection Port or the Coupler through the Cable connection port.
External Attenuator (dB)	When an attenuator is used the value of the attenuator should be entered in this field.
Frequency (Preset/Channel/Variable)	Allows the selection of the test DME Frequency. Selections are Preset (Laversab defined), Channel (Standard DME frequencies) or Variable.
Power (dBm/Volts/Watts)	Allows the selection of the test power units for the DME Signal. Selections are dBm, Volts, or Watts.
Ant Cable Length (6ft/20ft/60ft) (Not shown above)	Selects the length of the cable used between the ARTS 7000 antenna connector and the ARTS 7000 pulse antenna. This allows the ARTS 7000 to account for the loss in the cable. Only required on an antenna to antenna (over the air) connection.
Ant Range (Not shown above)	This field identifies the range from the ARTS 7000 pulse antenna to the Aircraft DME Antenna in Feet.

Ant Height <i>(Not shown above)</i>	This field identifies vertical height between the ARTS 7000 pulse antenna and the Aircraft DME Antenna in Feet.
Direct Cable Length <i>(6ft/20ft/60ft)</i>	Selects the length of the cable used between the ARTS 7000 direct connection connector and the Aircraft Radio or feeder. This allows the ARTS 7000 to account for the loss in the cable. Only required on an ARTS 7000 direct cable connection to the LRU (not over the air) connection.
Coupler Loss (dB)	Predetermined typical loss through Coupler. The value should be listed on the coupler itself.

DME Test Screen



DME Test Controls and Selections

Item	Description
Reply Freq. <input type="text" value="998.000 MHz"/>	Frequency of the ARTS 7000 generated DME signal.
NAV Freq. <input type="text" value="110.000 MHz"/>	The frequency of the Nav element that is paired to the DME frequency.
Channel <input type="text" value="X"/>	DME channel selection - X or Y.

Power	<input type="text" value="-33.500 dBm"/>	Power output of the ARTS 7000 generated DME signal.
Rate KTS	<input type="text" value="100.0 Knots"/>	Set the aircraft pseudo-speed in relation to the DME beacon to create a flight scenario.
Range NM	<input type="text" value="25.0 NM"/>	Sets the aircraft pseudo-range in relation to the DME beacon to create a flight scenario.
% Replies	<input type="text" value="100 %"/>	Sets the percentage of replies by the DME beacon to the aircraft interrogation signal.
SQTR	<input type="text" value="On"/>	Sets Squitter On or Off. Squitter must be On to enable DME to successfully track.
ECHO	<input type="text" value="Off"/>	Allows a pseudo echo or multi-path reply from DME beacon to the test aircraft interrogation signal.
TX Frequency	<input type="text"/>	Indicates the received frequency from the test aircraft/LRU.
TX Power	<input type="text"/>	Indicates the received Power from the test aircraft/LRU.
P1 Width	<input type="text"/>	Indicates the pulse width of the P1 Pulse from the Aircraft/LRU interrogation.
P2 Width	<input type="text"/>	Indicates the pulse width of the P2 Pulse from the Aircraft/LRU interrogation.
P1-P2 Spacing	<input type="text"/>	Indicates the pulse spacing between the P1 & P2 pulses from the Aircraft/LRU interrogation.
PRF	<input type="text"/>	Indicates the Pulse Repetition Frequency of the interrogation signal from the Aircraft/LRU.
	<input type="text" value="-"/>	During an active test this field displays the instantaneous distance from the aircraft to the ARTS 7000 pseudo DME beacon. The displayed values should match the Aircraft cockpit displayed value.
	<input type="text" value="IN"/> <input type="text" value="OUT"/>	During the active test, user can instantaneous switch between "To the Beacon" and "From the Beacon" scenarios.

Subsection 2: DME Test Control Details

1. **Frequency:** Sets the frequency of the ARTS 7000 generated reply DME frequency.
Note: when the test is running the frequency can be adjusted.
2. **Nav Frequency:** Entering a valid Nav frequency in this field will automatically tune ARTS 7000 to the paired DME beacon frequency.
3. **Power:** Sets the power of the ARTS 7000 generated DME signal.
Note: when the test is running the power can be adjusted
4. **Rate KTS:** This field is used to set up the airspeed of the test scenario, measured in knots. This simulates the closing speed of the aircraft to the pseudo DME beacon generated by the ARTS 7000.
5. **Range NM:** This field is used to set up the start distance of the test scenario, measured in Nautical Miles. This simulates the initial distance between aircraft and the pseudo DME beacon generated by the ARTS 7000.
6. **% Replies:** The % replies can be adjusted from 0-100%. This allows the response from the ARTS 7000 to be artificially degraded to confirm correct operation of the DME in low signal or signal loss conditions.
7. **SQTR:** Squitter can be switched On or Off. For the DME to search, track, and lock correctly, Squitter should be On.
8. **ECHO:** Echo can be switched On or Off. With echo On the ARTS provides a simulated multipath echo signal. This is used to confirm the DME is locked on to the “real” signal and not the echo reply. In normal operation Echo is set to Off.
9. **TX Frequency (indicator):** This field indicates the transmitted signal frequency from the Aircraft that is received by the ARTS 7000.
10. **TX Power (indicator):** This field indicates the transmitted signal power from the Aircraft that is received by the ARTS 7000.
11. **P1 Width (Indicator):** This field indicates the width of the P1 pulse that is generated from the aircraft interrogator.
12. **P2 Width (indicator):** This field indicates the width of the P2 pulse that is generated from the aircraft interrogator.
13. **P1 – P2 Spacing (indicator):** This field indicates the spacing between the P1 and P2 interrogation pulses generated from the aircraft interrogator.
14. **PRF (indicator):** This field indicates the Pulse Repetition Frequency of the interrogation pulses transmitted to the ARTS 7000 from the aircraft interrogator.

SECTION 18: MODE S TRANSPONDERS

SUBSECTION 1: MODE S OPERATION

WARNING

It is extremely dangerous to generate signals during testing that are on the frequencies that are in use by local ATC. When operating the test set in Mode S mode, please be aware of the local navigation aid and ATC frequencies. It is the test set operator's responsibility to make sure all testing is carried out on frequencies that will not interfere with local navigation aids or ATC resources.

Hardware Required

Item	Test Type	Description / Notes	Part Number
Pulse Antenna	Ant - Ant	Yellow flat plate Pulse antenna	123-0230
Tripod	Ant - Ant	Required to mount antenna	118-2286
Co Ax Cable option of 6, 20 or 60 ft	Ant - Ant	Ant-Ant Operator choice of length to allow satisfactory positioning of test antenna to achieve a clear line of sight to the Aircraft antenna under test.	VARIOUS
	Dir - Cable	Dir - Cbl – operator choice of length recommended to use shortest possible.	
Coupler	Ant - Coupler	Antenna Coupler See the Antenna Coupler Section of this document	123-0237

WARNING

All ARTS 7000 Mode S transponder testing is carried out in accordance with Far 43 Appendix F requirements. Please ensure that using the ARTS 7000 that you are aware of the specific requirements of FAR 43 Appendix F and any other local transponder testing requirements.

MODE S Test – Different test options

There are several Mode S tests that the ARTS 7000 can complete. All tests operate similarly but with differing levels of performance. It is the operator's choice as to which tests are applicable. From the Mode S top-level menu, specific tests can be selected. All MODE S tests break out the specific parameters of the MODE S reply. This enables the operator to understand and review the results quickly.

SUBSECTION 2: MODE S TEST GUIDE

WARNING

It is extremely dangerous to generate signals during testing that are on the frequencies that are in use by local ATC. When operating the test set in Mode S mode. Please be aware of the local navigation aid and ATC frequencies. It is the test set operator's responsibility to make sure all testing is carried out on frequencies that will not interfere with local navigation aids or ATC resources.

WARNING

Testing a top antenna often requires the use of gantries and/ or high-level platforms. This is because it is essential to get a to get a good line of sight on the top antenna. It is advised to use caution in these circumstances and make sure the operator ensures their safety and that of others. Please ensure the antenna is secured safely and cannot easily fall.

WARNING

Please be aware of putting an aircraft to a test altitude. Under this circumstance, when the MODE S is Active and the aircraft system is at an altitude, the aircraft under test will appear as a live aircraft to ATC, and other aircraft may experience false TCAS advisories.

This situation is very dangerous and may be subject to legal or financial actions.

Hints and Tips

When testing any Transponder, DME, or TCAS, ensure the reflective paths are minimized from equipment that is near the aircraft. Try to select a line of sight between the ARTS antenna and the Aircraft antenna that does not have any obstruction in front or behind them. For example: Ground Power Units, Aircraft Landing Gear, Aircraft Stairs, Toolboxes etc.

Hints and Tips

When testing transponders, if Power failures are identified it is recommended to move the test antenna slightly in the horizontal plane and retest the transponder.

Antenna alignment is critical to successful testing of transponders. The ARTS 7000 pulse antenna is highly directional in both x- and y- planes and must be positioned in such a way that the center point of the antenna is pointed as accurately as possible to the aircraft antenna under test.

Failure to get good alignment results in a higher likelihood of poor interrogations, reflections, and multi-path issues.



ARTS 7000 Pulse antenna showing good alignment with an aircraft bottom antenna.

Please see the section on Pulse Antenna Alignment, Reflections and Multi-path.

1. Transponder testing may take > 20 minutes depending on the capability of the transponder. It is recommended to choose the basic test first as it is relatively fast. Once the basic test is completed successfully the full test can be run.
2. It is good practice to screen the antenna not under test using a suitable antenna screen. A secondary Laversab Coupler can be used as a screen with the 50 Ohm terminating connector.
3. Using an antenna coupler is highly recommended to reduce radiation of the interrogation and reply signals. Please contact Laversab for details.
4. To achieve good transponder tests, it is critical that the aircraft is in the correct status (i.e. in "Air mode"). Additionally other systems may need to be operating for the transponder to squitter data. For example, GPS position will only be available if the aircraft has valid GPS signals.

MODE S Test Selection

1. From the Main Menu select **Test Functions**.
2. From the Functions menu select **ATC**.
3. From the ATC Menu select **Mode S**.
4. From the MODE S menu select which Mode S Test is required – Generic, Class A, or Class B.
5. The relevant Mode S test Screen is now displayed.

MODE S Test Configuration

Before running the Test, operators can access the configuration page via the CONFIG button to establish the user preferences. The ARTS 7000 will store the last configuration used.

MODE S Test Configuration Screen

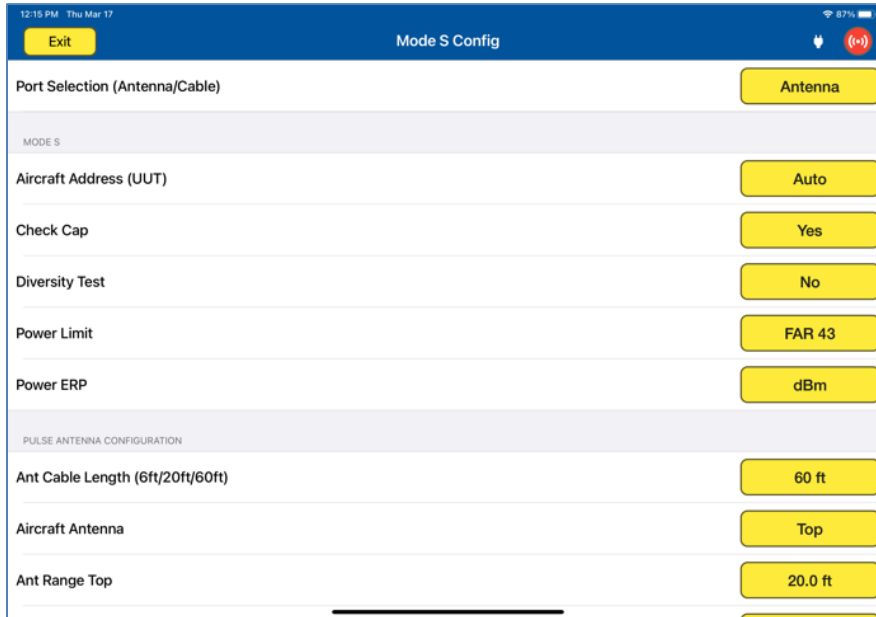

The screenshot shows the 'Mode S Config' screen with the following settings:

- Port Selection (Antenna/Cable): Antenna
- Aircraft Address (UUT): Auto
- Check Cap: Yes
- Diversity Test: No
- Power Limit: FAR 43
- Power ERP: dBm
- Ant Cable Length (6ft/20ft/60ft): 60 ft
- Aircraft Antenna: Top
- Ant Range Top: 20.0 ft

MODE S Test Configuration Controls and Selections

Item	Description
Port Selection (Antenna/Cable)	Selects the over the air (Antenna) connection Port, the Direct (Cable) Connection Port, or Direct connection Port with a Coupler (Cable w/ Coupler).
External Attenuator (dB) <i>(not shown above)</i>	When an attenuator is used the value of the attenuator should be entered in this field.
Aircraft Address (UUT)	Selects whether the Address is entered manually or automatically identified by the aircraft under test reply.
Aircraft Address (Manual)	Field for entering the Mode S Address in Hexadecimal value - if known.
Check Cap	Select if the capability of the transponder is to be checked.
Diversity Test	'Yes' for a diversity aircraft installation (Top & Bottom antenna) 'No' for a non-diverse aircraft installation (single antenna).
Power Limit	'FAR 43' specification or 'Unlimited'. FAR 43 is recommended.
Power ERP	Selection of units for power measurement - Watts or dBm.

Ant Cable Length (6ft/20ft/60ft)	Selects the length of the cable used between the ARTS 7000 antenna connector and the ARTS 7000 pulse antenna. ARTS 7000 will account for the loss in the cable. Only required on an antenna to antenna (over the air) connection.
Aircraft Antenna	Select which antenna is to be tested top or bottom in a dual antenna installation. Set to bottom for a single antenna installation.
Ant Range Top	Horizontal distance from the ARTS 7000 antenna to the aircraft top antenna entered (ft). Does not have to be 100% accurate.
Ant Height Top	Vertical height from the ARTS 7000 antenna to the aircraft top antenna entered (ft). Does not have to be 100% accurate.
Ant Range Bot (Not shown above)	Horizontal distance from the ARTS 7000 antenna to the aircrafts bottom antenna entered (ft). Does not have to be 100% accurate.
Ant Height Bottom (Not shown above)	Vertical height from the ARTS 7000 antenna to the aircraft bottom antenna entered (ft). Does not have to be 100% accurate.
Direct Cable Length (6ft/20ft/60ft) (Not shown above)	When testing MODE S over a direct/cable connection – this field is used to identify which length of coax cable that is being used between the ARTS 7000 connector and the aircraft antenna feeder or antenna connector. This length is used to account for the loss in the cable.
Coupler Loss (dB) (Not shown above)	Predetermined typical loss through Coupler. The value should be listed on the coupler itself.

Mode S Test Screen

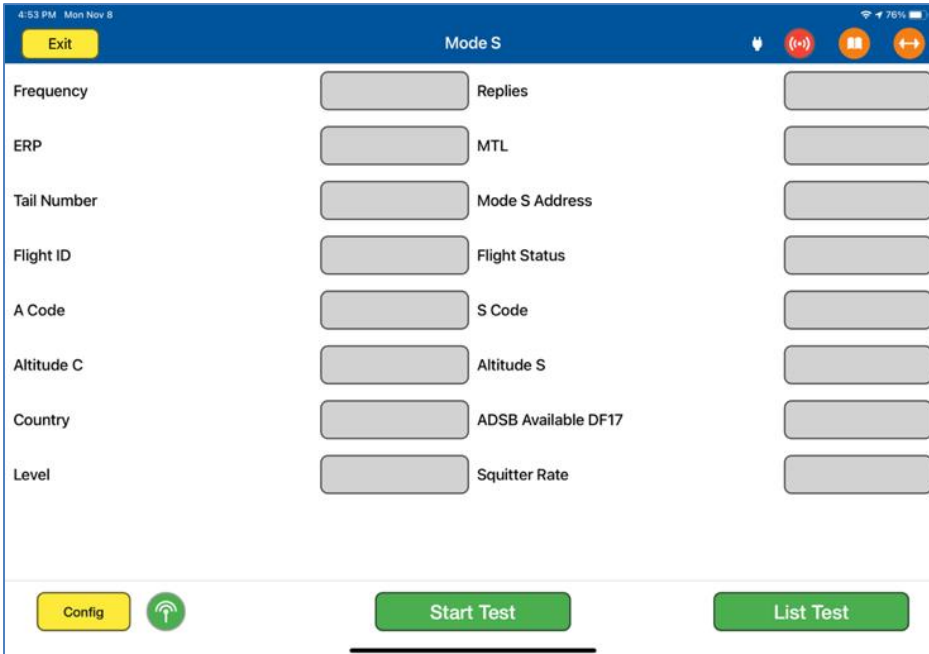

The screenshot shows the Mode S Test Screen on a mobile device. The screen has a blue header with the title "Mode S" and an "Exit" button. Below the header, there are several input fields for configuration: Frequency, ERP, Tail Number, Flight ID, A Code, Altitude C, Country, and Level. Each of these fields is paired with a corresponding field for the test parameters: Replies, MTL, Mode S Address, Flight Status, S Code, Altitude S, ADSB Available DF17, and Squitter Rate. At the bottom of the screen, there are three buttons: "Config", "Start Test", and "List Test". The "Config" button is yellow, and the "Start Test" and "List Test" buttons are green. The status bar at the top shows the time as 4:53 PM on Monday, November 8, and the battery level at 76%.

Mode S Test Controls and Selections

Item	Description
Frequency	Received frequency of the Aircraft transponder reply to ARTS 7000 interrogation.
Replies	Percent of replies received from the Aircraft with respect to the number of interrogations sent by ARTS 7000.
ERP	Effective Radiated Power received from the Aircraft reply transmission.
MTL	Minimum Trigger Level received from the Aircraft reply transmission.
Tail Number	Aircraft tail number decoded from the Mode S reply.
Mode S Address	Aircraft Mode S Address decoded from the Mode S reply.
Flight ID	Aircraft Flight ID decoded from Mode S reply.
Flight Status	Aircraft Flight status decoded from Mode S reply.
A Code	Mode A code decoded from reply transmission.
S Code	Mode S code decoded from reply transmission.
Altitude C	Mode C altitude decoded from reply transmission.
Altitude S	Mode S altitude decoded from reply transmission.
Country	Aircraft country of registration decoded from reply transmission.

ADSB Available DF 17	Indication that ADSB is installed and available for interrogation based on reply transmission. Perform DF17 Test for detailed results.
Level	Level of transponder under interrogation decoded from reply transmission.
Squitter Rate	Rate of message transmission.

List of Supported Countries

Country	Prefix	Country	Prefix
United States	N	Singapore	9V
Canada	C	South Africa	ZS
Australia	VH	Belgium	OO
Portugal	CS	Denmark	OY
Romania	YR	Finland	OH
Switzerland	HB	Greece	SX
Turkey	TC	Germany	D
Yugoslavia	YU	Russia	RA
France	F	Cuba	CU
Argentina	LV	Pakistan	AP
Japan	JA	Jordan	JY
South Korea	HL	Syria	YK

Test Selections

After starting the test, the operator can select the specific Mode S parameters to test.

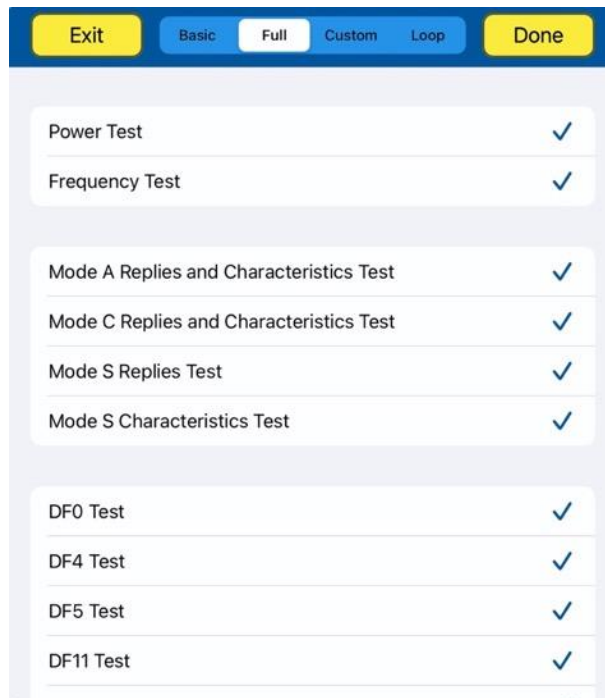

Test Selection pop-up screen.

Test Name	Description
Basic	The BASIC test is a quick verification test of the key parameters of the transponder. This test includes the frequency, power, and pulse characteristic checks of the reply only. This test does <u>not</u> meet the specific requirements of Far 43 Appendix F.
Full	The Full test exercises all parameters of the transponder reply. This test is carried out in accordance with the requirements of FAR 43 Appendix F.
Custom	The CUSTOM Test allows the operator to specify which tests are to be performed. Selections are indicated with a checkmark. This test does <u>not</u> meet the specific requirements of Far 43 Appendix F.
Loop	The LOOP Test allows the operator to specify which tests are to be performed. The test will loop through the selected tests. This test does <u>not</u> meet the specific requirements of Far 43 Appendix F.

Antenna Alignment Tool

Used for Antenna-to-Antenna connection only.

When the test is started, the ARTS 7000 Application will automatically launch the Antenna Alignment tool. This tool can ensure the best possible Antenna alignment before the test starts.

The tool displays live updated Transponder % replies and ERP. While the tool is running the operator can adjust the antenna position to ensure the highest possible returned values to ensure the best quality over-the-air connection to the aircraft.

The tool also displays the Antenna (top/bottom), the Antenna Range and the Antenna Height. During alignment, these values can be adjusted to get an optimal signal.

Once the % replies and the ERP are sufficient, the test can be started.

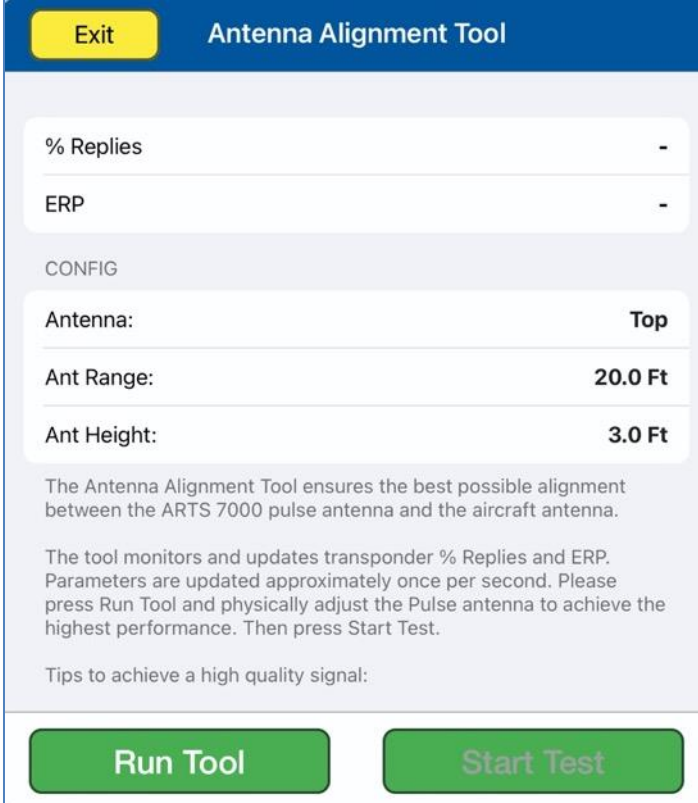

Antenna Alignment Tool	
% Replies	-
ERP	-
CONFIG	
Antenna:	Top
Ant Range:	20.0 Ft
Ant Height:	3.0 Ft
The Antenna Alignment Tool ensures the best possible alignment between the ARTS 7000 pulse antenna and the aircraft antenna.	
The tool monitors and updates transponder % Replies and ERP. Parameters are updated approximately once per second. Please press Run Tool and physically adjust the Pulse antenna to achieve the highest performance. Then press Start Test.	
Tips to achieve a high quality signal:	
Run Tool	Start Test

Antenna Alignment tool

SUBSECTION 3: MODE S RESULTS SCREEN

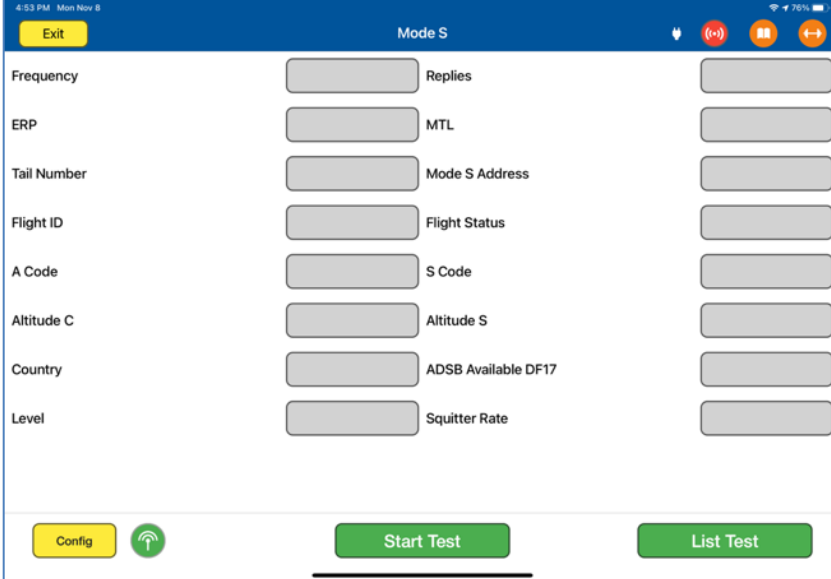

1. Above is the main test screen for Mode S. During the test and after the test is complete, the fields will be populated with relevant data.
2. Once the test is complete the ARTS 7000 stores the results that can be viewed and downloaded from the **Utilities>Records** menu.
3. Test Results shown in Green have passed the specification those shown in Red have failed.
4. When the test is completed, the **LIST TEST** button will launch the screen below.

Note: Depending on which version of test was run, test results can vary. The image below is for the Full Mode S test.

List Test Screen

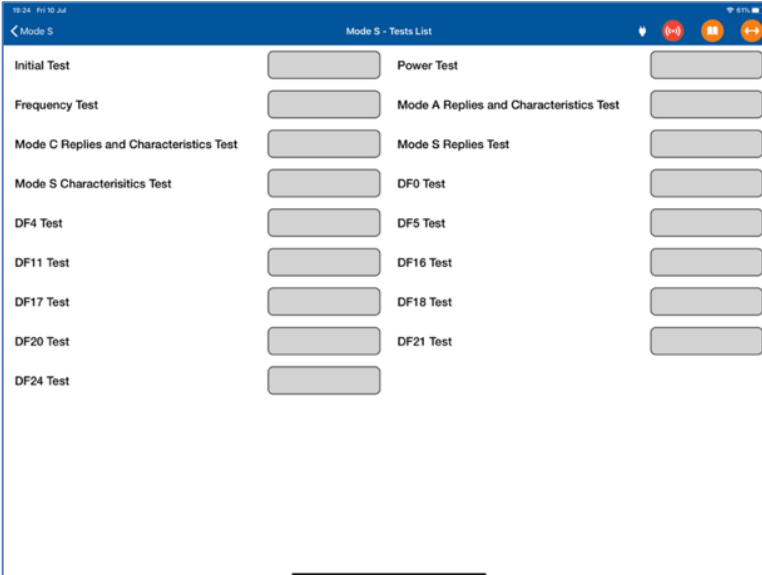

Select any of the results fields to review the specific modules test results.

Item	Description of module contents
Initial Test	This links back to the summary test results screen.
Power Test	ERP and MTL levels received from the Transponder under test replies.
Frequency Test	Frequencies of the MODE S and ATCRBS replies from the Aircraft.
Mode A Reply and Characteristics	Mode A specific characteristics including pulse and pulse spacing measurement, low and high limit responses.
Mode C Reply and Characteristics	Mode C specific characteristics including pulse and pulse spacing measurement, low and high limit responses.
Mode S Replies Test	Mode S specific responses to All Call and Intermoder reply tests
Mode S Characteristics	Mode S specific pulse characteristics
DF0	Short air-air surveillance data
DF4	Altitude reply
DF5	Identity reply
DF11	All-call reply
DF16	Long air-air surveillance
DF17	ADS-B Extended squitter
DF18	ADS-B Extended squitter, non-transponder
DF20	Comm-B, with altitude reply
DF21	Comm-B, with identity reply
DF24	Comm-D, extended length message

Test Results Screen Details

Screen shots of Mode S Module Test Results (Example data)

Note: When available, the relevant BDS registers are accessed through the title bar of the results screen.

Power Test Results Screen

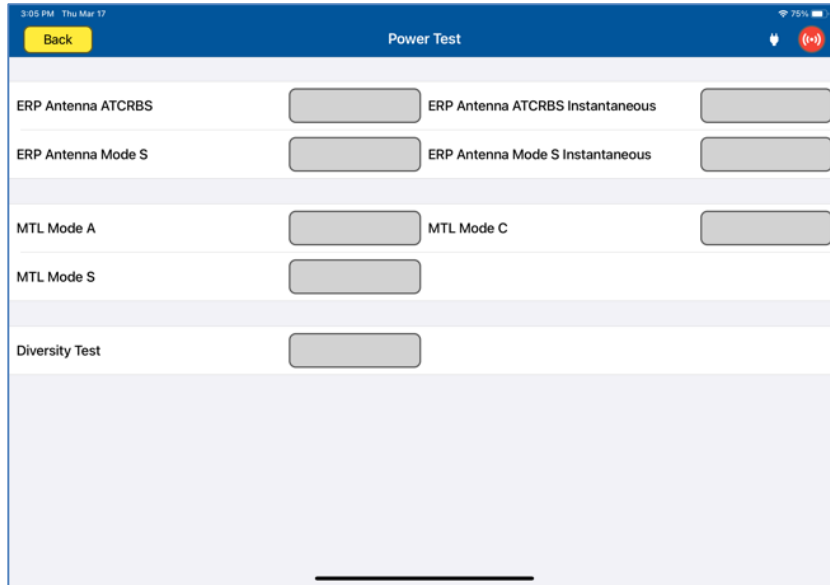

The screenshot shows the 'Power Test' results screen. The title bar at the top is blue and contains a yellow 'Back' button on the left, the text 'Power Test' in the center, and a red circular icon with a white signal strength indicator on the right. The main content area is white and contains several rows of test results, each with a grey rectangular input field to its right. The rows are: 'ERP Antenna ATCRBS' and 'ERP Antenna ATCRBS Instantaneous'; 'ERP Antenna Mode S' and 'ERP Antenna Mode S Instantaneous'; 'MTL Mode A' and 'MTL Mode C'; 'MTL Mode S'; and 'Diversity Test'. The bottom of the screen shows a black horizontal bar, likely representing the home indicator on an iPhone.

Frequency Test Results Screen

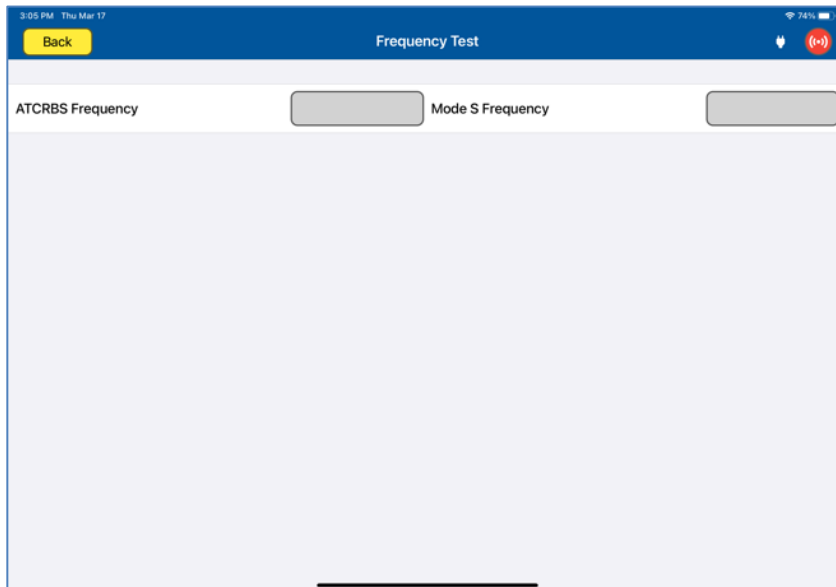

The screenshot shows the 'Frequency Test' results screen. The title bar at the top is blue and contains a yellow 'Back' button on the left, the text 'Frequency Test' in the center, and a red circular icon with a white signal strength indicator on the right. The main content area is white and contains two rows of test results, each with a grey rectangular input field to its right. The rows are: 'ATCRBS Frequency' and 'Mode S Frequency'. The bottom of the screen shows a black horizontal bar, likely representing the home indicator on an iPhone.

Mode A Replies and Characteristics Test Results Screen

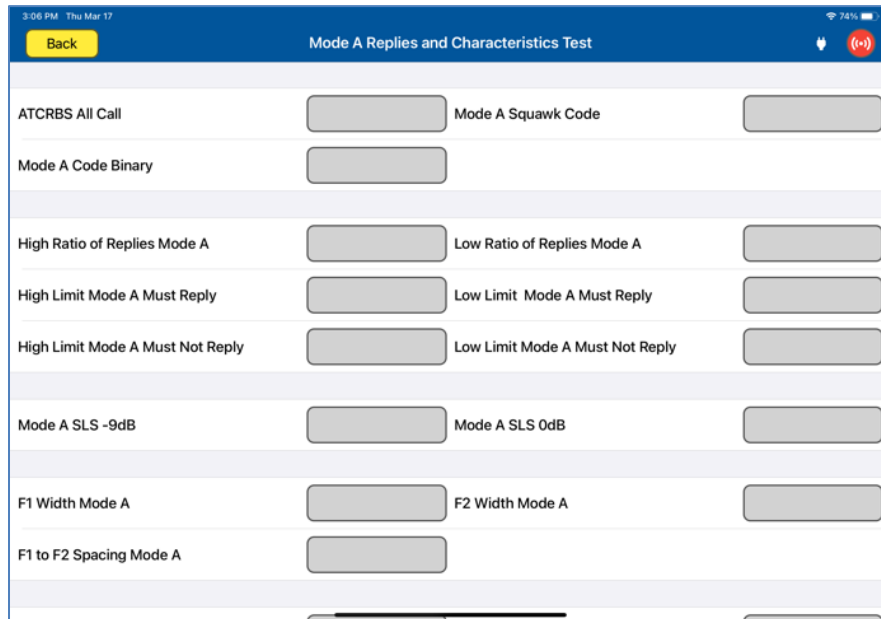

The screenshot shows a mobile application interface for testing Mode A replies. The title bar is blue with a 'Back' button on the left and a home indicator on the right. The main content area is white with a light blue header. The test parameters are organized into rows, each with a label and a corresponding input field. The parameters include ATCRBS All Call, Mode A Squawk Code, Mode A Code Binary, High Ratio of Replies Mode A, Low Ratio of Replies Mode A, High Limit Mode A Must Reply, Low Limit Mode A Must Reply, High Limit Mode A Must Not Reply, Low Limit Mode A Must Not Reply, Mode A SLS -9dB, Mode A SLS 0dB, F1 Width Mode A, F2 Width Mode A, and F1 to F2 Spacing Mode A.

Parameter	Input Field
ATCRBS All Call	<input type="text"/>
Mode A Squawk Code	<input type="text"/>
Mode A Code Binary	<input type="text"/>
High Ratio of Replies Mode A	<input type="text"/>
Low Ratio of Replies Mode A	<input type="text"/>
High Limit Mode A Must Reply	<input type="text"/>
Low Limit Mode A Must Reply	<input type="text"/>
High Limit Mode A Must Not Reply	<input type="text"/>
Low Limit Mode A Must Not Reply	<input type="text"/>
Mode A SLS -9dB	<input type="text"/>
Mode A SLS 0dB	<input type="text"/>
F1 Width Mode A	<input type="text"/>
F2 Width Mode A	<input type="text"/>
F1 to F2 Spacing Mode A	<input type="text"/>

Mode C Replies and Characteristics Test Results Screen

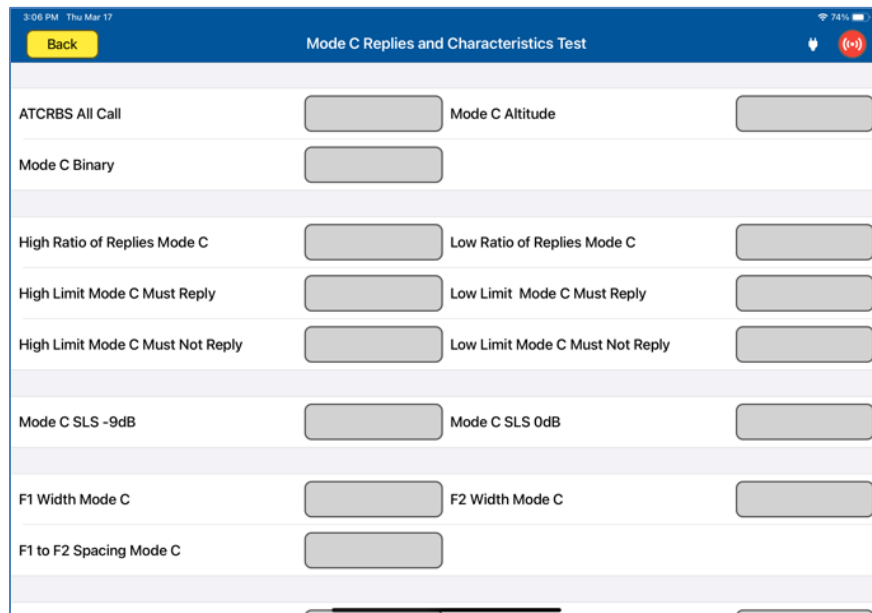

The screenshot shows a mobile application interface for testing Mode C replies. The title bar is blue with a 'Back' button on the left and a home indicator on the right. The main content area is white with a light blue header. The test parameters are organized into rows, each with a label and a corresponding input field. The parameters include ATCRBS All Call, Mode C Altitude, Mode C Binary, High Ratio of Replies Mode C, Low Ratio of Replies Mode C, High Limit Mode C Must Reply, Low Limit Mode C Must Reply, High Limit Mode C Must Not Reply, Low Limit Mode C Must Not Reply, Mode C SLS -9dB, Mode C SLS 0dB, F1 Width Mode C, F2 Width Mode C, and F1 to F2 Spacing Mode C.

Parameter	Input Field
ATCRBS All Call	<input type="text"/>
Mode C Altitude	<input type="text"/>
Mode C Binary	<input type="text"/>
High Ratio of Replies Mode C	<input type="text"/>
Low Ratio of Replies Mode C	<input type="text"/>
High Limit Mode C Must Reply	<input type="text"/>
Low Limit Mode C Must Reply	<input type="text"/>
High Limit Mode C Must Not Reply	<input type="text"/>
Low Limit Mode C Must Not Reply	<input type="text"/>
Mode C SLS -9dB	<input type="text"/>
Mode C SLS 0dB	<input type="text"/>
F1 Width Mode C	<input type="text"/>
F2 Width Mode C	<input type="text"/>
F1 to F2 Spacing Mode C	<input type="text"/>

Mode S Replies Test Results Screen

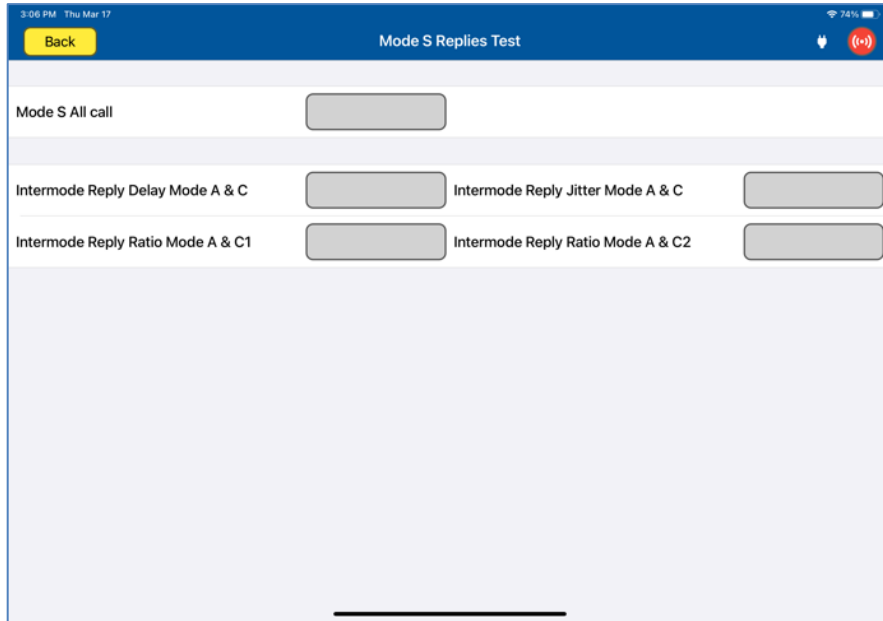

Mode S Characteristics Test Results Screen

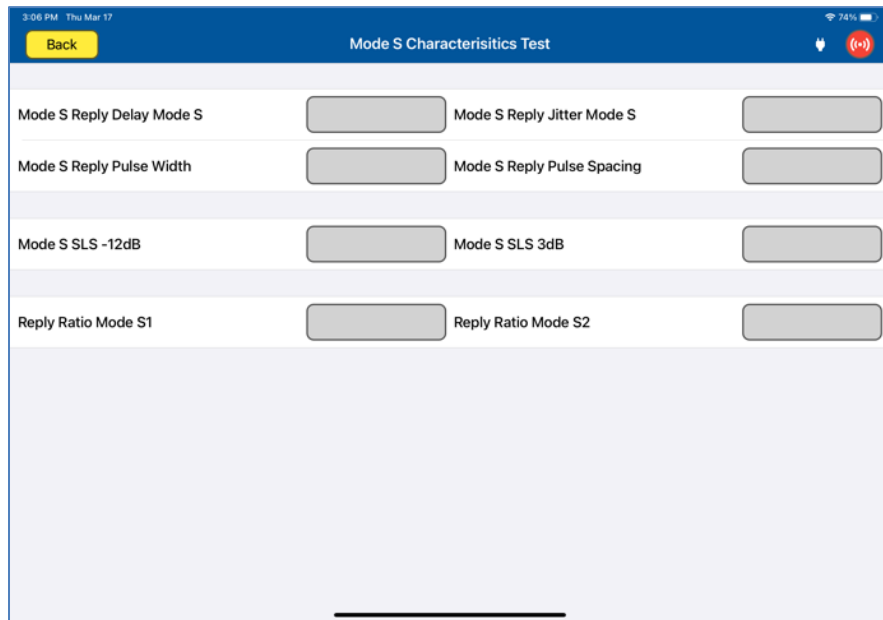

DF0 Test Results Screen

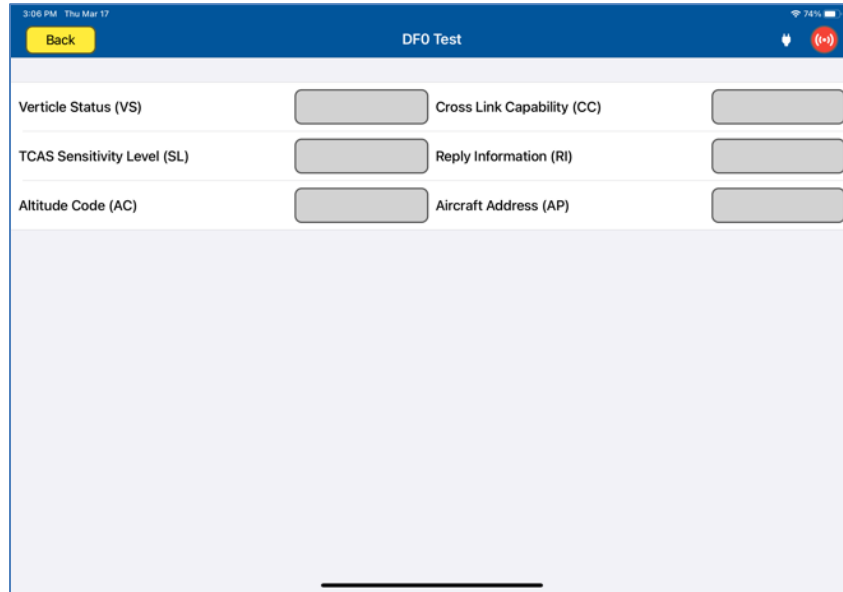

The screenshot shows a mobile application interface for the DF0 Test Results screen. At the top, there is a blue header bar with a yellow 'Back' button on the left, the title 'DF0 Test' in the center, and a red '(x)' icon on the right. Below the header, the screen is divided into three rows of input fields. Each row contains two labels and two corresponding input boxes. The first row has 'Verticle Status (VS)' and 'Cross Link Capability (CC)'. The second row has 'TCAS Sensitivity Level (SL)' and 'Reply Information (RI)'. The third row has 'Altitude Code (AC)' and 'Aircraft Address (AP)'. The input boxes are currently empty. The bottom of the screen shows a white background with a black horizontal line at the very bottom, indicating a mobile device interface.

DF4 Test Results Screen

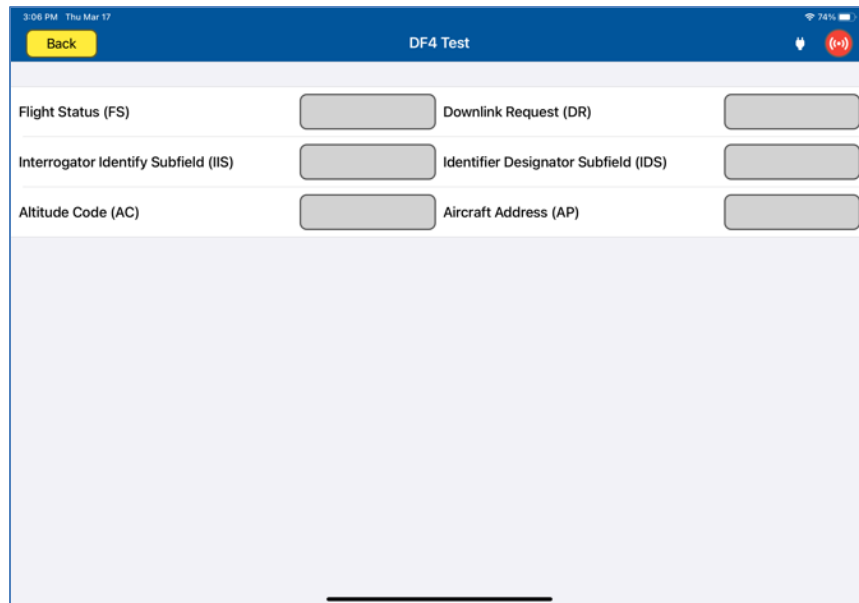

The screenshot shows a mobile application interface for the DF4 Test Results screen. At the top, there is a blue header bar with a yellow 'Back' button on the left, the title 'DF4 Test' in the center, and a red '(x)' icon on the right. Below the header, the screen is divided into three rows of input fields. Each row contains two labels and two corresponding input boxes. The first row has 'Flight Status (FS)' and 'Downlink Request (DR)'. The second row has 'Interrogator Identify Subfield (IIS)' and 'Identifier Designator Subfield (IDS)'. The third row has 'Altitude Code (AC)' and 'Aircraft Address (AP)'. The input boxes are currently empty. The bottom of the screen shows a white background with a black horizontal line at the very bottom, indicating a mobile device interface.

DF5 Test Results Screen

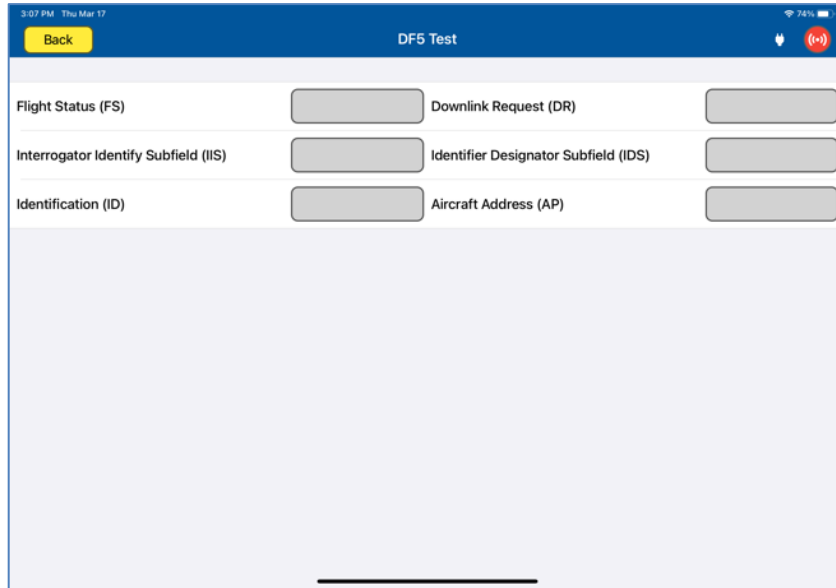

The screenshot shows a mobile application interface for the DF5 Test. At the top, there is a blue header bar with the text "DF5 Test" in the center. On the left of the header is a yellow "Back" button, and on the right are a home indicator and a red "X" icon. Below the header, the screen is divided into three rows of input fields. The first row contains "Flight Status (FS)" and "Downlink Request (DR)". The second row contains "Interrogator Identify Subfield (IIS)" and "Identifier Designator Subfield (IDS)". The third row contains "Identification (ID)" and "Aircraft Address (AP)". Each label is followed by a grey rectangular input field. The bottom of the screen shows a home indicator bar.

DF11 Test Results Screen

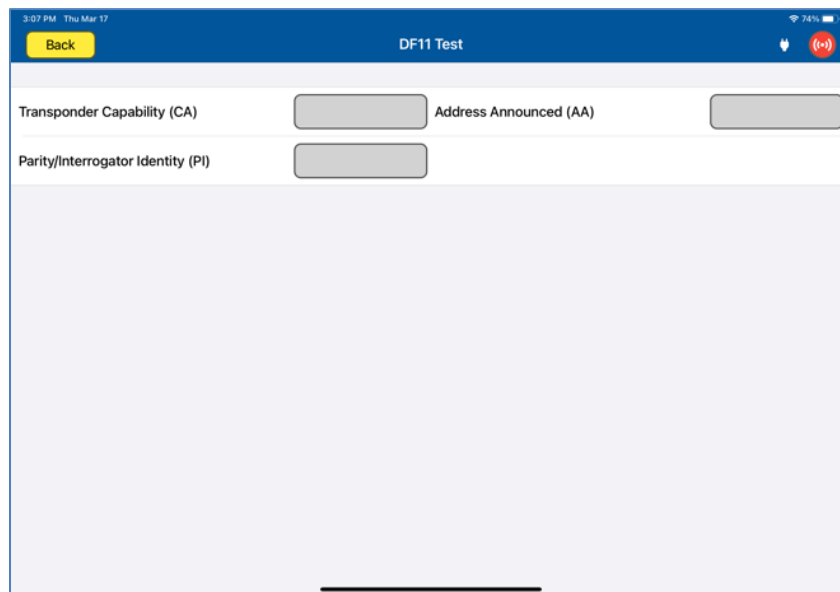

The screenshot shows a mobile application interface for the DF11 Test. At the top, there is a blue header bar with the text "DF11 Test" in the center. On the left of the header is a yellow "Back" button, and on the right are a home indicator and a red "X" icon. Below the header, the screen is divided into two rows of input fields. The first row contains "Transponder Capability (CA)" and "Address Announced (AA)". The second row contains "Parity/Interrogator Identity (PI)". Each label is followed by a grey rectangular input field. The bottom of the screen shows a home indicator bar.

DF16 Test Results Screen

3:07 PM Thu Mar 17 74%

Back DF16 Test

Vertical Status (VS)	<input type="text"/>	TCAS Sensitivity Level (SL)	<input type="text"/>
Reply Information (RI)	<input type="text"/>	Altitude Code (AC)	<input type="text"/>
Aircraft Address (AP)	<input type="text"/>		
VDS 3.0			
Active Resolution Advisory (ARA)	<input type="text"/>	Resolution Advisory Complement (RAC)	<input type="text"/>
Resolution Advisory Complement (RAT)	<input type="text"/>	Multiple Threat Encounter (MTE)	<input type="text"/>

DF17 Test Results Screen

3:07 PM Thu Mar 17 74%

Back BDS 0.5 BDS 0.6 BDS 0.8 BDS 0.9 BDS 6.1 BDS 6.2 BDS 6.5

Transponder Capability (CA)	<input type="text"/>	Address Announced (AA)	<input type="text"/>
Parity/Interrogator Identity (PI)	<input type="text"/>	Type Code	<input type="text"/>
Surveillance Status (SS)	<input type="text"/>	Altitude (Baro)	<input type="text"/>
Time (T)	<input type="text"/>	CPR Format (F)	<input type="text"/>
Airborne Latitude	<input type="text"/>	Airborne Longitude	<input type="text"/>
NIC	<input type="text"/>		

DF20 Test Results Screen

The screenshot shows a mobile application interface for DF20 test results. At the top, there is a blue header bar with the time '3:07 PM Thu Mar 17' on the left, a 'Back' button, and a menu of BDS options (BDS 0.7, BDS 1.0, BDS 1.7, BDS 2.0, BDS 2.1, BDS 3.0, BDS 4.0, BDS 4.8, BDS 5.0, BDS 5.1, BDS 5.2) with 'BDS 0.7' selected. On the right of the header, there is a signal strength icon and a battery icon showing 74%. Below the header, the screen is divided into several sections, each containing a label and a corresponding input field:

Flight Status (FS)	<input type="text"/>	Downlink Request (DR)	<input type="text"/>
Interrogator Identify Subfield (IIS)	<input type="text"/>	Identifier Designator Subfield (IDS)	<input type="text"/>
Altitude Code (AC)	<input type="text"/>	Address Parity (AP)	<input type="text"/>
Message Status	<input type="text"/>		
Transmission Rate Subfield (TRS)	<input type="text"/>	Altitude Type Subfield (ATS)	<input type="text"/>

The bottom half of the screen is a large, empty light gray area, likely reserved for additional test data or logs. A home indicator bar is visible at the very bottom of the screen.

DF21 Test Results Screen

The screenshot shows a mobile application interface for DF21 test results. It has the same header as the DF20 screen, including the time '3:07 PM Thu Mar 17', a 'Back' button, and the same menu of BDS options with 'BDS 0.7' selected. The signal strength and battery (74%) icons are also present. The main content area contains the following fields:

Flight Status (FS)	<input type="text"/>	Downlink Request (DR)	<input type="text"/>
Interrogator Identify Subfield (IIS)	<input type="text"/>	Identifier Designator Subfield (IDS)	<input type="text"/>
Identification (ID)	<input type="text"/>	Address Parity (AP)	<input type="text"/>
Message Status	<input type="text"/>		
Transmission Rate Subfield (TRS)	<input type="text"/>	Altitude Type Subfield (ATS)	<input type="text"/>

Like the DF20 screen, the bottom half is a large, empty light gray area, and a home indicator bar is at the bottom.

SECTION 19: ADS-B OUT

SUBSECTION 1: ADS-B OUT OPERATION

WARNING

It is extremely dangerous to generate signals during testing that are on the frequencies that are in use by local ATC. When operating the test set in ADS-B Mode, please be aware of the local navigation aid and ATC frequencies. It is the test set operator's responsibility to make sure all testing is carried out on frequencies that will not interfere with local navigation aids or ATC resources.

Hardware Required

Item	Test Type	Description / Notes	Part Number
Pulse Antenna	Ant - Ant	Yellow flat plate Pulse antenna	123-0230
Tripod	Ant - Ant	Required to mount antenna.	118-2286
Coax Cable option of 6, 20 or 60 ft	Ant - Ant Dir - Cable	Ant-Ant Operator choice of length to allow satisfactory positioning of test antenna to achieve a clear line of site to the Aircraft antenna under test. Dir- Cbl – operator choice of length recommended to use shortest possible.	VARIOUS
Coupler	Ant - Coupler	Antenna Coupler See the Antenna Coupler Section of this document	123-0237

WARNING

All ARTS 7000 Mode S transponder testing is carried out in accordance with Far 43 Appendix F requirements. Please ensure that using the ARTS 7000 that you are aware of the specific requirements of FAR 43 Appendix F and any other local transponder testing requirements.

SUBSECTION 2: ADS-B OUT TEST GUIDE

WARNING

It is extremely dangerous to generate signals during testing that are on the frequencies that are in use by local ATC. When operating the test set in ADS-B Mode. Please be aware of the local navigation aid and ATC frequencies. It is the test set operator's responsibility to make sure all testing is carried out so there is no effect on other aircraft or ATC resources.

Hints and Tips

When testing transponders, if Power failures are identified it is recommended to move the test antenna slightly in the horizontal plane and retest the transponder.

1. Antenna alignment is critical to successful testing of transponders. The ARTS 7000 pulse antenna is highly directional in both x- and y- planes and must be positioned in such a way that the center point of the antenna is pointed as accurately as possible to the aircraft antenna under test. Failure to get good alignment results in a higher likelihood of poor interrogations, reflections, and multi-path issues.



ARTS 7000 Pulse antenna showing good alignment with an aircraft bottom antenna.

Please see the section on Pulse Antenna Alignment, Reflections, and Multipath.

2. To achieve good ADSB tests, it is critical that the aircraft is in the correct status (i.e. in "Air mode"). Additionally other systems may need to be operation for the Transponder to squitter data. For example, GPS position will only be available if the aircraft has valid GPS signals.

ADS-B Out Test Selection

1. From the Main Menu select **Test Functions**.
2. From the Test Functions menu select **ATC**.
3. From the ATC menu select **ADS-B**
4. From the ADS-B Menu Select **ADS-B Out**.
5. The relevant ADS-B Out test Screen is now displayed.

ADS-B Out Test Configuration

Before running the Test, operators can access the configuration page via the CONFIG button to establish the user preferences. The ARTS 7000 will store the last configuration used.

ADS-B Out Test Configuration Screen

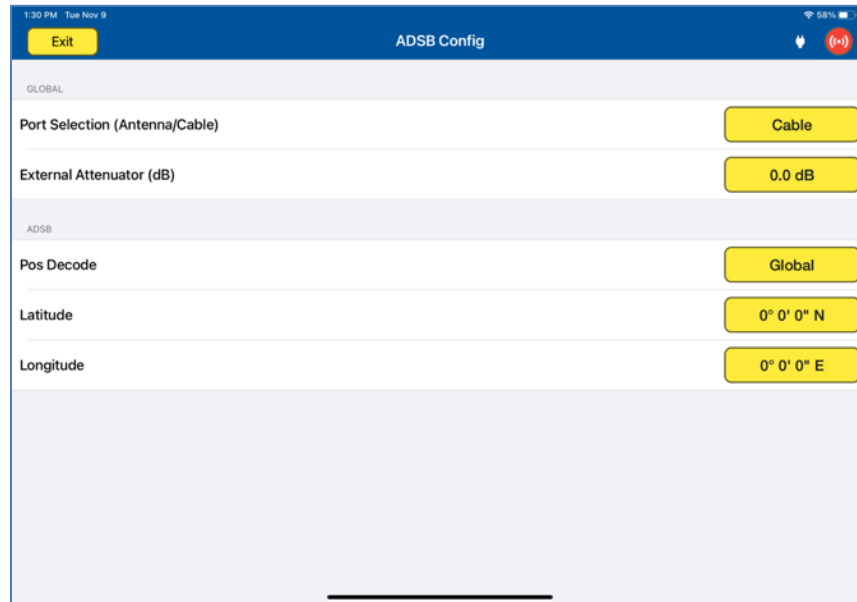

ADS-B Out Test Configuration Controls and Selections

Item	Description
Port Selection (Cable/Antenna)	Selects the over the air (Antenna port) or the Direct (Cable port) connection or Cable w/Coupler (Cable port)
External Attenuator	If an external attenuator is used between the ARTS 7000 and the unit under test – sets the value of the attenuator (Cable port only)
Pos Decode	Position decode either local or global
Latitude	Current Latitude if known – Can pull from iPad or from ARTS when signal is available.
Longitude	Current Longitude if known - Can pull from iPad or from ARTS when signal is available.

ADS-B Out Test Screen

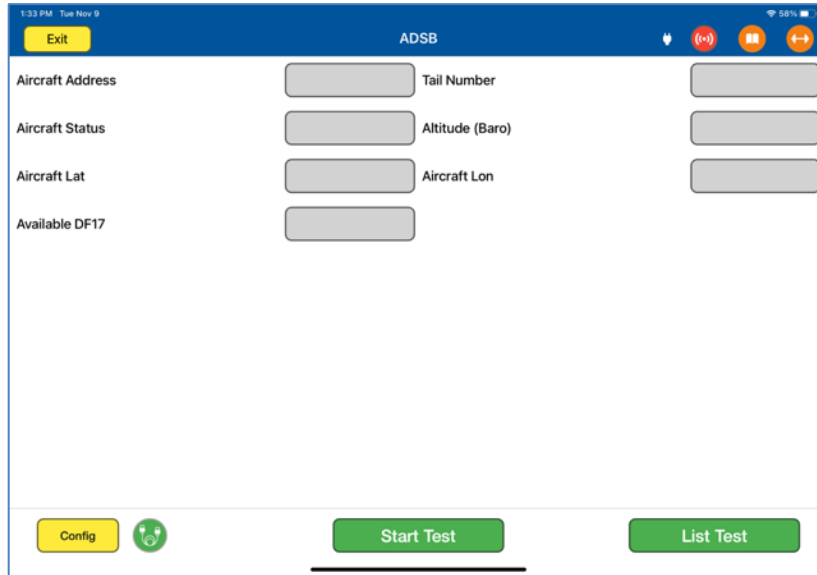

The screenshot shows a mobile application interface for testing ADS-B Out. The top bar is blue with an 'Exit' button on the left and the title 'ADSB' in the center. Below the title bar are several input fields arranged in two columns: Aircraft Address, Tail Number, Aircraft Status, Altitude (Baro), Aircraft Lat, Aircraft Lon, and Available DF17. At the bottom of the screen, there are three buttons: 'Config' (yellow), 'Start Test' (green), and 'List Test' (green). The status bar at the top shows the time as 1:33 PM, the date as Tue Nov 9, and a battery level of 55%.

ADS-B Out Test Indications



Item	Description
Aircraft Address	ADS-B Squittered – Aircraft Address
Tail Number	ADS-B Squittered – Aircraft Tail number
Aircraft Status	ADS-B Squittered – Current configuration of the aircraft under test
Altitude (Baro)	ADS-B Squittered – Barometric altitude of the aircraft
Aircraft Lat	ADS-B Squittered – Current latitude position of the aircraft
Aircraft Lon	ADS-B Squittered – Current longitude position of the aircraft
Available DF17	Confirmation of availability of DF 17

Test Selections

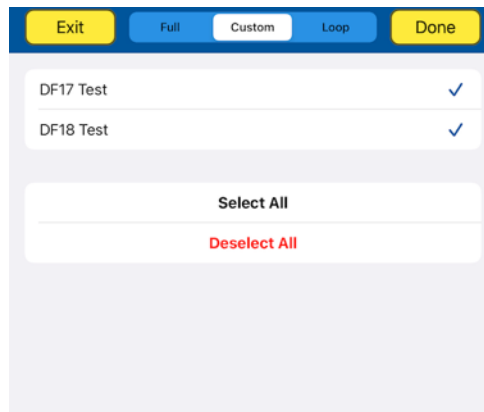
When the test is run the operator has several options presented on a pop up. This determines the type of ADS-B test run.

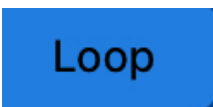

Test Selection pop-up screen

Test Name	Description
	The Full test exercises all parameters of the transponder reply. This test is carried out in accordance with the requirements of FAR 43 Appendix F.
	The CUSTOM Test allows the operator to specify which tests are to be performed. Selections are indicated with a checkmark. This test does <u>not</u> meet the specific requirements of Far 43 Appendix F.
	The LOOP Test allows the operator to specify which tests are to be performed. The test will loop through the selected tests. This test does <u>not</u> meet the specific requirements of Far 43 Appendix F.

SUBSECTION 3: ADS-B OUT RESULTS SCREEN

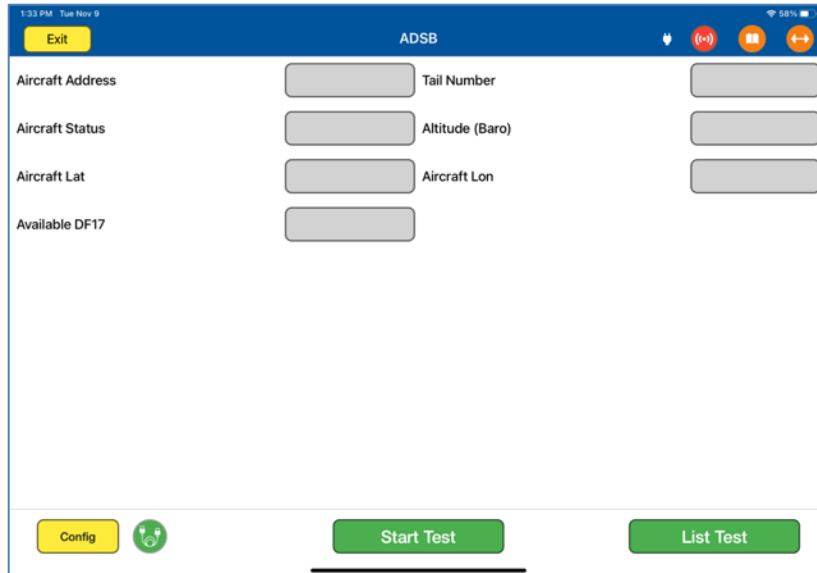

The screenshot shows a mobile application interface for ADS-B testing. At the top, there is a blue header with the title "ADSB" and an "Exit" button. Below the header, there are several input fields for data entry: "Aircraft Address", "Tail Number", "Aircraft Status", "Altitude (Baro)", "Aircraft Lat", "Aircraft Lon", and "Available DF17". At the bottom of the screen, there are three buttons: "Config", "Start Test", and "List Test".

1. Above is the main test screen for ADS-B. During the test and after the test is complete, the fields indicated will display the relevant data.
2. Once the test is complete the ARTS 7000 stores the results that can be viewed and downloaded from the **UTILITIES>RECORDS** menu.
3. Test Results shown in GREEN have passed the specification those shown in RED have failed.
4. When the test is completed, pressing the **LIST TEST** button this will launch the screen below.

List Test Screen

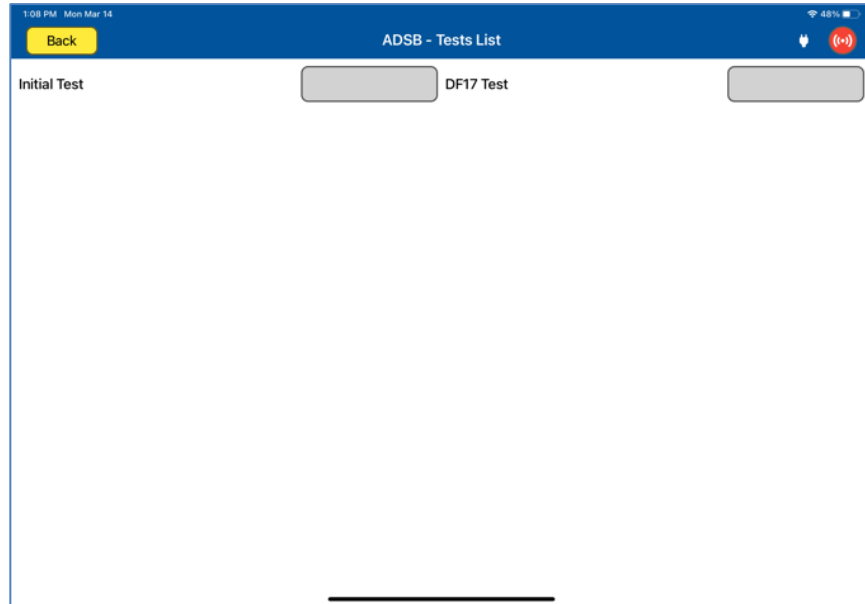

Select any of the results fields to review the specific modules test results.

Test Results Screen Details

Item	Description of module contents
Initial Test	This links back to the basic test results screen
DF17	ADS-B specific data transmitted in the aircraft reply stored within DF17. All Associated BDS registers data is available through the DF17 test result screen.

Examples of ADS-B Out Module Test Results (Example data)

Note: Where available, the relevant BDS registers are accessed through the title bar of the results screen.

DF17 Test Results Screen

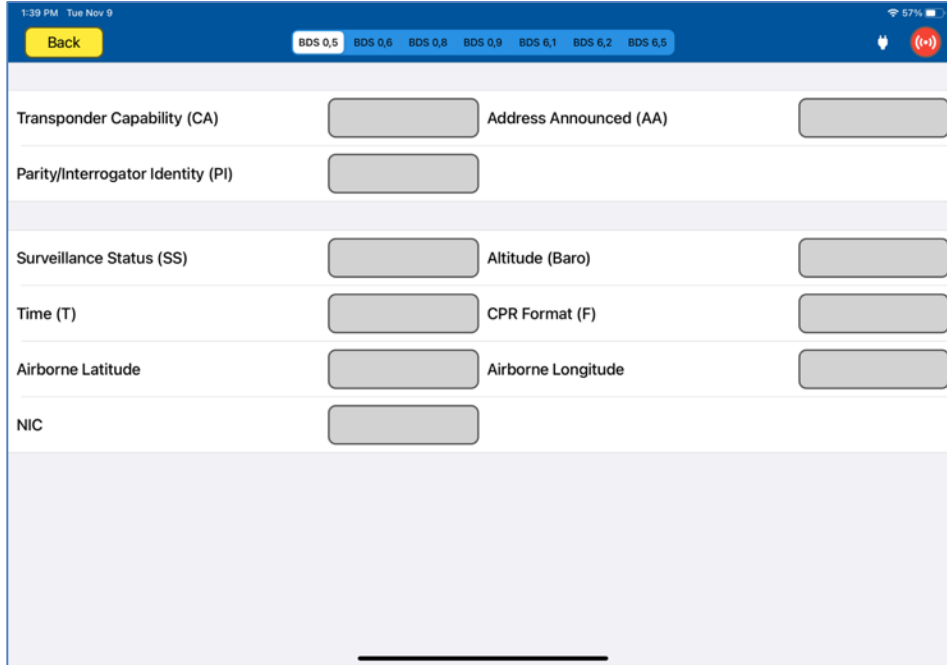

Parameter	Value
Transponder Capability (CA)	
Address Announced (AA)	
Parity/Interrogator Identity (PI)	
Surveillance Status (SS)	
Altitude (Baro)	
Time (T)	
CPR Format (F)	
Airborne Latitude	
Airborne Longitude	
NIC	

SECTION 20: ADS-B IN

SUBSECTION 1: ADS-B IN OPERATION

WARNING

It is extremely dangerous to generate signals during testing that are on the frequencies that are in use by local ATC. When operating the test set in ADS-B Mode, please be aware of the local navigation aid and ATC frequencies. It is the test set operator's responsibility to make sure all testing is carried out on frequencies that will not interfere with local navigation aids or ATC resources.

Hardware Required

Item	Test Type	Description / Notes	Part Number
Pulse Antenna	Ant – Ant	Yellow flat plate Pulse antenna	123-0230
Tripod	Ant – Ant	Required to mount antenna.	118-2286
Coax Cable option of 6, 20 or 60 ft	Ant – Ant Dir – Cable	Ant-Ant Operator choice of length to allow satisfactory positioning of test antenna to achieve a clear line of site to the Aircraft antenna under test. Dir- Cbl – operator choice of length recommended to use shortest possible.	VARIOUS
Coupler	Ant – Coupler	Antenna Coupler See the Antenna Coupler Section of this document	123-0237

WARNING

All ARTS 7000 Mode S transponder testing is carried out in accordance with Far 43 Appendix F requirements. Please ensure that using the ARTS 7000 that you are aware of the specific requirements of FAR 43 Appendix F and any other local transponder testing requirements.

SUBSECTION 2: ADS-B IN TEST GUIDE

WARNING

It is extremely dangerous to generate signals during testing that are on the frequencies that are in use by local ATC. When operating the test set in ADS-B Mode, please be aware of the local navigation aid and ATC frequencies. It is the test set operator's responsibility to make sure all testing is carried out so there is no effect on other aircraft or ATC resources.

Hints and Tips

When testing transponders, if Power failures are identified it is recommended to move the test antenna slightly in the horizontal plane and retest the transponder.

1. Antenna alignment is critical to successful testing of transponders. The ARTS 7000 pulse antenna is highly directional in both x- and y- planes and must be positioned in such a way that the center point of the antenna is pointed as accurately as possible to the aircraft antenna under test. Failure to get good alignment results in a higher likelihood of poor interrogations, reflections, and multi-path issues.



ARTS 7000 Pulse antenna showing good alignment with an aircraft bottom antenna.

Please see the section on Pulse Antenna Alignment, Reflections, and Multipath.

2. To achieve good ADS-B tests, it is critical that the aircraft is in the correct status (i.e. in "Air mode"). Additionally other systems may need to be operation for the Transponder to squitter data. For example, GPS position will only be available if the aircraft has valid GPS signals.

ADS-B In Test Selection

1. From the Main Menu select **Test Functions**.
2. From the Test Functions menu select **ATC**.
3. From the ATC menu select **ADS-B**
4. From the ADS-B Menu Select **ADS-B In**.
5. The relevant ADS-B In test Screen is now displayed.

ADS-B In Test Configuration

Before running the Test, operators can access the configuration page via the CONFIG button to establish the user preferences. The ARTS 7000 will store the last configuration used.

ADS-B In Test Configuration Screen

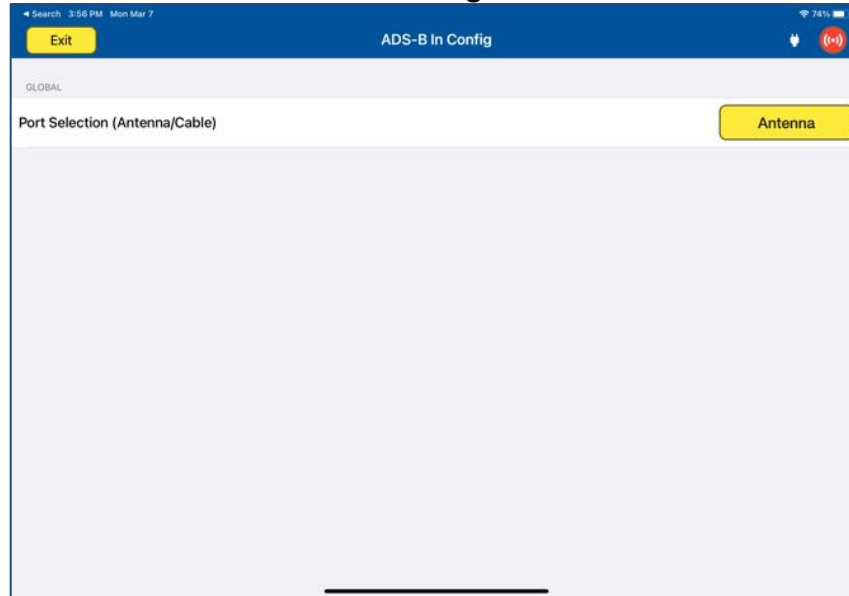

ADS-B In Test Configuration Controls and Selections

Item	Description
Port Selection (Cable/Antenna)	Selects the over the air (Antenna port) or the Direct (Cable port) connection or Cable w/Coupler (Cable port)

ADS-B In Test Screen

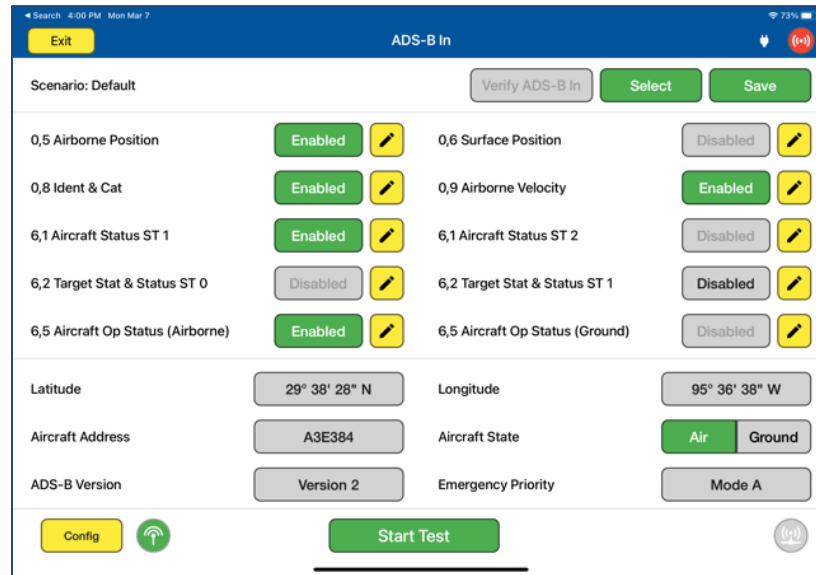

ADS-B In Test Indications

Item	Description
Scenario	Pre-defined ADS-B In scenario for user to select. User can also save specific scenarios created on the Test Screen for future use.
0,5 Airborne Position	Configure BDS register for airborne position of ADS-B In simulated target, including Altitude, Surveillance Status, and Time.
0,6 Surface Position	Configure BDS register for surface position of ADS-B In simulated target, including Speed, Heading, and Time.
0,8 Ident & Cat	Configure BDS register for Flight ID & category of ADS-B In simulated target, including Flight ID, Emitter Category Type, and Emitter Category.
0,9 Airborne Velocity	Configure BDS register for airborne velocity of ADS-B In simulated target, including Subtype, NACv, East/West, North/South velocity, Source, Vertical rate, and Geo/Pressure difference.
6,1 Aircraft Status ST 1	Configure BDS register for aircraft emergency status of ADS-B In simulated target, including Emergency priority status, and Mode A code.
6,1 Aircraft Status ST 2	Configure BDS register for aircraft emergency status of ADS-B In simulated target, including ARA, RAC, RAT, MTE, TTI, and Mode S address of threat.

6,2 Target Stat & Status ST 0	Configure BDS register for aircraft target status of ADS-B In simulated target, including vertical, horizontal, and positional data.
6,2 Target Stat & Status ST 1	Configure BDS register for aircraft target status of ADS-B In simulated target, including altitude, positional, and supplemental data.
6,5 Aircraft Op Status (Airborne)	Configure BDS register for airborne aircraft operational status of ADS-B In simulated target.
6,5 Aircraft Op Status (Ground)	Configure BDS register for grounded aircraft operational status of ADS-B In simulated target.
Latitude	Set Latitude coordinates of Aircraft under test. Can use pre-set GPS coordinates from the iPad or ARTS unit when available.
Longitude	Set Longitude coordinates of Aircraft under test. Can use pre-set GPS coordinates from the iPad or ARTS unit when available.
Aircraft Address	Set Address of ADS-B target.
Aircraft State	Set State of ADS-B target – Air or Ground.
ADS-B Version	Set Version of ADS-B target – Version 1 or Version 2
Emergency Priority	Set source of emergency priority information – Mode A or Resolution Advisory.
NIC Airborne	Airborne Navigation Integrity category. Set the airborne location precision of the ADS-B target.
NIC Surface	Surface Navigation Integrity category. Set the surface location precision of the ADS-B target.
Power	Set output power of ARTS transmission at connector port.

ADS-B In Test Operation

Using the inputs above, operators have full control of BDS registers and aircraft settings to simulate a particular type of ADS-B In target. The operator should confirm the correct target is recognized on their ADS-B unit corresponding to the ARTS 7000 simulated target.

SECTION 21: ATCRBS TRANSPONDERS

Subsection 1: ATCRBS Operation

WARNING

It is extremely dangerous to generate signals during testing that are on the frequencies that are in use by local ATC. When operating the test set in ATCRBS Mode, please be aware of the local navigation aid and ATC frequencies. It is the test set operator's responsibility to make sure all testing is carried out on frequencies that will not interfere with local navigation aids or ATC resources.

Hardware Required

Item	Test Type	Description / Notes	Part Number
Pulse Antenna	Ant - Ant	Yellow flat plate Pulse antenna	123-0230
Tripod	Ant - Ant	Required to mount antenna.	118-2286
Coax Cable option of 6, 20 or 60 ft	Ant - Ant Dir - Cable	Ant-Ant Operator choice of length to allow satisfactory positioning of test antenna to achieve a clear line of site to the Aircraft antenna under test. Dir-Cbl – operator choice of length recommended to use shortest possible.	VARIOUS
Coupler	Ant - Coupler	Antenna Coupler See the Antenna Coupler Section of this document	123-0237

ATCRBS test – Different Test options

There are several ATCRBS tests that the ARTS 7000 can complete. All tests operate similarly but with differing levels of performance. It is the operator's choice as to which tests are applicable. From the ATCRBS top-level menu, specific tests can be selected. All ATCRBS tests break out the specific parameters of the ATCRBS reply. This enables the operator to understand and review the results quickly.

The options and descriptions of each test type are below:

Test Name	Description
Generic ATCRBS	The Generic ATCRBS test is a full capability test of all parameters of the transponder reply. Tests can be Full (FAR43 Appendix F), Custom or looped
ATCRBS - Class A	The ATCRBS Class A (Full) is only applicable to a Class A transponder specific limits as identified in Far 43 Appendix F Tests can be Full (FAR43 Appendix F), Custom or looped

Mode S Class B	The Generic ATRBS Class B (Full) is only applicable to a Class B transponder as identified in Far 43 Appendix F Tests can be Full (FAR43 Appendix F), Custom or looped
----------------	--

SUBSECTION 2: ATRBS TEST GUIDE

WARNING

It is extremely dangerous to generate signals during testing that are on the frequencies that are in use by local ATC. When operating the test set in ATRBS Mode, please be aware of the local navigation aid and ATC frequencies. It is the test set operator's responsibility to make sure all testing is carried out on frequencies that will not interfere with local navigation aids or ATC resources.

WARNING

Testing Top antenna often requires the use of gantries and/ or high-level platforms. This is because it is essential to get a to get a good line of sight on the top antenna. It is advised to use caution in these circumstances and make sure the operator ensures their safety and that of others. Please ensure the antenna is secured safely and cannot easily fall.

WARNING

Please be aware of putting an aircraft to a test altitude. Under this circumstance when the ATRBS is On and the aircraft system is at an altitude the aircraft under test will trigger TCAS advisories and

Hints and Tips

When testing any Transponders, DME or TCAS make sure the reflective paths are minimized from equipment that is in close proximity to the aircraft. Try to select a line of site between the test Set antenna and the Aircraft antenna that does not have any obstruction in front or behind the antenna being tested. For example: Ground Power Units, Aircraft Landing Gear, Aircraft Stairs, Toolboxes etc.

Hints and Tips

When Testing transponders - If Power failures are identified it is recommended to move the test antenna slightly in the horizontal plane and test the transponder again.

Antenna alignment is critical to successful testing of transponders. The ARTS 7000 pulse antenna is highly directional in both x and y planes and must be positioned in such a way that the center point of the antenna is pointed as accurately as possible to the aircraft antenna under test.

Failure to get good alignment causes a chance of poor interrogations, reflections, and multi-path issues.



ARTS 7000 Pulse antenna showing good alignment with an aircraft bottom antenna.

Please see the section on Pulse Antenna Alignment, Reflections and Multipaths.

Transponder testing may take > 20 minutes depending on the capability of the transponder. It is recommended to choose the basic test first. Once the basic test is completed successfully, the full test can be run.

It is good practice to screen the antenna not under test using a suitable Antenna screen. Contact Laversab for details.

Using an antenna coupler is highly recommended to reduce radiation of the interrogation and reply signals. Please contact Laversab for details.

To achieve good transponder tests, it is critical that they aircraft is in the correct status (i.e. in "Air mode"). Additionally other systems may need to be operation for the Transponder to squitter data. For example, GPS position will only be available if the aircraft has valid GPS signals.

WARNING

All ARTS 7000 ATCRBS transponder testing is carried out in accordance with Far 43 Appendix F requirements. Please ensure that using the ARTS 7000 that you are aware of the specific requirements of FAR 43 Appendix F and any other local transponder testing requirements.

WARNING

Testing Top antenna often requires the use of gantries and/ or high-level platforms. This is because it is essential to get a to get a good line of sight on the top antenna. It is advised to

use caution in these circumstances and make sure the operator ensures their safety and those around him. Please ensure the antenna is secured safely and cannot easily fall.

WARNING

Please be aware of putting an aircraft to a test altitude. Under this circumstance when the Transponder is On and the aircraft system is at an altitude the aircraft under test will trigger TCAS advisories and other aircraft may experience false TCAS advisories.

This situation is very dangerous and may be subject to legal or financial actions.

Hints and Tips

When testing any Transponder, DME, or TCAS, ensure the reflective paths are minimized from equipment that is near the aircraft. Try to select a line of sight between the ARTS antenna and the Aircraft antenna that does not have any obstruction in front or behind them. For example: Ground Power Units, Aircraft Landing Gear, Aircraft Stairs, Toolboxes etc.

Hints and Tips

When testing transponders, if Power failures are identified it is recommended to move the test antenna slightly in the horizontal plane and retest the transponder.

ATCRBS Test Selection

1. From the Main Menu Select **Test Functions**.
2. From the Functions menu select **ATC**.
3. From the ATC Menu select **ATCRBS**.
4. From the ATCRBS menu select which ATCRBS Test is required – see table above.
5. The relevant ATCRBS Test Screen is now displayed.

ATCRBS Test Configuration

Before running the Test, operators can access the configuration page via the CONFIG button to establish the user preferences. The ARTS 7000 will store the last configuration used.

ATCRBS Test Configuration Screen

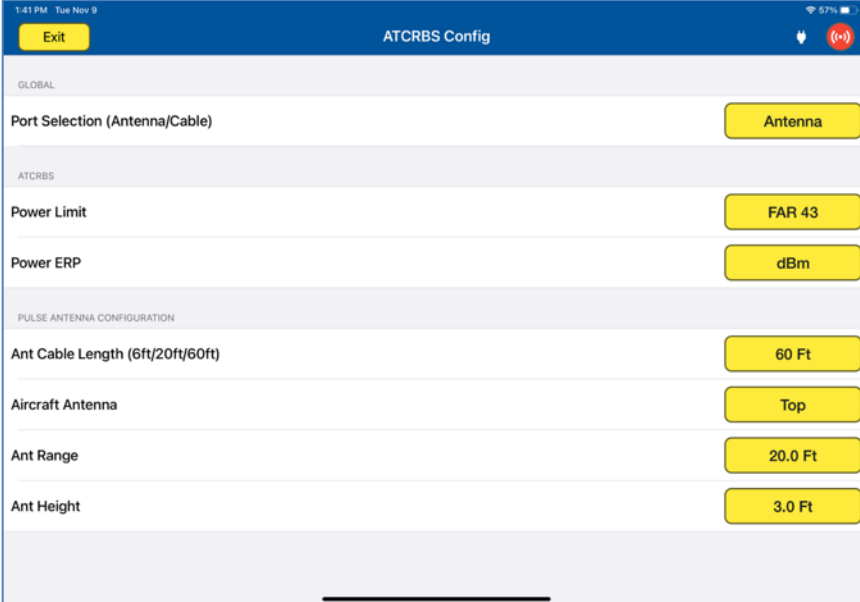

Section	Item	Selection
GLOBAL	Port Selection (Antenna/Cable)	Antenna
ATCRBS	Power Limit	FAR 43
	Power ERP	dBm
PULSE ANTENNA CONFIGURATION	Ant Cable Length (6ft/20ft/60ft)	60 Ft
	Aircraft Antenna	Top
	Ant Range	20.0 Ft
	Ant Height	3.0 Ft

ATCRBS Test Configuration Controls and Selections

Item	Description
Port Selection (Cable/Antenna)	Selects the over the air (Antenna port) or the Direct (Cable port) connection or Cable w/Coupler (Cable port)
External Attenuator value	When an attenuator is used the value of the attenuator should be entered in this field (Cable port only)
Power Limit	Can either be set to FAR 43 specification or unlimited. Recommend using the FAR 43 specification.
Power ERP	Selection of power measurement - The ARTS 7000 can measure ERP in Watts or dBm
Ant Cable Length (6, 20 or 60 ft)	When testing ATCRBS over the air or antenna to antenna – this field is used to identify which length of coax cable that is being used between the ARTS 7000 connector and the ARTS 7000 Pulse antenna- this is used to calculate the loss in the cable.
Aircraft Antenna	Top or Bottom Antenna if diversity is available on aircraft.
Ant Range	Horizontal distance from the ARTS 7000 antenna to the aircraft's antenna entered in feet. Does not have to be 100% accurate.
Ant Height	Vertical height from the ARTS 7000 antenna to the aircraft antenna entered in feet. Does not have to be 100% accurate.

Direct Cable Length (6, 20 or 60 ft) <i>(Not Shown above)</i>	When testing ATCRBS over a direct/cable connection – this field is used to identify which length of coax cable that is being used between the ARTS 7000 connector and the aircraft units' antenna feeder or antenna connector. this is used to calculate the loss in the cable.
Coupler Loss (dB)	Predetermined typical loss through Coupler. The value should be listed on the coupler itself.

ATCRBS Test Screen



ATCRBS Test Controls and Selections

Item	Description
RX Frequency	In test indication of the ARTS 7000 received frequency from the Aircraft transponder's reply.
Replies	In test indication of the number of replies received from the aircraft related to the number of interrogations sent to the aircraft in %
ERP	In test indication of the power of the Aircraft transponder's reply from the selected aircraft antenna



MTL	In test indication of the transponders Minimum Trigger Level from the selected aircraft antenna
A Code	In test indication of the Mode A code
Mode C Altitude	In test indication of the Mode C altitude

Test Selections

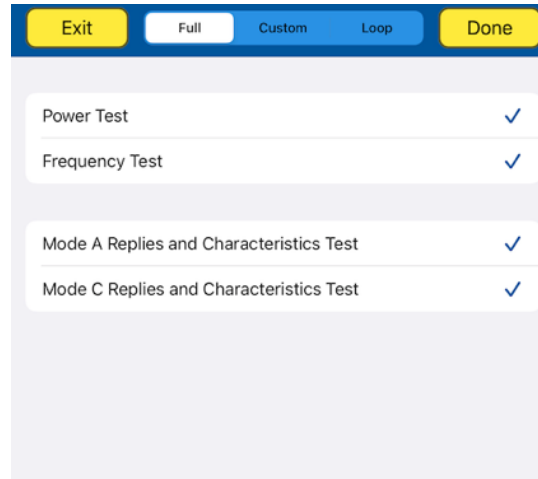
When the test is run the operator has several options presented on a pop up. This determines the type of ATCRBS test run.



Test Selection pop up screen.

Test Name	Description
	The Full test is a full capability test of all parameters of the transponder reply. This test is carried out in accordance with the requirements of FAR 43 Appendix F.
	The CUSTOM Test allows the operator to select at a modular level which tests are to be completed. 1 to n tests may be selected and run as required. This test does not meet the specific requirements of Far 43 Appendix F. Select the required tests by selecting the associated tick icon.
	The LOOP Tests allow the operator to select which module or modules are required to be tested. The test will then continually loop only the selected test. This test does not meet the specific requirements of Far 43 Appendix F.

Antenna Alignment Tool.

Used for Antenna-to-Antenna connection only.

When the test is started, the ARTS 7000 Application will automatically launch the Antenna Alignment tool. This tool can ensure the best possible Antenna alignment before the test starts.

The tool displays live updated Transponder % replies and ERP. While the tool is running the operator can adjust the antenna position to ensure the highest possible returned values to ensure the best quality over-the-air connection to the aircraft.

The tool also displays the Antenna Range and the Antenna Height to the Antenna selected in the Config (Top/Bottom). During alignment, these values can be adjusted to get an optimal signal.

Once the % replies and the ERP are sufficient, the test can be started.

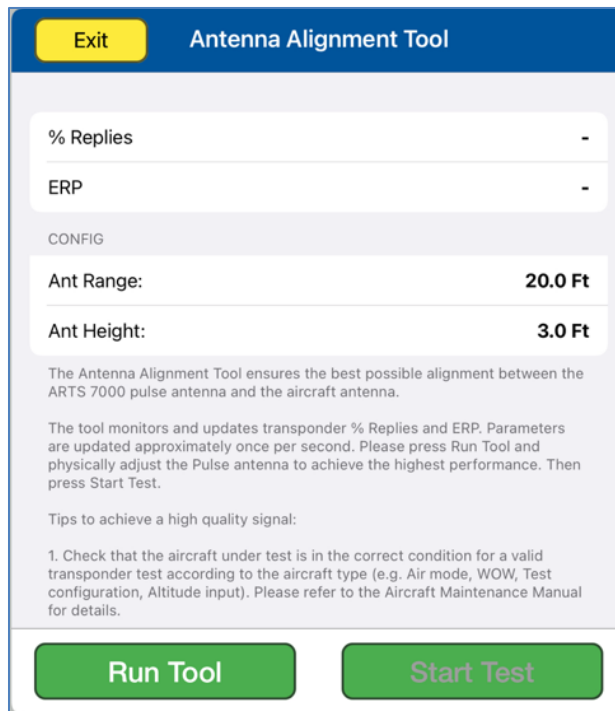

The screenshot shows the 'Antenna Alignment Tool' interface. At the top left is a yellow 'Exit' button. The title 'Antenna Alignment Tool' is centered at the top. Below the title, there are two rows of data: '% Replies' and 'ERP', both showing a dash '-' as their value. Underneath is a 'CONFIG' section with two rows: 'Ant Range:' set to '20.0 Ft' and 'Ant Height:' set to '3.0 Ft'. Below the config section is a paragraph of text explaining the tool's purpose and how to use it. This is followed by a section titled 'Tips to achieve a high quality signal:' with a numbered list containing one tip. At the bottom of the interface are two green buttons: 'Run Tool' on the left and 'Start Test' on the right.

Antenna Alignment tool

SUBSECTION 3: ATCRBS RESULTS SCREEN

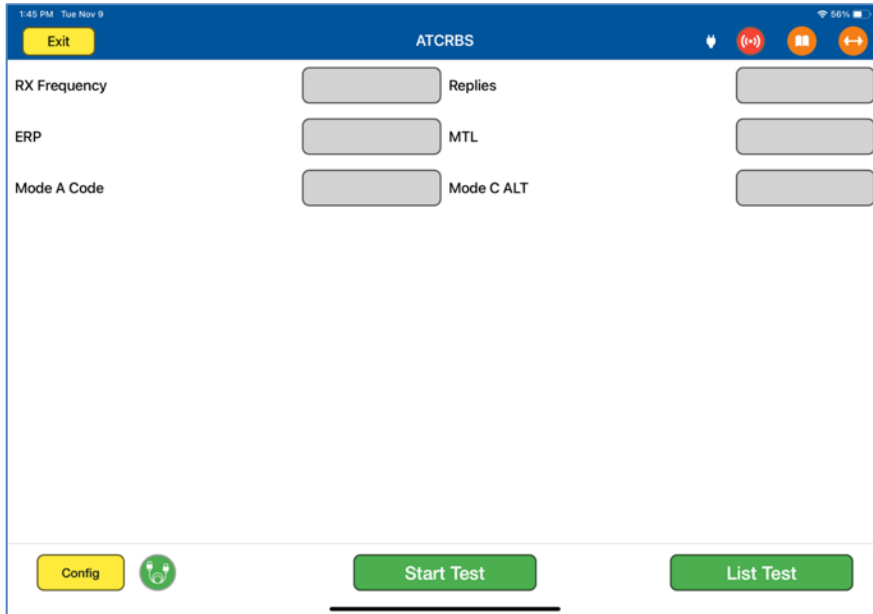

1. Above is the main test screen for ATCRBS. During the test and after the test is complete the fields indicated will display the relevant data.
2. Once the test is complete the ARTS 7000 stores the results that can be viewed and downloaded from the **Utilities>Records** menu.
3. Test Results shown in Green have passed the specification those shown in red have failed.
4. When the test is completed, pressing the **LIST TEST** button this will launch the screen below.

Note: depending on which version of test that was completed there are slightly different test results screens. The item below is for the full ATCRBS test.

List Test Screen

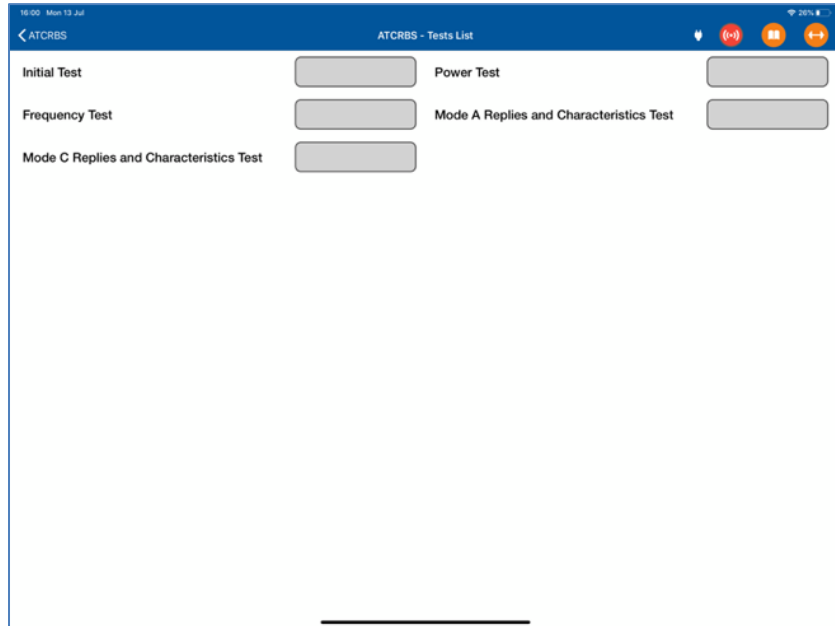

Select any of the results fields to review the specific modules test results.

Item	Description of module contents
Initial Test	This links back to the basic test results screen
Power	ERP and MTL levels received from the Transponder under test replies.
Frequency Test	Indicates the Frequency of the MODE S and ATCRBS replies from the Aircraft.
Mode A Reply and characteristics	Mode A specific characteristics including pulse and pulse spacing measurement, low and high limit responses.
Mode C Reply and characteristics	Mode C specific characteristics including pulse and pulse spacing measurement, low and high limit responses.

Test Results Screen Details

Screen shots of ATCRBS Module Test Results (Example data)

Power Test Results Screen

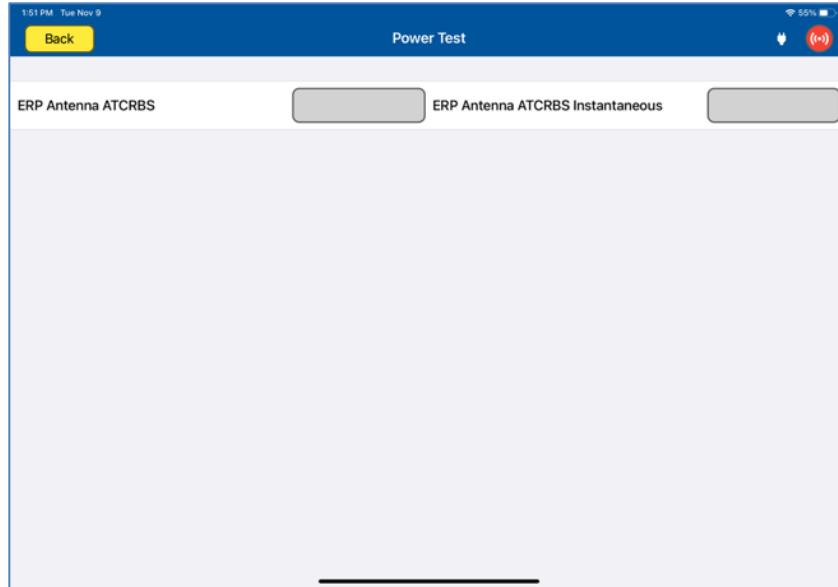

Frequency Test Results Screen

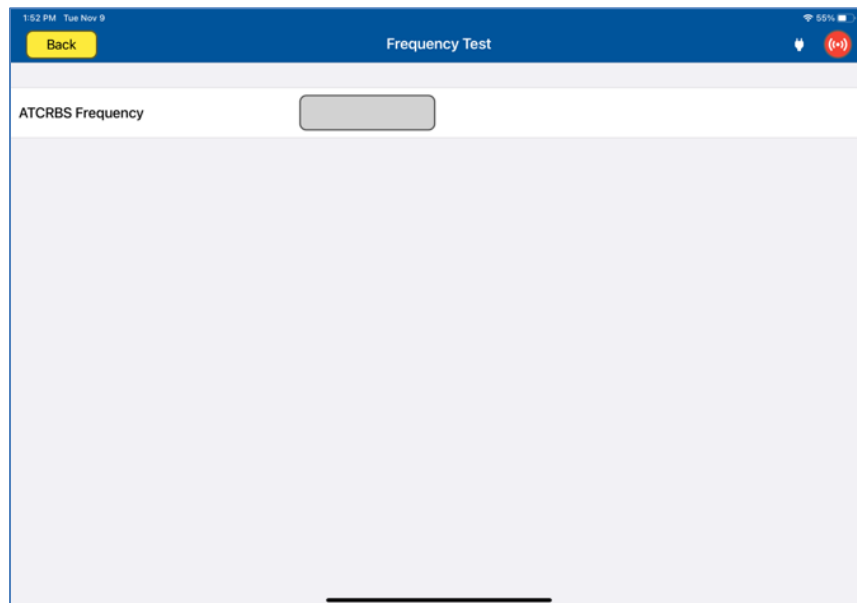

Mode A Replies and Characteristics Test Results Screen

The screenshot shows a mobile application interface for testing Mode A replies. The title bar is blue with a 'Back' button on the left and a signal strength indicator on the right. The main content area has a white background with a light blue header. It contains several rows of test parameters, each with a label and a corresponding input field:

- ATCRBS All Call (input field)
- Mode A Squawk Code (input field)
- Mode A Ident (input field)
- Mode A Code Binary (input field)
- High Ratio of Replies Mode A (input field)
- Low Ratio of Replies Mode A (input field)
- High Limit Mode A Must Reply (input field)
- Low Limit Mode A Must Reply (input field)
- High Limit Mode A Must Not Reply (input field)
- Low Limit Mode A Must Not Reply (input field)
- Mode A SLS -9dB (input field)
- Mode A SLS 0dB (input field)
- F1 Width Mode A (input field)
- F2 Width Mode A (input field)
- F1 to F2 Spacing Mode A (input field)

Mode C Replies and Characteristics Test Results Screen

The screenshot shows a mobile application interface for testing Mode C replies. The title bar is blue with a 'Back' button on the left and a signal strength indicator on the right. The main content area has a white background with a light blue header. It contains several rows of test parameters, each with a label and a corresponding input field:

- ATCRBS All Call (input field)
- Mode C Altitude (input field)
- Mode C Binary (input field)
- High Ratio of Replies Mode C (input field)
- Low Ratio of Replies Mode C (input field)
- High Limit Mode C Must Reply (input field)
- Low Limit Mode C Must Reply (input field)
- High Limit Mode C Must Not Reply (input field)
- Low Limit Mode C Must Not Reply (input field)
- Mode C SLS -9dB (input field)
- Mode C SLS 0dB (input field)
- F1 Width Mode C (input field)
- F2 Width Mode C (input field)
- F1 to F2 Spacing Mode C (input field)

SECTION 22: UAT

SUBSECTION 1: ACTIVATING UAT

Please refer to Appendix D: License Activation Procedure if UAT license is not already activated.

SUBSECTION 2: UAT OPERATION

UAT is an optional capability. It can be used with aircraft equipped with a UAT transponder. The ARTS can perform multiple UAT-based tests, including ADS-B In, ADS-B Out, FIS-B, and TIS-B.

WARNING

It is extremely dangerous to generate signals during testing that are on the frequencies that are in use by local ATC. When operating the test set in UAT Mode, please be aware of the local navigation aid and ATC frequencies. It is the test set operator's responsibility to make sure all testing is carried out on frequencies that will not interfere with local navigation aids or ATC resources.

Hardware Required

Item	Test Type	Description / Notes	Part Number
Pulse Antenna	Ant - Ant	Yellow flat plate Pulse antenna	123-0230
Tripod	Ant - Ant	Required to mount antenna.	118-2286
Coax Cable option of 6, 20 or 60 ft	Ant - Ant Dir - Cable	Ant-Ant Operator choice of length to allow satisfactory positioning of test antenna to achieve a clear line of site to the Aircraft antenna under test. Dir-Cbl – operator choice of length recommended to use shortest possible.	VARIOUS

SUBSECTION 3: UAT ADS-B OUT TEST GUIDE

WARNING

It is extremely dangerous to generate signals during testing that are on the frequencies that are in use by local ATC. When operating the test set in UAT ADS-B Mode. Please be aware of the local navigation aid and ATC frequencies. It is the test set operator's responsibility to make sure all testing is carried out so there is no effect on other aircraft or ATC resources.

Hints and Tips

When testing transponders, if Power failures are identified it is recommended to move the test antenna slightly in the horizontal plane and retest the transponder.

1. Antenna alignment is critical to successful testing of transponders. The ARTS 7000 pulse antenna is highly directional in both x- and y- planes and must be positioned in such a way that the center point of the antenna is pointed as accurately as possible to the aircraft antenna under test. Failure to get good alignment results in a higher likelihood of poor interrogations, reflections, and multi-path issues.



ARTS 7000 Pulse antenna showing good alignment with an aircraft bottom antenna.

Please see the section on Pulse Antenna Alignment, Reflections, and Multipath.

2. To achieve good ADSB tests, it is critical that the aircraft is in the correct status (i.e. in "Air mode"). Additionally other systems may need to be operation for the Transponder to squitter data. For example, GPS position will only be available if the aircraft has valid GPS signals.

UAT ADS-B Out Test Selection

1. From the Main Menu select **Test Functions**.
2. From the Test Functions menu select **ATC**.
3. From the ATC menu select **UAT**
4. From the UAT Menu Select **ADS-B Out**.
5. The relevant UAT ADS-B Out test Screen is now displayed.

UAT ADS-B Out Test Configuration

Before running the Test, operators can access the configuration page via the CONFIG button to establish the user preferences. The ARTS 7000 will store the last configuration used.

UAT ADS-B Out Test Configuration Screen

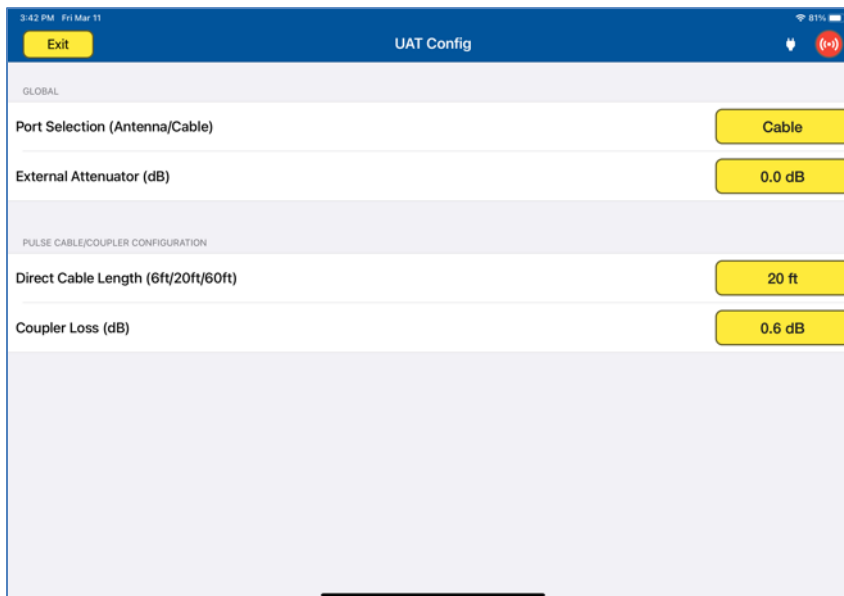

The screenshot shows the 'UAT Config' screen with the following settings:

- GLOBAL**
 - Port Selection (Antenna/Cable): Cable
 - External Attenuator (dB): 0.0 dB
- PULSE CABLE/COUPLER CONFIGURATION**
 - Direct Cable Length (6ft/20ft/60ft): 20 ft
 - Coupler Loss (dB): 0.6 dB

UAT ADS-B Out Test Configuration Controls and Selections

Item	Description
Port Selection (Cable/Antenna)	Selects the over the air (Antenna port) or the Direct (Cable port) connection
External Attenuator	If an external attenuator is used between the ARTS 7000 and the unit under test – sets the value of the attenuator (Cable port only)
Ant Cable Length (6, 20 or 60 ft) <i>(Not Shown above)</i>	When testing UAT over the air or antenna to antenna – this field is used to identify which length of coax cable that is being used between the ARTS 7000 connector and the ARTS 7000 Pulse antenna- this is used to calculate the loss in the cable.
Aircraft Antenna <i>(Not Shown above)</i>	Top or Bottom Antenna if diversity is available on aircraft.
Ant Range <i>(Not Shown above)</i>	Horizontal distance from the ARTS 7000 antenna to the aircraft's antenna entered in feet. Does not have to be 100% accurate.
Ant Height <i>(Not Shown above)</i>	Vertical height from the ARTS 7000 antenna to the aircraft antenna entered in feet. Does not have to be 100% accurate.
Direct Cable Length (6, 20 or 60 ft)	When testing UAT over a direct/cable connection – this field is used to identify which length of coax cable that is being used between the ARTS 7000 connector and the aircraft units' antenna feeder or antenna connector. this is used to calculate the loss in the cable.
Coupler Loss (dB)	Predetermined typical loss through Coupler. The value should be listed on the coupler itself.

UAT ADS-B Out Test Screen

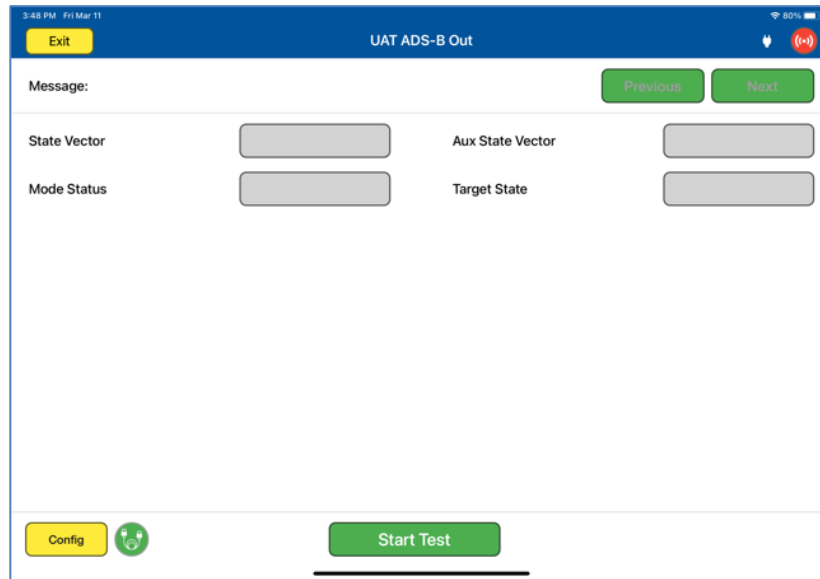

The screenshot shows a mobile application interface for testing ADS-B Out. The title bar is blue and contains 'UAT ADS-B Out'. The main area has a 'Message:' label and two green buttons: 'Previous' and 'Next'. Below this are four input fields arranged in two columns: 'State Vector', 'Aux State Vector', 'Mode Status', and 'Target State'. At the bottom, there is a yellow 'Config' button, a green circular icon with a plus sign, and a green 'Start Test' button.

UAT ADS-B Out Test Indications

Item	Description
Message	ADS-B message received from Aircraft under test. Depending on equipment class, multiple messages may be received.
	Toggle between ADS-B messages received from Aircraft under test.
State Vector	Position, horizontal velocity, and quality metrics of Aircraft under test. If available select to view details.
Aux State Vector	Secondary altitude of Aircraft under test per transponder settings. If available select to view details.
Mode Status	Status information (meter category, flight ID, or other) of the Aircraft under test. If available select to view details.
Target State	State information (selected altitude, barometric pressure, heading, other) of the Aircraft under test. If available select to view details.

SUBSECTION 4: UAT ADS-B IN TEST GUIDE

WARNING

It is extremely dangerous to generate signals during testing that are on the frequencies that are in use by local ATC. When operating the test set in UAT ADS-B Mode, please be aware of the local navigation aid and ATC frequencies. It is the test set operator's responsibility to make sure all testing is carried out so there is no effect on other aircraft or ATC resources.

Hints and Tips

When testing transponders, if power failures are identified it is recommended to move the test antenna slightly in the horizontal plane and retest the transponder.

1. Antenna alignment is critical to successful testing of transponders. The ARTS 7000 pulse antenna is highly directional in both x- and y- planes and must be positioned in such a way that the center point of the antenna is pointed as accurately as possible to the aircraft antenna under test. Failure to get good alignment increases the likelihood of poor transmissions, reflections, and multi-path issues.



ARTS 7000 Pulse antenna showing good alignment with an aircraft bottom antenna.

Please see the section on Pulse Antenna Alignment, Reflections, and Multipath.

2. To achieve good ADS-B tests, it is critical that the aircraft is in the correct status (i.e. in "Air mode"). Additionally other systems may need to be operation for the Transponder to squitter data. For example, GPS position will only be available if the aircraft has valid GPS signals.

UAT ADS-B In Test Selection

1. From the Main Menu select **Test Functions**.
2. From the Test Functions menu select **ATC**.
3. From the ATC menu select **UAT**
4. From the UAT Menu Select **ADS-B In**.
5. The relevant UAT ADS-B In test Screen is now displayed.

UAT ADS-B In Test Configuration

Before running the Test, operators can access the configuration page via the CONFIG button to establish the user preferences. The ARTS 7000 will store the last configuration used.

UAT ADS-B In Test Configuration Screen

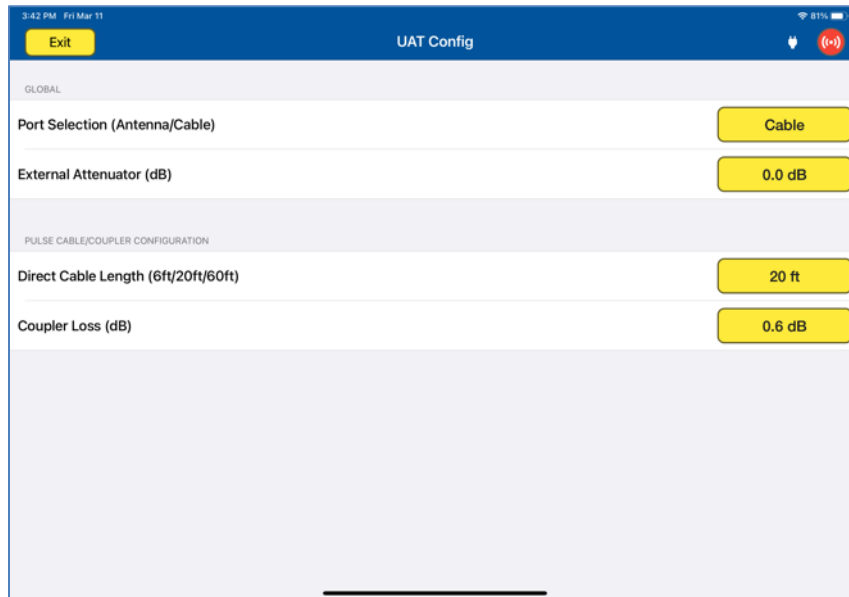

The screenshot shows the 'UAT Config' screen with the following settings:

- GLOBAL**
 - Port Selection (Antenna/Cable): Cable
 - External Attenuator (dB): 0.0 dB
- PULSE CABLE/COUPLER CONFIGURATION**
 - Direct Cable Length (6ft/20ft/60ft): 20 ft
 - Coupler Loss (dB): 0.6 dB

UAT ADS-B In Test Configuration Controls and Selections

Item	Description
Port Selection (Cable/Antenna)	Selects the over the air (Antenna port) or the Direct (Cable port) connection
External Attenuator	If an external attenuator is used between the ARTS 7000 and the unit under test – sets the value of the attenuator (Cable port only)
Ant Cable Length (6, 20 or 60 ft) <i>(Not Shown above)</i>	When testing UAT over the air or antenna to antenna – this field is used to identify which length of coax cable that is being used between the ARTS 7000 connector and the ARTS 7000 Pulse antenna- this is used to calculate the loss in the cable.
Aircraft Antenna <i>(Not Shown above)</i>	Top or Bottom Antenna if diversity is available on aircraft.
Ant Range <i>(Not Shown above)</i>	Horizontal distance from the ARTS 7000 antenna to the aircraft's antenna entered in feet. Does not have to be 100% accurate.

Ant Height <i>(Not Shown above)</i>	Vertical height from the ARTS 7000 antenna to the aircraft antenna entered in feet. Does not have to be 100% accurate.
Direct Cable Length (6, 20 or 60 ft)	When testing UAT over a direct/cable connection – this field is used to identify which length of coax cable that is being used between the ARTS 7000 connector and the aircraft units’ antenna feeder or antenna connector. This is used to calculate the loss in the cable.
Coupler Loss (dB)	Predetermined typical loss through Coupler. The value should be listed on the coupler itself.

UAT ADS-B In Test Screen

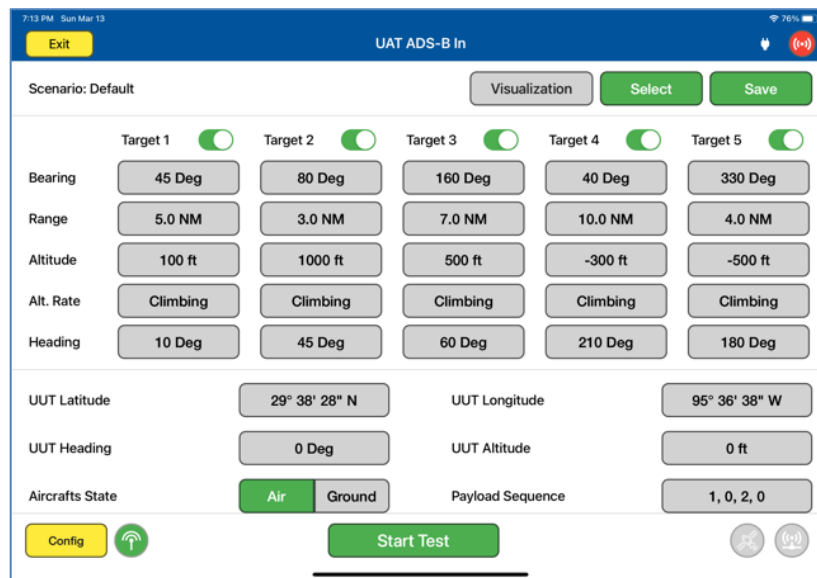

UAT ADS-B In Test Controls and Selections

Item	Description
Scenario	Pre-defined UAT ADS-B In scenario for user to select. User can also save specific scenarios created on the Test Screen for future use.
Visualization	Opens the graphical representation of the UAT ADS-B In scenario. Target parameter and aircraft under test heading can be adjusted during test.
Target 1	Toggle switch to enable Target. ARTS can generate up to 5 simultaneous UAT ADS-B In targets.

Bearing	Set bearing of respective target relative to Aircraft under test.
Range	Set range of respective target relative to Aircraft under test.
Altitude	Set altitude of respective target relative to Aircraft under test.
Alt. Rate	Set altitude rate of respective target relative to Aircraft under test. Options are 'Climbing', 'Descending', or 'Level'.
Heading	Set heading of respective target.
UUT Latitude	Set Latitude coordinates of Aircraft under test. Can use pre-set GPS coordinates stored on the iPad or ARTS unit.
UUT Longitude	Set Longitude coordinates of Aircraft under test. Can use pre-set GPS coordinates stored on the iPad or ARTS unit.
UUT Heading	Set heading of Aircraft under test.
UUT Altitude	Set altitude of Aircraft under test.
Aircraft State	Set state of targets – Air or Ground
Payload Sequence	Set payload sequence corresponding to equipment class of targets.
Base Address	Set hexadecimal base address of targets.
Base Flight ID	Set base Flight ID of targets.
Power	Set power level of ARTS radio transmission.

Test Operation – GPS Availability Tools

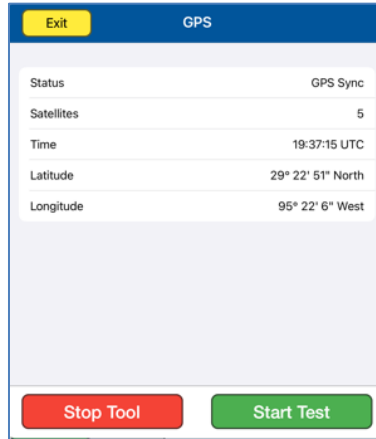

GPS Availability Tool

The GPS Tool is used to ensure a functional GPS signal is acquired by the ARTS unit to be used as part of the transmission. The test can start without a GPS signal detected, but messages may not be time synchronized.

Test Operation – Visualization Screen

When the test is run the Visualization screen automatically opens. The UUT Heading and Target parameters can be updated during test.

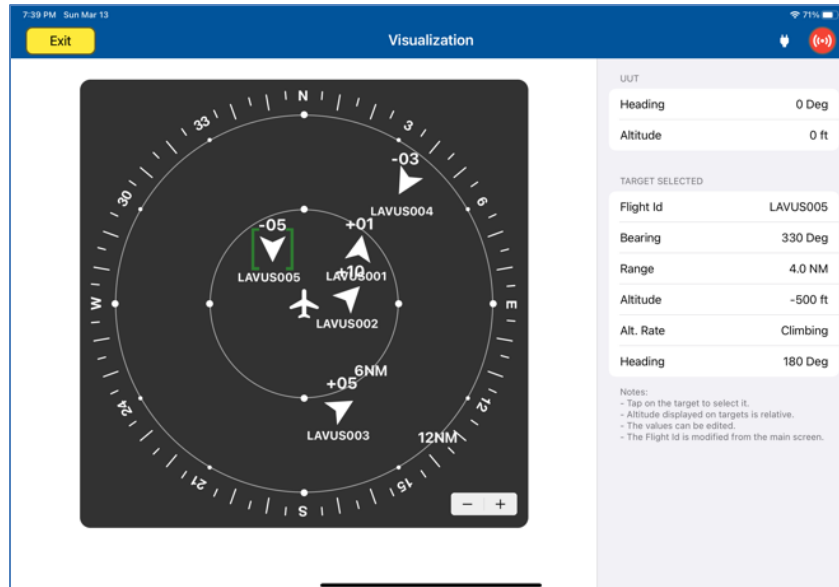

Visualization screen.

By selecting a particular target, the operator can update the relevant parameters, including Flight ID, Bearing, Range, Altitude, Altitude Rate, and Heading relative to the Aircraft under test.

SUBSECTION 5: UAT FIS-B TEST GUIDE

WARNING

It is extremely dangerous to generate signals during testing that are on the frequencies that are in use by local ATC. When operating the test set in UAT Mode, please be aware of the local navigation aid and ATC frequencies. It is the test set operator's responsibility to make sure all testing is carried out so there is no effect on other aircraft or ATC resources.

Hints and Tips

When testing transponders, if power failures are identified it is recommended to move the test antenna slightly in the horizontal plane and retest the transponder.

1. Antenna alignment is critical to successful testing of transponders. The ARTS 7000 pulse antenna is highly directional in both x- and y- planes and must be positioned in such a way that the center point of the antenna is pointed as accurately as possible to the aircraft antenna under test. Failure to get good alignment increases the likelihood of poor transmissions, reflections, and multi-path issues.



ARTS 7000 Pulse antenna showing good alignment with an aircraft bottom antenna.

Please see the section on Pulse Antenna Alignment, Reflections, and Multipath.

2. To achieve good UAT tests, it is critical that the aircraft is in the correct status (i.e. in "Air mode"). Additionally other systems may need to be operation for the Transponder to squitter data. For example, GPS position will only be available if the aircraft has valid GPS signals.

UAT FIS-B In Test Selection

1. From the Main Menu select **Test Functions**.
2. From the Test Functions menu select **ATC**.
3. From the ATC menu select **UAT**
4. From the UAT Menu Select **FIS-B**.
5. The relevant UAT FIS-B test Screen is now displayed.

UAT FIS-B Test Configuration

Before running the Test, operators can access the configuration page via the CONFIG button to establish the user preferences. The ARTS 7000 will store the last configuration used.

UAT FIS-B Test Configuration Screen

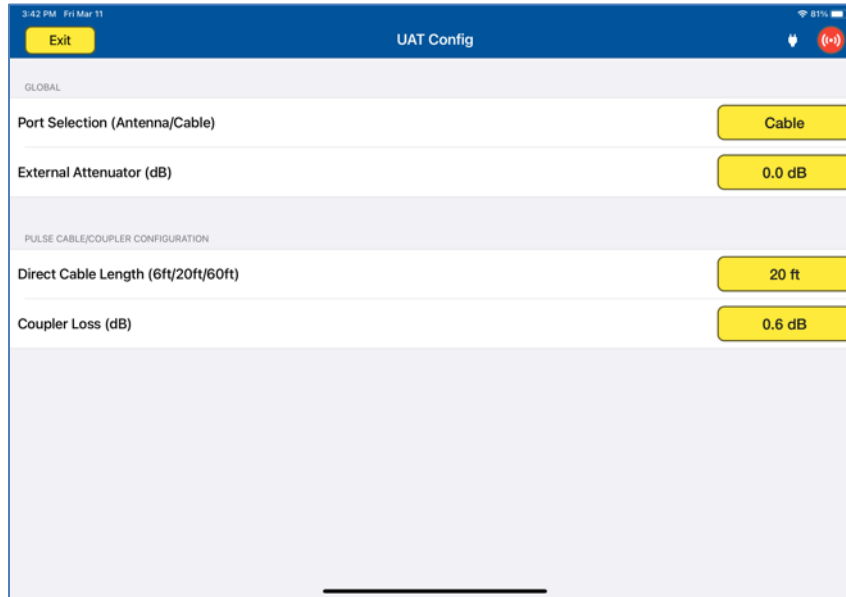

The screenshot shows the 'UAT Config' screen with the following settings:

- GLOBAL**
 - Port Selection (Antenna/Cable): Cable
 - External Attenuator (dB): 0.0 dB
- PULSE CABLE/COUPLER CONFIGURATION**
 - Direct Cable Length (6ft/20ft/60ft): 20 ft
 - Coupler Loss (dB): 0.6 dB

UAT FIS-B Test Configuration Controls and Selections

Item	Description
Port Selection (Cable/Antenna)	Selects the over the air (Antenna port) or the Direct (Cable port) connection
External Attenuator	If an external attenuator is used between the ARTS 7000 and the unit under test – sets the value of the attenuator (Cable port only)
Ant Cable Length (6, 20 or 60 ft) <i>(Not Shown above)</i>	When testing UAT over the air or antenna to antenna – this field is used to identify which length of coax cable that is being used between the ARTS 7000 connector and the ARTS 7000 Pulse antenna- this is used to calculate the loss in the cable.
Aircraft Antenna <i>(Not Shown above)</i>	Top or Bottom Antenna if diversity is available on aircraft.
Ant Range <i>(Not Shown above)</i>	Horizontal distance from the ARTS 7000 antenna to the aircraft's antenna entered in feet. Does not have to be 100% accurate.
Ant Height <i>(Not Shown above)</i>	Vertical height from the ARTS 7000 antenna to the aircraft antenna entered in feet. Does not have to be 100% accurate.

Direct Cable Length (6, 20 or 60 ft)	When testing UAT over a direct/cable connection – this field is used to identify which length of coax cable that is being used between the ARTS 7000 connector and the aircraft units' antenna feeder or antenna connector. this is used to calculate the loss in the cable.
Coupler Loss (dB)	Predetermined typical loss through Coupler. The value should be listed on the coupler itself.

UAT FIS-B Test Screen

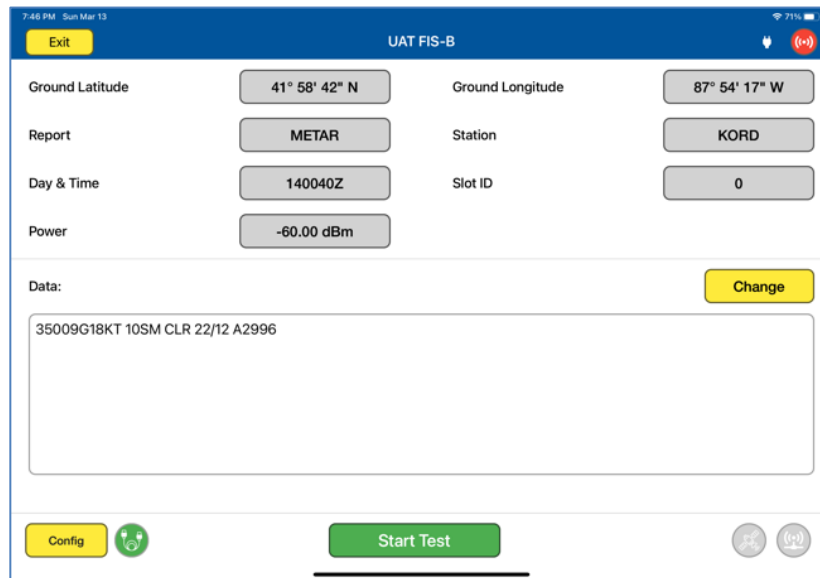

Note: FIS-B message can take between 2 to 5 minutes to display on aircraft system.

UAT FIS-B Test Controls and Selections

Item	Description
Ground Latitude	Set Latitude coordinates of the simulated station. Can be pulled from the pre-set station. Or can use pre-set GPS coordinates pulled from the iPad or ARTS unit.
Ground Longitude	Set Longitude coordinates of the simulated station. Can be pulled from the pre-set station. Or can use pre-set GPS coordinates pulled from the iPad or ARTS unit.
Report	Set the type of report – TAF or METAR.

Station	Select from a list of pre-defined stations to be used as the simulated station.
Day & Time	Set the date & time of the simulated FIS-B message. Time should be set close to current local time for message to be received by aircraft transponder.
Slot ID	Set the Slot ID related to the simulated station – 0 to 31.
Power	Set power level of ARTS radio transmission.
Data:	Field to display the pre-defined message transmitted to the Aircraft under test.
Change	Selects the pre-defined message that is being transmitted to the Aircraft under test.

Test Operation – GPS Availability Tools

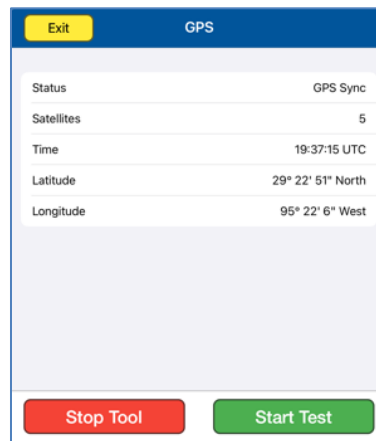

GPS Availability Tool

The GPS Tool is used to ensure a functional GPS signal is acquired by the ARTS unit to be used as part of the transmission. The test can start without a GPS signal detected, but messages may not be time synchronized.

SUBSECTION 6: UAT TIS-B TEST GUIDE

WARNING

It is extremely dangerous to generate signals during testing that are on the frequencies that are in use by local ATC. When operating the test set in UAT Mode. Please be aware of the local navigation aid and ATC frequencies. It is the test set operator's responsibility to make sure all testing is carried out so there is no effect on other aircraft or ATC resources.

Hints and Tips

When testing transponders, if power failures are identified it is recommended to move the test antenna slightly in the horizontal plane and retest the transponder

1. Antenna alignment is critical to successful testing of transponders. The ARTS 7000 pulse antenna is highly directional in both x- and y- planes and must be positioned in such a way that the center point of the antenna is pointed as accurately as possible to the aircraft antenna under test. Failure to get good alignment increases the likelihood of poor transmissions, reflections, and multi-path issues.



ARTS 7000 Pulse antenna showing good alignment with an aircraft bottom antenna.

Please see the section on Pulse Antenna Alignment, Reflections, and Multipath.

2. To achieve good UAT tests, it is critical that the aircraft is in the correct status (i.e. in "Air mode"). Additionally other systems may need to be operation for the Transponder to squitter data. For example, GPS position will only be available if the aircraft has valid GPS signals.

UAT TIS-B Test Selection

1. From the Main Menu select **Test Functions**.
2. From the Test Functions menu select **ATC**.
3. From the ATC menu select **UAT**
4. From the UAT Menu Select **TIS-B**.
5. The relevant UAT TIS-B test Screen is now displayed.

UAT TIS-B Test Configuration

Before running the Test, operators can access the configuration page via the CONFIG button to establish the user preferences. The ARTS 7000 will store the last configuration used.

UAT TIS-B Test Configuration Screen

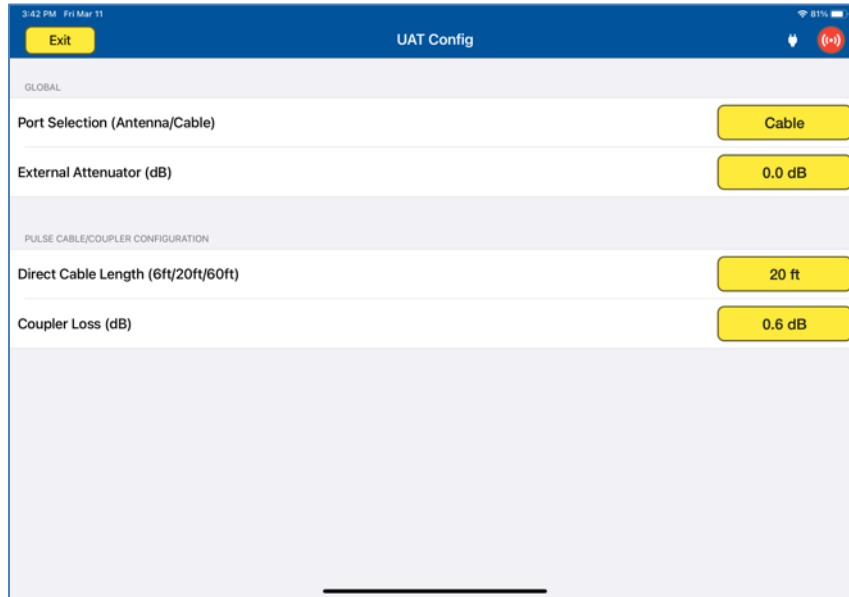

The screenshot shows the 'UAT Config' screen with the following settings:

- GLOBAL**
 - Port Selection (Antenna/Cable): Cable
 - External Attenuator (dB): 0.0 dB
- PULSE CABLE/COUPLER CONFIGURATION**
 - Direct Cable Length (6ft/20ft/60ft): 20 ft
 - Coupler Loss (dB): 0.6 dB

UAT TIS-B Test Configuration Controls and Selections

Item	Description
Port Selection (Cable/Antenna)	Selects the over the air (Antenna port) or the Direct (Cable port) connection
External Attenuator	If an external attenuator is used between the ARTS 7000 and the unit under test – sets the value of the attenuator (Cable port only)
Ant Cable Length (6, 20 or 60 ft) <i>(Not Shown above)</i>	When testing UAT over the air or antenna to antenna – this field is used to identify which length of coax cable that is being used between the ARTS 7000 connector and the ARTS 7000 Pulse antenna- this is used to calculate the loss in the cable.
Aircraft Antenna <i>(Not Shown above)</i>	Top or Bottom Antenna if diversity is available on aircraft.
Ant Range <i>(Not Shown above)</i>	Horizontal distance from the ARTS 7000 antenna to the aircraft's antenna entered in feet. Does not have to be 100% accurate.
Ant Height <i>(Not Shown above)</i>	Vertical height from the ARTS 7000 antenna to the aircraft antenna entered in feet. Does not have to be 100% accurate.

Direct Cable Length (6, 20 or 60 ft)	When testing UAT over a direct/cable connection – this field is used to identify which length of coax cable that is being used between the ARTS 7000 connector and the aircraft units' antenna feeder or antenna connector. This is used to calculate the loss in the cable.
Coupler Loss (dB)	Predetermined typical loss through Coupler. The value should be listed on the coupler itself.

UAT TIS-B Test Screen

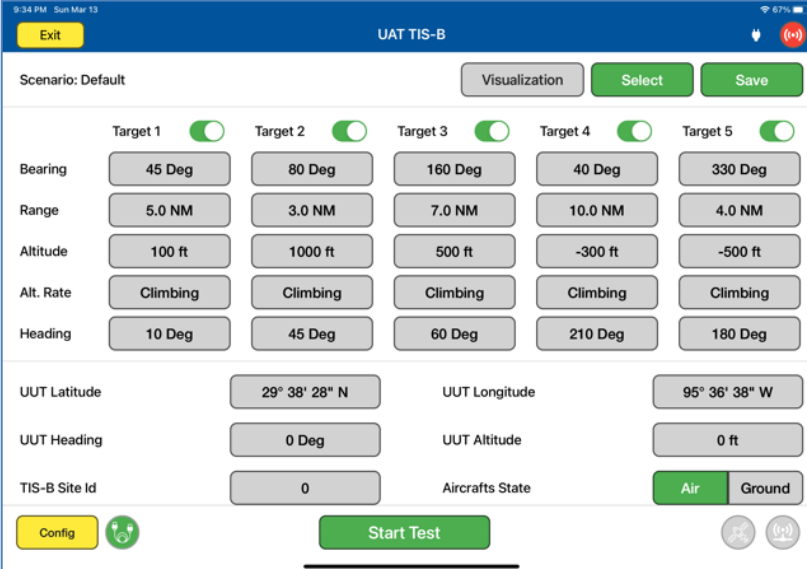

UAT TIS-B Test Controls and Selections

Item	Description
Scenario	Pre-defined UAT TIS-B scenario for user to select. User can also save specific scenarios created on the Test Screen for future use.
Visualization	Opens the graphical representation of the UAT TIS-B scenario. Target parameter and aircraft under test heading can be adjusted during test.
Target 1 	Toggle switch to enable Target. ARTS can generate up to 5 simultaneous UAT TIS-B targets.
Bearing	Set bearing of respective target relative to Aircraft under test.

Range	Set range of respective target relative to Aircraft under test.
Altitude	Set altitude of respective target relative to Aircraft under test.
Alt. Rate	Set altitude rate of respective target relative to Aircraft under test. Options are 'Climbing', 'Descending', or 'Level'.
Heading	Set heading of respective target.
UUT Latitude	Set Latitude coordinates of Aircraft under test. Can use pre-set GPS coordinates stored on the iPad or ARTS unit.
UUT Longitude	Set Longitude coordinates of Aircraft under test. Can use pre-set GPS coordinates stored on the iPad or ARTS unit.
UUT Heading	Set heading of Aircraft under test.
UUT Altitude	Set altitude of Aircraft under test.
TIS-B Site ID	Set Site ID of simulated TIS-B ground station.
Aircrafts State	Set state of targets – Air or Ground
Type	Set station source type – TIS-B or ADS-R
Payload Sequence	Set payload sequence corresponding to equipment class of targets.
Base Address	Set hexadecimal base address of targets.
Base Flight ID	Set base Flight ID of targets.
Power	Set power level of ARTS radio transmission.

Test Operation – GPS Availability Tools

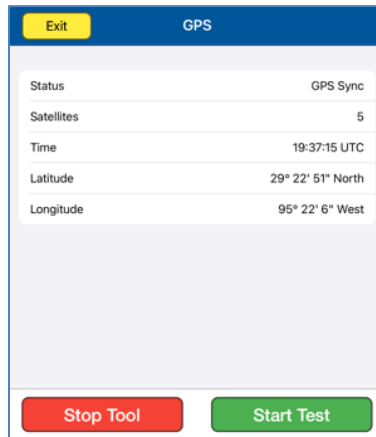

GPS Availability Tool

The GPS Tool is used to ensure a functional GPS signal is acquired by the ARTS unit to be used as part of the transmission. The test can start without a GPS signal detected, but messages may not be time synchronized.

Test Operation – Visualization Screen

When the test is run the Visualization screen automatically opens. The UUT Heading and Target parameters can be updated during test.

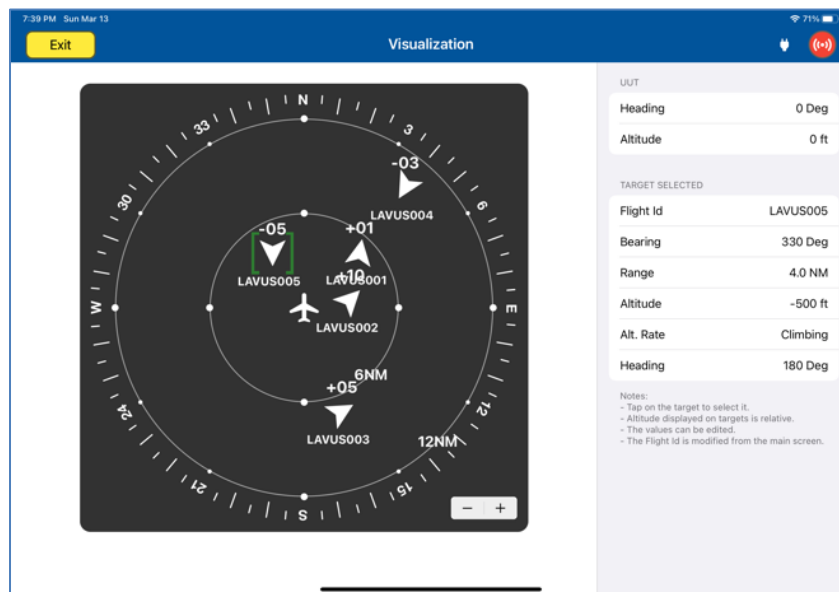

Visualization screen.

By selecting a particular target, the operator can update the relevant parameters, including Flight ID, Bearing, Range, Altitude, Altitude Rate, and Heading relative to the Aircraft under test.

SECTION 23: TIS-B (1090 MHz)

SUBSECTION 1: TIS-B OPERATION

TIS-B on 1090 MHz can be tested with aircraft equipped with corresponding transponders. It will operate similarly to TIS-B on UAT frequencies (978 MHz).

WARNING

It is extremely dangerous to generate signals during testing that are on the frequencies that are in use by local ATC. When operating the test set in TIS-B Mode, please be aware of the local navigation aid and ATC frequencies. It is the test set operator's responsibility to make sure all testing is carried out on frequencies that will not interfere with local navigation aids or ATC resources.

Hardware Required

Item	Test Type	Description / Notes	Part Number
Pulse Antenna	Ant – Ant	Yellow flat plate Pulse antenna	123-0230
Tripod	Ant – Ant	Required to mount antenna.	118-2286
Coax Cable option of 6, 20 or 60 ft	Ant – Ant Dir – Cable	Ant-Ant Operator choice of length to allow satisfactory positioning of test antenna to achieve a clear line of site to the Aircraft antenna under test. Dir-Cbl – operator choice of length recommended to use shortest possible.	VARIOUS

SUBSECTION 2: TIS-B TEST GUIDE

WARNING

It is extremely dangerous to generate signals during testing that are on the frequencies that are in use by local ATC. When operating the test set in TIS-B Mode, please be aware of the local navigation aid and ATC frequencies. It is the test set operator's responsibility to make sure all testing is carried out so there is no effect on other aircraft or ATC resources.

Hints and Tips

When testing transponders, if power failures are identified it is recommended to move the test antenna slightly in the horizontal plane and retest the transponder

1. Antenna alignment is critical to successful testing of transponders. The ARTS 7000 pulse antenna is highly directional in both x- and y- planes and must be positioned in such a way that the center point of the antenna is pointed as accurately as possible to the aircraft antenna under test. Failure to get good alignment increases the likelihood of poor transmissions, reflections, and multi-path issues.



ARTS 7000 Pulse antenna showing good alignment with an aircraft bottom antenna.

Please see the section on Pulse Antenna Alignment, Reflections, and Multipath.

2. To achieve good TIS-B tests, it is critical that the aircraft is in the correct status (i.e. in "Air mode"). Additionally other systems may need to be operation for the Transponder to squitter data. For example, GPS position will only be available if the aircraft has valid GPS signals.

TIS-B Test Selection

1. From the Main Menu select **Test Functions**.
2. From the Test Functions menu select **ATC**.
3. From the ATC menu select **TIS-B**.
4. The relevant TIS-B test Screen is now displayed.

UAT TIS-B Test Configuration

Before running the Test, operators can access the configuration page via the CONFIG button to establish the user preferences. The ARTS 7000 will store the last configuration used.

TIS-B Test Configuration Screen

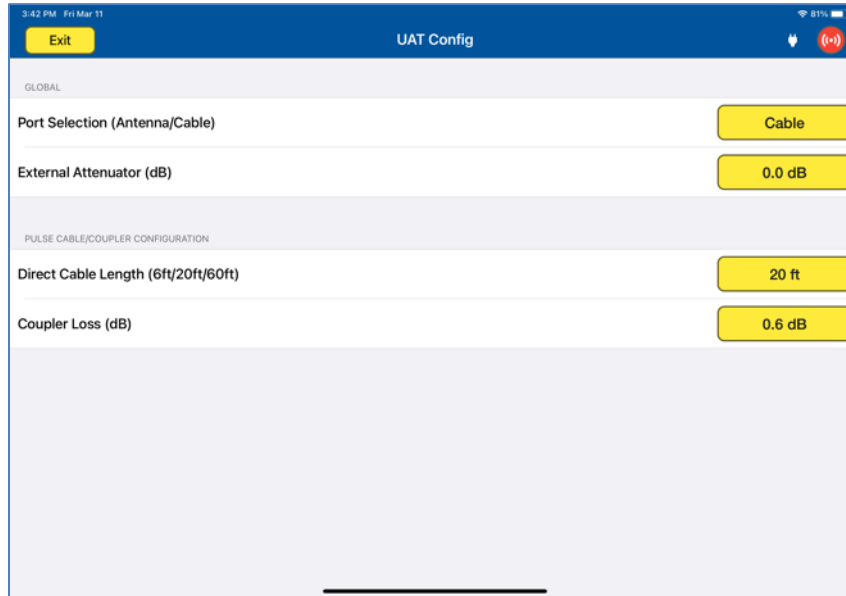

The screenshot shows the 'UAT Config' screen with the following settings:

- GLOBAL**
 - Port Selection (Antenna/Cable): Cable
 - External Attenuator (dB): 0.0 dB
- PULSE CABLE/COUPLER CONFIGURATION**
 - Direct Cable Length (6ft/20ft/60ft): 20 ft
 - Coupler Loss (dB): 0.6 dB

TIS-B Test Configuration Controls and Selections

Item	Description
Port Selection (Cable/Antenna)	Selects the over the air (Antenna port) or the Direct (Cable port) connection
External Attenuator	If an external attenuator is used between the ARTS 7000 and the unit under test – sets the value of the attenuator (Cable port only)
Ant Cable Length (6, 20 or 60 ft) <i>(Not Shown above)</i>	When testing UAT over the air or antenna to antenna – this field is used to identify which length of coax cable that is being used between the ARTS 7000 connector and the ARTS 7000 Pulse antenna- this is used to calculate the loss in the cable.
Aircraft Antenna <i>(Not Shown above)</i>	Top or Bottom Antenna if diversity is available on aircraft.
Ant Range <i>(Not Shown above)</i>	Horizontal distance from the ARTS 7000 antenna to the aircraft's antenna entered in feet. Does not have to be 100% accurate.
Ant Height <i>(Not Shown above)</i>	Vertical height from the ARTS 7000 antenna to the aircraft antenna entered in feet. Does not have to be 100% accurate.
Direct Cable Length (6, 20 or 60 ft)	When testing UAT over a direct/cable connection – this field is used to identify which length of coax cable that is being used between the ARTS 7000 connector and the aircraft units' antenna feeder or antenna connector. this is used to calculate the loss in the cable.

Coupler Loss (dB)	Predetermined typical loss through Coupler. The value should be listed on the coupler itself.
-------------------	---

TIS-B Test Screen

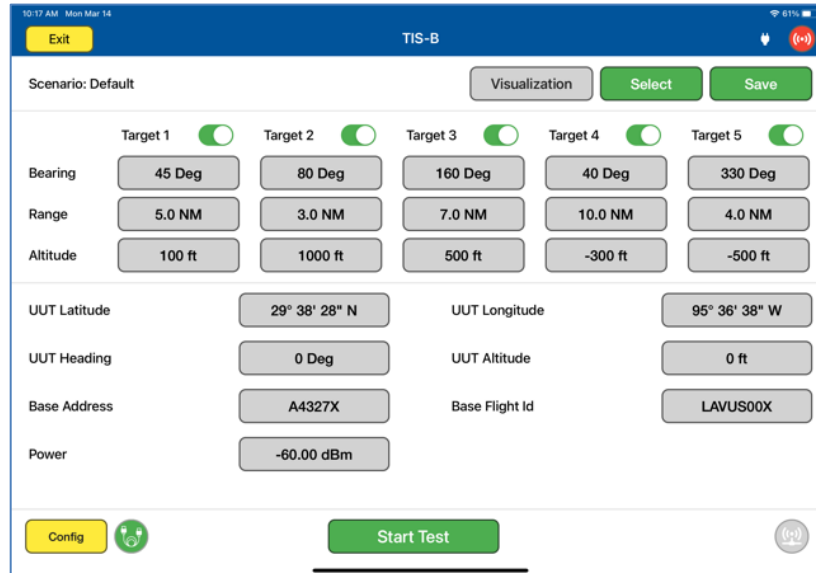

The screenshot shows the TIS-B Test Screen interface. At the top, there is a status bar with the time '10:17 AM Mon Mar 14' and battery level '61%'. Below the status bar, there is a blue header with 'Exit' and 'TIS-B' buttons. The main content area is titled 'Scenario: Default' and includes several sections:

- Visualization**: A button to toggle visualization.
- Select** and **Save**: Buttons to save the current configuration.
- Target 1-5**: Five target configuration sections, each with a toggle switch and input fields for Bearing, Range, and Altitude.

Target	Bearing	Range	Altitude
Target 1	45 Deg	5.0 NM	100 ft
Target 2	80 Deg	3.0 NM	1000 ft
Target 3	160 Deg	7.0 NM	500 ft
Target 4	40 Deg	10.0 NM	-300 ft
Target 5	330 Deg	4.0 NM	-500 ft
- UUT Parameters**: Input fields for UUT Latitude (29° 38' 28" N), UUT Longitude (95° 36' 38" W), UUT Heading (0 Deg), UUT Altitude (0 ft), Base Address (A4327X), Base Flight Id (LAVUS00X), and Power (-60.00 dBm).
- Config**: A button to access configuration options.
- Start Test**: A large green button to begin the test.

TIS-B Test Controls and Selections

Item	Description
Scenario	Pre-defined TIS-B scenario for user to select. User can also save specific scenarios created on the Test Screen for future use.
Visualization	Opens the graphical representation of the TIS-B scenario. Target parameter and aircraft under test heading can be adjusted during test.
Target 1 	Toggle switch to enable Target. ARTS can generate up to 5 simultaneous TIS-B targets.
Bearing	Set bearing of respective target relative to Aircraft under test.
Range	Set range of respective target relative to Aircraft under test.

Altitude	Set altitude of respective target relative to Aircraft under test.
UUT Latitude	Set Latitude coordinates of Aircraft under test. Can use pre-set GPS coordinates stored on the iPad or ARTS unit.
UUT Longitude	Set Longitude coordinates of Aircraft under test. Can use pre-set GPS coordinates stored on the iPad or ARTS unit.
UUT Heading	Set heading of Aircraft under test.
UUT Altitude	Set altitude of Aircraft under test.
Base Address	Set hexadecimal base address of targets
Base Flight ID	Set base Flight ID of targets.
Power	Set power level of ARTS radio transmission.

Test Operation – Visualization Screen

When the test is run the Visualization screen automatically opens. The UUT Heading and Altitude and Target parameters can be updated during test.

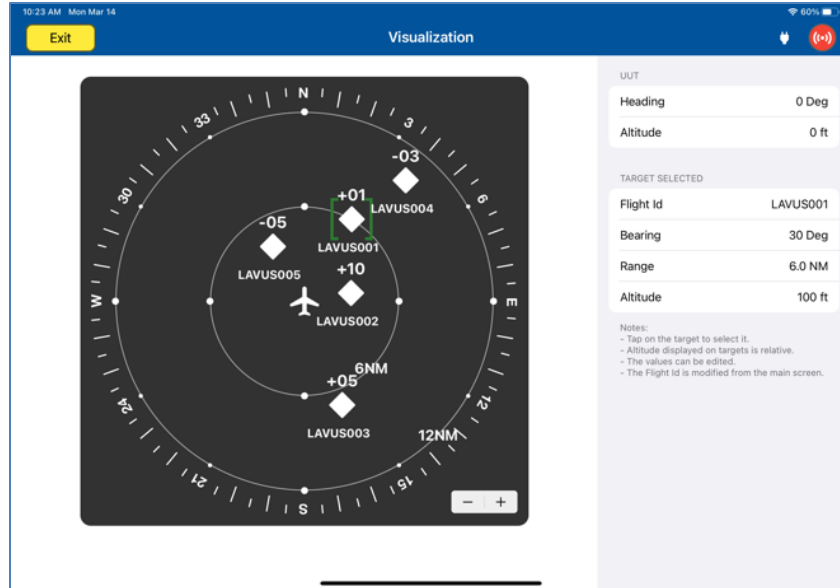

Visualization screen.

By selecting a particular target, the operator can update the relevant parameters, including Flight ID, Bearing, Range, and Altitude relative to the Aircraft under test.

SECTION 24: IDENTITY CHECK

SUBSECTION 1: IDENTITY CHECK OPERATION

The purpose of the Identity Check is to ensure Aircraft transponder 'Ident' is functioning.

WARNING

It is extremely dangerous to generate signals during testing that are on the frequencies that are in use by local ATC. When operating the test set in Mode S or ATCRBS, please be aware of the local navigation aid and ATC frequencies. It is the test set operator's responsibility to make sure all testing is carried out on frequencies that will not interfere with local navigation aids or ATC resources.

Hardware Required

Item	Test Type	Description / Notes	Part Number
Pulse Antenna	Ant – Ant	Yellow flat plate Pulse antenna	123-0230
Tripod	Ant – Ant	Required to mount antenna.	118-2286
Coax Cable option of 6, 20 or 60 ft	Ant – Ant Dir – Cable	Ant-Ant Operator choice of length to allow satisfactory positioning of test antenna to achieve a clear line of site to the Aircraft antenna under test. Dir-Cbl – operator choice of length recommended to use shortest possible.	VARIOUS

SUBSECTION 2: IDENTITY CHECK TEST GUIDE

WARNING

It is extremely dangerous to generate signals during testing that are on the frequencies that are in use by local ATC. When operating the test set in Mode S or ATCRBS, please be aware of the local navigation aid and ATC frequencies. It is the test set operator's responsibility to make sure all testing is carried out so there is no effect on other aircraft or ATC resources.

Hints and Tips

When testing transponders, if power failures are identified it is recommended to move the test antenna slightly in the horizontal plane and retest the transponder

1. Antenna alignment is critical to successful testing of transponders. The ARTS 7000 pulse antenna is highly directional in both x- and y- planes and must be positioned in such a way that the center point of the antenna is pointed as accurately as possible to the aircraft antenna under test. Failure to get good alignment increases the likelihood of poor transmissions, reflections, and multi-path issues.



ARTS 7000 Pulse antenna showing good alignment with an aircraft bottom antenna.

Please see the section on Pulse Antenna Alignment, Reflections, and Multipath.

2. To achieve good Mode S or ATCRBS tests, it is critical that the aircraft is in the correct status (i.e. in "Air mode"). Additionally other systems may need to be operation for the Transponder to squitter data. For example, GPS position will only be available if the aircraft has valid GPS signals.

Identity Check Test Selection

1. From the Main Menu select **Test Functions**.
2. From the Test Functions menu select **ATC**.
3. From the ATC menu select **Identity Check**.
4. The relevant Identity Check screen is now displayed.

Identity Check Configuration Screen

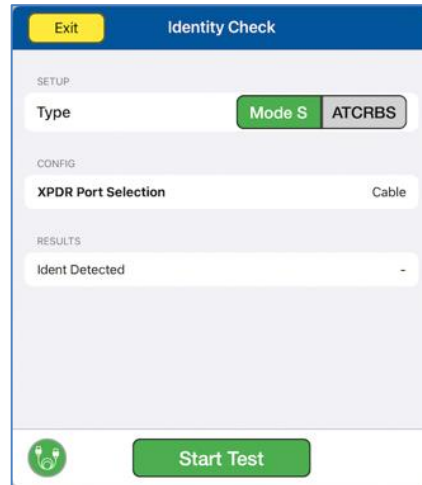

Identity Check main screen.

Identity Check Configuration Controls and Selections

Item	Description
Type	Select type of transponder to use for communication – Mode S or ATCRBS.
XPDR Port Selection (Cable / Antenna / Cable w Coupler)	Selects the over the air (Antenna port) or the Direct (Cable port) connection or Cable w/Coupler (Cable port).
Identity Detected (Result)	Displays whether the 'Ident' transmission from the Aircraft under test was received.

SECTION 25: TCAS

SUBSECTION 1: ACTIVATING TCAS

Please refer to Appendix D: License Activation Procedure if TCAS license is not already activated.

SUBSECTION 2: TCAS OPERATION

WARNING

It is extremely dangerous to generate signals during testing that are on the frequencies that are in use by local ATC and other aircraft. When operating the test set in TCAS Mode, please be aware of the local navigation aid and ATC frequencies. It is the test set operator's responsibility to make sure all testing is carried out on frequencies that will not interfere with local navigation aids or ATC resources.

Hardware Required

Item	Test Type	Description / Notes	Part Number
Pulse Antenna	Ant – Ant	Yellow flat plate Pulse antenna	123-0230
Tripod	Ant – Ant	Required to mount antenna.	118-2286
Coax Cable option of 6, 20 or 60 ft	Ant – Ant Dir – Cable	Ant-Ant Operator choice of length to allow satisfactory positioning of test antenna to achieve a clear line of site to the Aircraft antenna under test. Dir-Cbl – operator choice of length recommended to use shortest possible.	VARIOUS

SUBSECTION 3: TCAS TEST GUIDE

WARNING

It is extremely dangerous to generate signals during testing that are on the frequencies that are in use by local ATC. When operating the test set in TCAS Mode, please be aware of the local navigation aid and ATC frequencies. It is the test set operator's responsibility to make sure all testing is carried out on frequencies that will not interfere with local navigation aids or ATC resources.

WARNING

Testing top antennas often requires the use of gantries and/ or high-level platforms. This is because it is essential to get a good line of sight on the top antenna. It is advised to use

caution in these circumstances and make sure the operator ensures their safety and that of others. Please ensure the antenna is secured safely and cannot easily fall.

WARNING

Please be aware of putting an aircraft to a test altitude. Under this circumstance, when the transponder is On and the aircraft system is at an altitude, the aircraft under test will appear as a live aircraft to ATC, and other aircraft may experience false TCAS advisories.

This situation is very dangerous and may be subject to legal or financial actions.

WARNING

All ARTS 7000 ATCRBS transponder testing is carried out in accordance with Far 43 Appendix F requirements. Please ensure that using the ARTS 7000 that you are aware of the specific requirements of FAR 43 Appendix F and any other local transponder testing requirements.

Hints and Tips

When testing any Transponder, DME, or TCAS, ensure the reflective paths are minimized from equipment that is near the aircraft. Try to select a line of sight between the ARTS antenna and the Aircraft antenna that does not have any obstruction in front or behind them. For example: Ground Power Units, Aircraft Landing Gear, Aircraft Stairs, Toolboxes etc.

Hints and Tips

When testing transponders, if Power failures are identified it is recommended to move the test antenna slightly in the horizontal plane and retest the transponder.

Antenna alignment is critical to successful testing of TCAS equipment. The ARTS 7000 pulse antenna is highly directional in both x- and y- planes and must be positioned in such a way that the center point of the antenna is pointed as accurately as possible to the aircraft antenna under test.

Failure to get good alignment increases the likelihood of poor interrogations, reflections, and multi-path issues.



ARTS 7000 Pulse antenna showing good alignment with an aircraft bottom antenna.

Please see the section on Pulse Antenna Alignment, Reflections and Multipaths.

Transponder testing may take > 20 minutes depending on the capability of the transponder. It is recommended to choose the basic test first. Once the basic test is completed successfully, the full test can be run.

It is good practice to screen the antenna not under test using a suitable Antenna screen. Contact Laversab for details.

Using an antenna coupler is highly recommended to reduce radiation of the interrogation and reply signals. Please contact Laversab for details.

To achieve good transponder tests, it is critical that the aircraft is in the correct status (i.e. in "Air mode"). Additionally other systems may need to be operation for the Transponder to squitter data. For example, GPS position will only be available if the aircraft has valid GPS signals.

TCAS Test Selection

1. From the Main Menu Select **Test Functions**.
2. From the Functions menu select **TCAS**.
3. From the TCAS Menu select **TCAS**.
4. The relevant TCAS Test Screen is now displayed.

TCAS Test Configuration

Before running the Test, operators can access the configuration page via the CONFIG button to establish the user preferences. The ARTS 7000 will store the last configuration used.

TCAS Test Configuration Screen

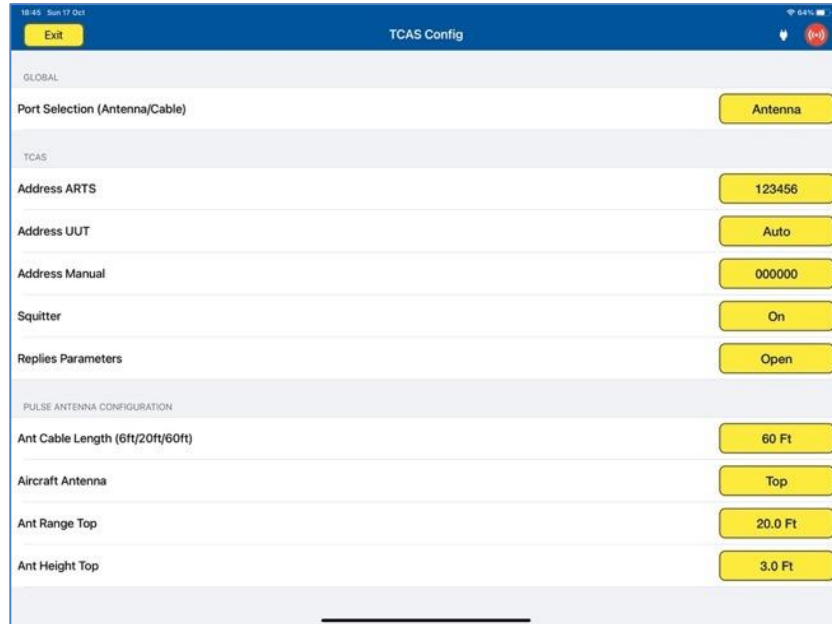

TCAS Test Configuration Controls and Selections

Item	Description
Port Selection (Cable/Antenna)	Selects the over the air (Antenna) connection Port or the Direct (Cable) Connection Port.
Address ARTS	Pseudo Address of ARTS 7000
Address UUT	Auto or Manual enter of the aircraft under Test Mode S address
Address Manual	Manually configured Hex address of target
Squitter	Can be selected On or Off
Replies Parameter	Allows selection of DF formats
Ant Cable Length (6, 20 or 60 ft)	When testing TCAS over the air or antenna to antenna – this field is used to identify which length of coax cable that is being used between the ARTS 7000 connector and the ARTS 7000 Pulse antenna- this is used to calculate the loss in the cable.
Aircraft Antenna	Top or Bottom in case of diversity





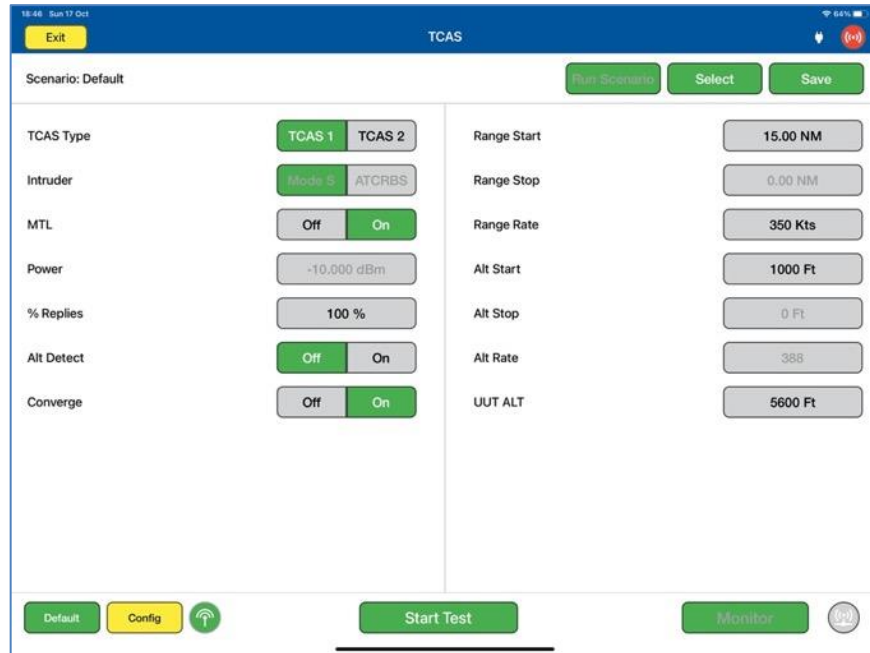







Ant Range (Top or Bottom)	Horizontal distance from the ARTS 7000 antenna to the aircraft's antenna entered in feet. Does not have to be 100% accurate.
Ant Height (Top or Bottom)	Vertical height from the ARTS 7000 antenna to the aircraft antenna entered in feet. Does not have to be 100% accurate.
Direct Cable Length (6, 20 or 60 ft) <i>(Not Shown above)</i>	When testing TCAS over a direct/cable connection – this field is used to identify which length of coax cable that is being used between the ARTS 7000 connector and the aircraft units' antenna feeder or antenna connector. This is used to calculate the loss in the cable.
Coupler Loss (dB)	Predetermined typical loss through Coupler. The value should be listed on the coupler itself.

TCAS Test Screen

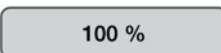

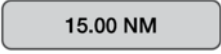
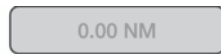
TCAS Test Controls and Selections

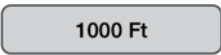
Title	Item	Description
Scenario	Scenario: Default	Identifies the selected scenario
RUN Scenario		Runs the Selected scenario

Select		Selects the Scenario to be run from the saved scenario list
Save		Saves the current scenario in the saved scenario list
TCAS Type		Selects the Scenario intruder type.
Intruder		Mode S or ATCRBS intruder transponder type.
MTL		When 'On', ARTS automatically calculates Tx Power based on simulated range of target and antenna pathloss. When 'Off', user must manually set output power.
Power		Set Output power at ARTS port when MTL is 'Off'
% Replies		Allows selection of the desired % of replies
Altitude Detect		Automatically detects the UUT altitude from the UUT Transponder
Converge		Automatically sets altitude rate of the intruder to cause a collision with the UUT aircraft. i.e. Alt 0 Ft and Nm
Range Start		Intruder Start Range
Range Stop		Intruder Stop Range
Range Rate		Closure rate of Intruder
Alt Start		Intruder Altitude Start
Alt Stop		Intruder Altitude Stop

Alt Rate	<input type="text" value="388"/>	Verticle Speed of intruder
UUT Altitude	<input type="text" value="5600 Ft"/>	Aircraft under test altitude.

Test Control Details

To test the TCAS/ACAS system, the ARTS 7000 is set up as an intruding aircraft. The intention of the test is to “fly” a pseudo (ARTS 7000 generated) intruder toward the test aircraft under test. The test is scenario based. The parameters and action of the pseudo intruder can be setup before the test is run. Under normal circumstance the intruder will approach the test aircraft and then enter the Traffic Advisory (TA) and Resolution Advisory (RA) zones of the TCAS equipped aircraft. Fundamentally, the aircraft systems and displays should identify the intruder and monitor its progress, while providing the relevant audible and visual warnings to the pilot. TA, RA and Clear of Conflict messages should be heard.

ARTS 7000 TCAS is operational for TCAS 1, TCAS 2, and ACAS systems. The User has control over all features of the intruder, including transponder type and TCAS version.

1. Scenario Selection and Management.

The ARTS 7000 is preconfigured with several scenarios. These can be selected with the **SELECT** button on the test page. The Selected scenario title is displayed in the Test Screen. The user can set up their own scenario by setting up the TCAS intruder and parameters then selecting **SAVE**. A Scenario name can be entered and stored for future recall.

2. TCAS Type

This parameter selects the nature of the intruder. Selections can be TCAS 1 or TCAS 2.

3. Intruder

Sets the Transponder type of the intruder. This can be ATRCBS or MODE S.

4. MTL

Sets the minimum trigger level of the ARTS Pseudo Transponder.

5. Power

Sets the output power level of the ARTS 7000.

6. % Replies

Allows the user to control the number of Replies that the ARTS 7000 will respond to within a range of 0-100% in 1% steps.

7. Alt Detect

When On, the ARTS 7000 will identify the UUT altitude from the Mode S data received from the aircraft. See UUT ALT below for manual altitude setting.

8. Converge

When On, the ARTS 7000 intruder will purposely fly into a collision. The scenario will end when the Altitude of the Intruder is 0Ft and 0Nm from the target aircraft.

9. Range Start

Intruder Start Range in Nautical Miles. Usually in a test this range is set initially to a distance greater than the Traffic Advisory range.

10. Range Stop

Intruder Stop Range in Nautical Miles. The Range that the intruder will stop from the test aircraft.

11. Range Rate

Range Rate is the air speed of the intruder as it approaches the test aircraft. Set in Knots.

12. Alt Start

The altitude start point of the Intruder. Set in Feet.

13. Alt Stop

The altitude stop point of the intruder. Set in Feet.

14. Alt Rate

The vertical speed of the intruder set in feet per minute.

15. UUT Altitude

Allows manual setting of the Aircraft Altitude. If Alt Detect is On, this parameter is unavailable.

Monitor Function

When the Test is running the Monitor function can be viewed by Selecting the Monitor Button. Monitor functions include, Data, Surveillance, and Broadcast.

Example of the Monitor screen showing Data information can be seen below. Other parameters can be monitored during the scenario run by selecting the relevant page.

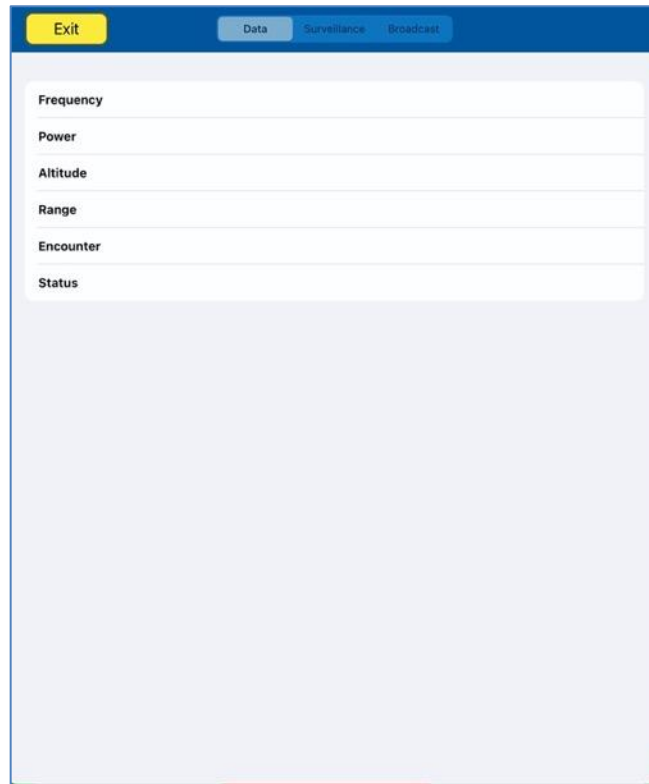

SECTION 26: TIS

SUBSECTION 1: TIS OPERATION

WARNING

It is extremely dangerous to generate signals during testing that are on the frequencies that are in use by local ATC. When operating the test set in TIS Mode, please be aware of the local navigation aid and ATC frequencies. It is the test set operator's responsibility to make sure all testing is carried out on frequencies that will not interfere with local navigation aids or ATC resources.

Hardware Required

Item	Test Type	Description / Notes	Part Number
Pulse Antenna	Ant – Ant	Yellow flat plate Pulse antenna	123-0230
Tripod	Ant – Ant	Required to mount antenna.	118-2286
Coax Cable option of 6, 20 or 60 ft	Ant – Ant Dir – Cable	Ant-Ant Operator choice of length to allow satisfactory positioning of test antenna to achieve a clear line of site to the Aircraft antenna under test. Dir-Cbl – operator choice of length recommended to use shortest possible.	VARIOUS

SUBSECTION 2: TIS TEST GUIDE

WARNING

Testing top antennas often requires the use of gantries and/ or high-level platforms. This is because it is essential to get a to get a good line of sight on the top antenna. It is advised to use caution in these circumstances and make sure the operator ensures their safety and that of others. Please ensure the antenna is secured safely and cannot easily fall.

Hints and Tips

When testing any Transponder, DME, or TCAS, ensure the reflective paths are minimized from equipment that is near the aircraft. Try to select a line of sight between the ARTS antenna and

the Aircraft antenna that does not have any obstruction in front or behind them. For example: Ground Power Units, Aircraft Landing Gear, Aircraft Stairs, Toolboxes etc.

Hints and Tips

When testing transponders, if Power failures are identified it is recommended to move the test antenna slightly in the horizontal plane and retest the transponder.

Antenna alignment is critical to successful testing of TCAS equipment. The ARTS 7000 pulse antenna is highly directional in both x- and y- planes and must be positioned in such a way that the center point of the antenna is pointed as accurately as possible to the aircraft antenna under test.

Failure to get good alignment increases the likelihood of poor interrogations, reflections, and multi-path issues.



ARTS 7000 Pulse antenna showing good alignment with an aircraft bottom antenna.

Please see the section on Pulse Antenna Alignment, Reflections and Multipaths.

Transponder testing may take > 20 minutes depending on the capability of the transponder. It is recommended to choose the basic test first. Once the basic test is completed successfully, the full test can be run.

It is good practice to screen the antenna not under test using a suitable Antenna screen. Contact Laversab for details.

Using an antenna coupler is highly recommended to reduce radiation of the interrogation and reply signals. Please contact Laversab for details.

To achieve good transponder tests, it is critical that they aircraft is in the correct status (i.e. in "Air mode"). Additionally other systems may need to be operation for the Transponder to squitter data. For example, GPS position will only be available if the aircraft has valid GPS signals.

WARNING

All ARTS 7000 TIS transponder testing is carried out in accordance with Far 43 Appendix F requirements. Please ensure that using the ARTS 7000 that you are aware of the specific requirements of FAR 43 Appendix F and any other local transponder testing requirements.

WARNING

Testing Top antenna often requires the use of gantries and/ or high-level platforms. This is because it is essential to get a to get a good line of sight on the top antenna. It is advised to use caution in these circumstances and make sure the operator ensures their safety and those around him. Please ensure the antenna is secured safely and cannot easily fall.

WARNING

Please be aware of putting an aircraft to a test altitude. Under this circumstance when the Transponder is on and the aircraft system is at an altitude the aircraft under test will trigger TCAS advisories and.

Hints and Tips

When testing any Transponders, DME or TCAS make sure the reflective paths are minimized from equipment that is in close proximity to the aircraft. Try to select a line of site between the test Set antenna and the Aircraft antenna that does not have any obstruction in front or behind the antenna being tested. For example: Ground Power Units, Aircraft Landing Gear, Aircraft Stairs, Toolboxes etc.

Hints and Tips

When Testing transponders – If Power failures are identified it is recommended to move the test antenna slightly in the horizontal plane and test the transponder again.

TIS Test Selection

1. From the Main Menu Select Test Functions.
2. From the Functions menu select TCAS.
3. From the TCAS Menu select TIS.
4. The TIS Test Screen is now displayed.

TIS Test Configuration

Before running the Test, operators can access the configuration page via the CONFIG button to establish the user preferences. The ARTS 7000 will store the last configuration used.

TIS Test Configuration Screen

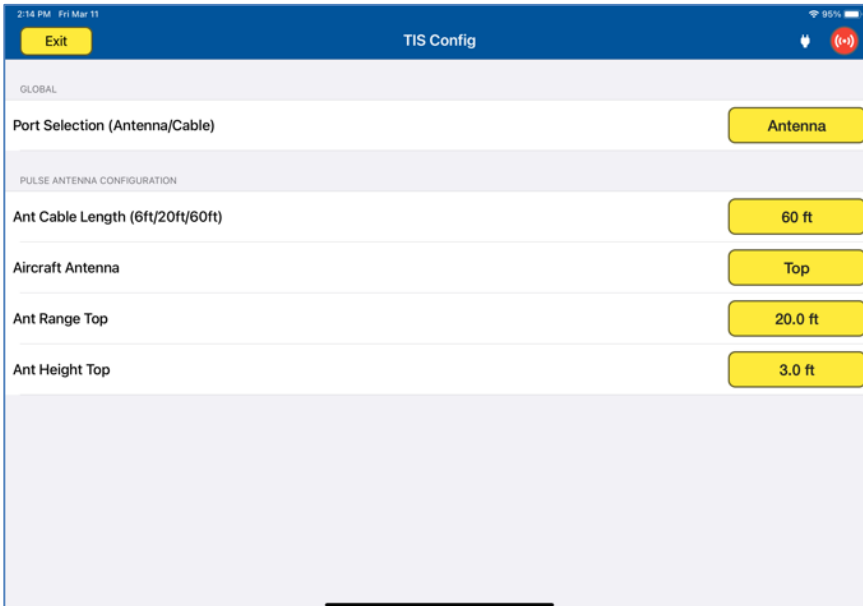

TIS Test Configuration Controls and Selections

Item	Description
Port Selection (Cable/Antenna)	Selects the over the air (Antenna port) or the Direct (Cable port) connection or Cable w/Coupler (Cable port)
External Attenuator (dB) <i>(Not shown above)</i>	When an attenuator is used the value of the attenuator should be entered in this field (Cable port only)
Ant Cable Length (6, 20 or 60 ft)	When testing TIS over the air or antenna to antenna – this field is used to identify which length of coax cable that is being used between the ARTS 7000 connector and the ARTS 7000 Pulse antenna- this is used to calculate the loss in the cable.
Aircraft Antenna	Top or Bottom Antenna if diversity is available on aircraft.
Ant Range	Horizontal distance from the ARTS 7000 antenna to the aircraft's antenna entered in feet. Does not have to be 100% accurate.
Ant Height	Vertical height from the ARTS 7000 antenna to the aircraft antenna entered in feet. Does not have to be 100% accurate.
Direct Cable Length (6, 20 or 60 ft) <i>(Not Shown above)</i>	When testing TIS over a direct/cable connection – this field is used to identify which length of coax cable that is being used between the ARTS 7000 connector and the aircraft units' antenna feeder or antenna connector. This is used to calculate the loss in the cable.

Coupler Loss (dB)	Predetermined typical loss through Coupler. The value should be listed on the coupler itself.
-------------------	---

TIS Test Screen

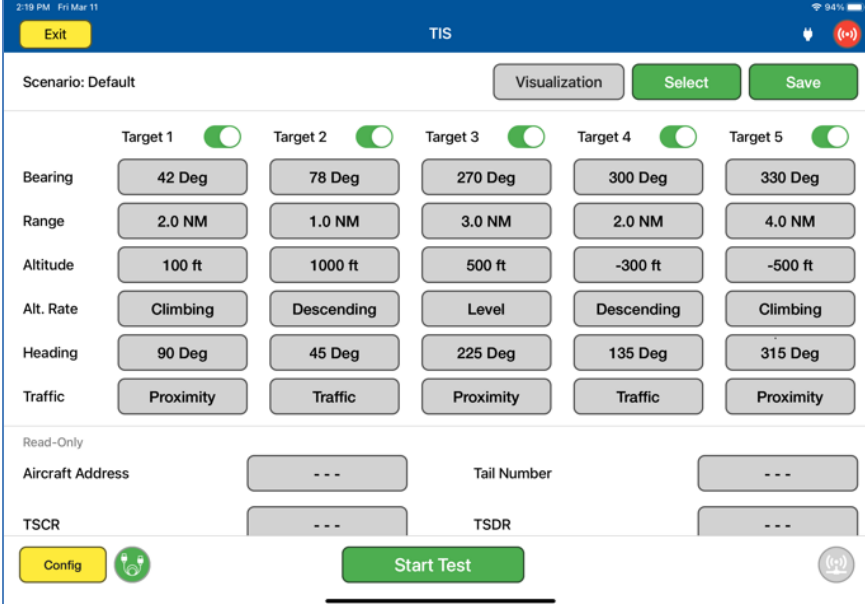

2:10 PM - Fri Mar 11

Exit TIS Visualization Select Save

Scenario: Default

Target 1 Target 2 Target 3 Target 4 Target 5

Bearing	42 Deg	78 Deg	270 Deg	300 Deg	330 Deg
Range	2.0 NM	1.0 NM	3.0 NM	2.0 NM	4.0 NM
Altitude	100 ft	1000 ft	500 ft	-300 ft	-500 ft
Alt. Rate	Climbing	Descending	Level	Descending	Climbing
Heading	90 Deg	45 Deg	225 Deg	135 Deg	315 Deg
Traffic	Proximity	Traffic	Proximity	Traffic	Proximity

Read-Only

Aircraft Address --- Tail Number ---

TSCR --- TSDR ---

Config Start Test

TIS Test Controls and Selections

Item	Description
Scenario	Pre-defined TIS scenario for user to select. User can also save specific scenarios created on the Test Screen for future use.
Visualization	Opens the graphical representation of the TIS scenario. Target parameter and aircraft under test heading can be adjusted during test.
Target 1 <input checked="" type="checkbox"/>	Toggle switch to enable Target. ARTS can generate up to 5 simultaneous TIS targets.
Bearing	Set bearing of respective target relative to Aircraft under test.
Range	Set range of respective target relative to Aircraft under test.

Altitude	Set altitude of respective target relative to Aircraft under test.
Alt. Rate	Set altitude rate of respective target relative to Aircraft under test. Options are 'Climbing', 'Descending', or 'Level'.
Heading	Set heading of respective target.
Traffic	Set traffic status of respective target. Options are 'Proximity' or 'Traffic'.
UUT Heading <i>(Not shown above)</i>	Set heading of Aircraft under test.
Power <i>(Not shown above)</i>	Set power level of ARTS radio transmission.

TIS Test Results

Item	Description
Aircraft Address	Reading of the Mode S address of the Aircraft Under Test.
Tail Number	Reading of the Tail Number of the Aircraft Under Test.
TSCR	TIS Service Connect Request: Count of connect requests made by the Aircraft Under Test.
TSDR	TIS Service Disconnect Request: Counter of disconnect requests made by the Aircraft Under Test.

Test Operation – Visualization Screen

When the test is run the Visualization screen automatically opens. The UUT Heading and Target parameters can be updated during test.

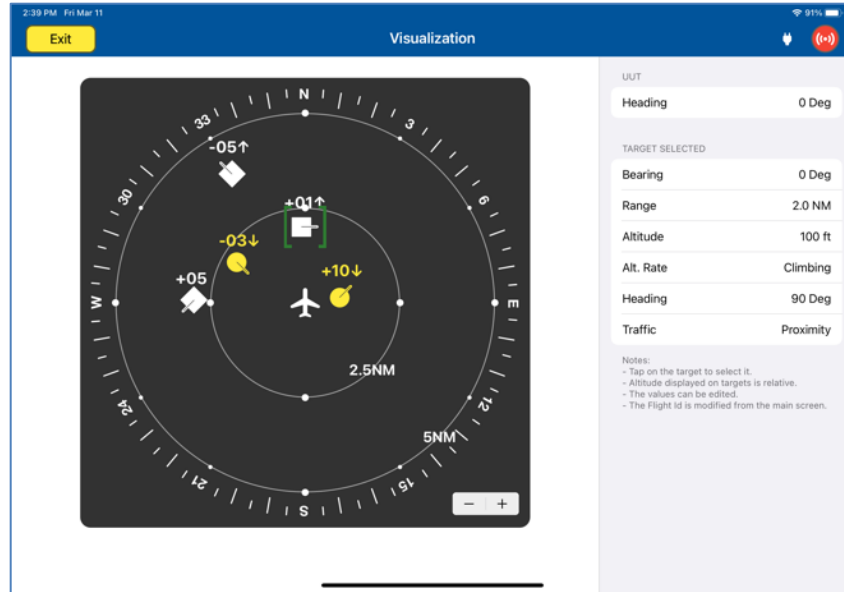

Visualization screen.

By selecting a particular target, the operator is able to update the relevant parameters, including Bearing, Range, Altitude, Altitude Rate, Heading, and Traffic status relative to the Aircraft under test.

SECTION 27: ALTITUDE MONITORING

SUBSECTION 1: ALTITUDE MONITORING DESCRIPTION

Altitude Monitoring is a unique feature of Laversab ARTS 7000 and Laversab Air Data Test Sets. The ARTS 7000 can be connected to a Laversab Air Data test set using an umbilical cable. This allows simultaneous control over both test sets using a single Test Control tablet. In this mode the ADTS altitude can be adjusted while monitoring the Transponder's Mode S and Mode C Altitude.

SUBSECTION 2: ALTITUDE MONITORING TRANSPONDER SETUP

The ARTS 7000 is set up in the same method as Mode S testing. Please review the Mode S procedure for details.

WARNING

It is extremely dangerous to generate signals during testing that are on the frequencies that are in use by local ATC. When operating the test set in Mode S, please be aware of the local navigation aid and ATC frequencies. It is the test set operator's responsibility to make sure all testing is carried out on frequencies that will not interfere with local navigation aids or ATC resources.

Hardware Required

Item	Test Type	Description / Notes	Part Number
Pulse Antenna	Ant - Ant	Yellow flat plate Pulse antenna	123-0230
Tripod	Ant - Ant	Required to mount antenna.	118-2286
Co Ax Cable option of 6, 20 or 60 ft	Ant - Ant Dir - Cable	Ant-Ant Operator choice of length to allow satisfactory positioning of test antenna to achieve a clear line of site to the Aircraft antenna under test. Dir-Cbl – operator choice of length recommended to use shortest possible.	VARIOUS
Coupler	Ant - Coupler	Antenna Coupler See the Antenna Coupler Section of this document	123-0237
RS232 straight through cable (male connectors)	Umbilical cable	RS232 cable to connect ARTS 7000 to Laversab ADTS	N/A

WARNING

All ARTS 7000 Mode S transponder testing is carried out in accordance with Far 43 Appendix F requirements. Please ensure that using the ARTS 7000 that you are aware of the specific requirements of FAR 43 Appendix F and any other local transponder testing requirements.

WARNING

It is extremely dangerous to generate signals during testing that are on the frequencies that are in use by local ATC. When operating the test set in Mode S, please be aware of the local navigation aid and ATC frequencies. It is the test set operator's responsibility to make sure all testing is carried out on frequencies that will not interfere with local navigation aids or ATC resources.

WARNING

Testing Top antenna often requires the use of gantries and/ or high-level platforms. This is because it is essential to get a good line of sight on the top antenna. It is advised to use caution in these circumstances and make sure the operator ensures their safety and those around him. Please ensure the antenna is secured safely and cannot easily fall.

WARNING

Please be aware of putting an aircraft to a test altitude. Under this circumstance when the Transponder is on and the aircraft system is at an altitude the aircraft under test will trigger TCAS advisories and.

Hints and Tips

When testing any Transponders, DME or TCAS make sure the reflective paths are minimized from equipment that is in close proximity to the aircraft. Try to select a line of site between the test Set antenna and the Aircraft antenna that does not have any obstruction in front or behind the antenna being tested. For example: Ground Power Units, Aircraft Landing Gear, Aircraft Stairs, Toolboxes etc.

Hints and Tips

When Testing transponders – If Power failures are identified it is recommended to move the test antenna slightly in the horizontal plane and test the transponder again.

Antenna alignment is critical to successful testing of TCAS equipment. The ARTS 7000 pulse antenna is highly directional in both x- and y- planes and must be positioned in such a way that the center point of the antenna is pointed as accurately as possible to the aircraft antenna under

test. Failure to get good alignment increases the likelihood of poor interrogations, reflections, and multi-path issues.



ARTS 7000 Pulse antenna showing good alignment with an aircraft bottom antenna.

Please see the section on Pulse Antenna Alignment, Reflections and Multi-path.

1. Transponder testing may take > 20 minutes depending on the capability of the transponder. It is recommended to choose the basic test first as it is relatively fast. Once the basic test is completed successfully the full test can be run.
2. It is good practice to screen the antenna not under test using a suitable antenna screen. A secondary Laversab Coupler can be used as a screen with the 50 Ohm terminating connector.
3. Using an antenna coupler is highly recommended to reduce radiation of the interrogation and reply signals. Please contact Laversab for details.
4. To achieve good transponder tests, it is critical that the aircraft is in the correct status (i.e. in "Air mode"). Additionally other systems may need to be operating for the Transponder to squitter data. For example, GPS position will only be available if the aircraft has valid GPS signals.

SUBSECTION 3: ALTITUDE MONITORING AIR DATA TEST SET SETUP.

Setup the Laversab ADTS per the Start Up procedure for each model. Please refer to the Laversab ADTS operating manuals, which is shipped with the unit and can be found on laversab.com/aviation/download-center.

ADTS Setup

1. Set Pitot units to 'Knots' and Static units to 'Feet'.
2. If ADTS is a 3-channel unit, set Ps2 units to 'Dfin' and Ps2 target value to '0.0'
3. Connect the ADTS to the aircraft and perform a low-level leak check.

4. After low-level leak check is complete, set the ADTS to Control mode.
Connect the ADTS to the ARTS using a straight through serial cable.

SUBSECTION 4: ALTITUDE MONITORING TEST DETAILS

Connection of the ADTS and ARTS 7000



ADTS RS232 port



ARTS 7000 RS232 port

Connect the RS232 port of the ARTS 7000 to the RS232 of the Laversab ADTS using a straight through serial cable with male connectors on both ends.

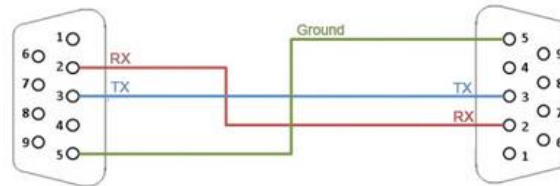

Straight Through serial cable wiring diagram

Once the ARTS 7000 and the ADTS is set up and functioning correctly the Altitude Monitoring test can be selected.

Altitude Monitoring Test Selection

1. From the Main Menu select **Test Functions**.
2. From the Functions menu select **Altitude Monitoring**.
3. The relevant Altitude Monitoring Test Screen is now displayed.

Altitude Monitoring Test Configuration

Before running the Test, operators can access the configuration page via the CONFIG button to establish the user preferences. The ARTS 7000 will store the last configuration used.

Altitude Monitoring Test Configuration Screen

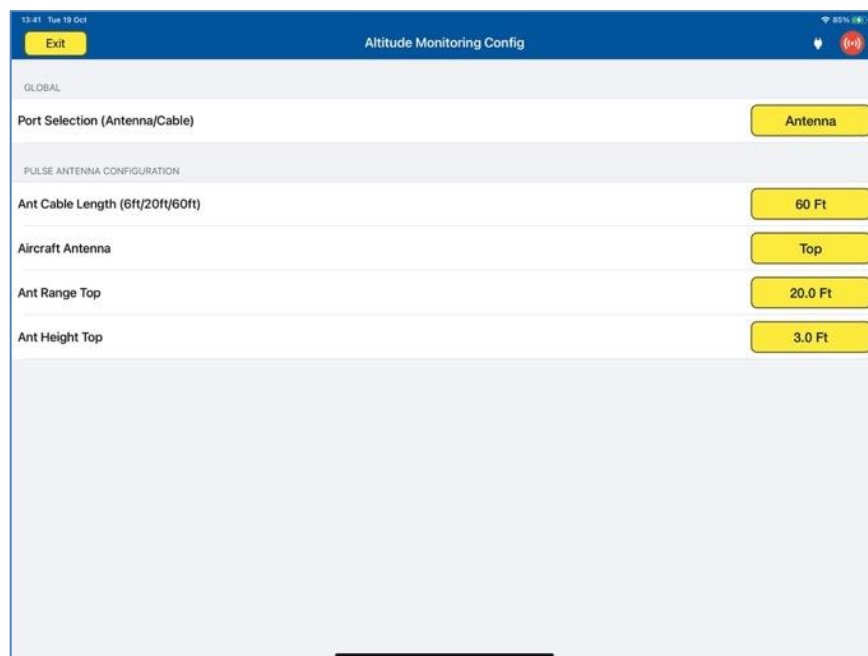

Altitude Monitoring Test Configuration Controls and Selections

Item	Description
Port Selection (Cable/Antenna)	Selects the over the air (Antenna) connection Port or the Direct (Cable) Connection Port.
Ant Cable Length (6, 20 or 60 ft)	When testing MODE S over the air or antenna to antenna – this field is used to Identify which length of coax cable that is being used between the ARTS 7000 connector and the ARTS 7000 Pulse antenna. This is used to calculate the loss in the cable.
Aircraft Antenna	Select which antenna is to be tested - Top or Bottom - in a dual antenna installation. Set to Bottom for a single antenna installation.
Ant Range Top	Horizontal distance from the ARTS 7000 antenna to the aircrafts top antenna entered in feet. Does not have to be 100% accurate.
Ant Height Top	Vertical distance from the aircrafts antenna to the ground entered in feet. Does not have to be 100% accurate.
Direct Cable Length (6ft/20ft/60ft) (Not shown above)	When testing Mode S over a direct/cable connection – this field is used to identify which length of coax cable that is being used between the ARTS 7000 connector and the aircraft units' antenna feeder or antenna connector. this is used to calculate the loss in the cable.



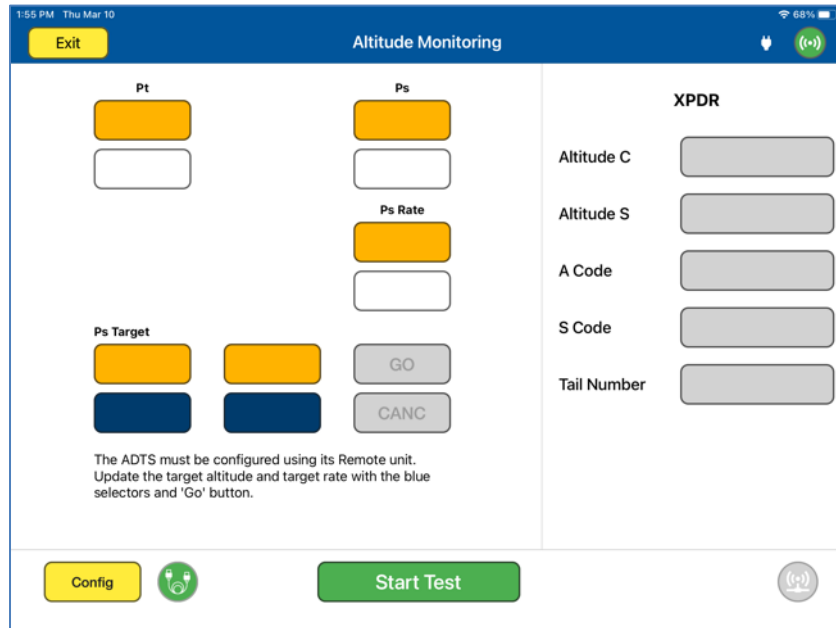

Coupler Loss (dB) <i>(Not shown above)</i>	Predetermined typical loss through Coupler. The value should be listed on the coupler itself.
---	---

Altitude Monitoring Test Screen

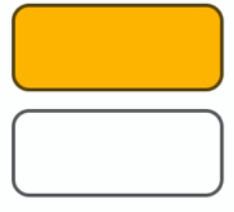
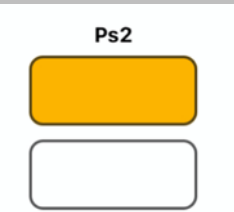

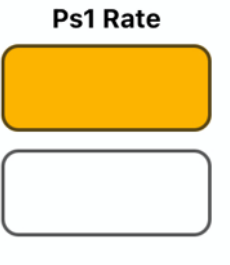
Altitude Monitoring Test Controls and Selections

Item	Description
Pt 	Yellow Box: Pt unit; must be 'Knots' White Box: Pt actual value
Ps2 	(For 3-channel units only) Yellow Box: Ps2 unit; must be 'Feet' White Box: Ps2 actual value

<p style="text-align: center;">Ps1</p> 	<p>(Ps1 for 3-channel units only, otherwise Ps) Yellow Box: Ps1/Ps unit; must be 'Feet'</p> <p>White Box: Ps1/Ps actual value</p>
<p style="text-align: center;">Ps1 Rate</p> 	<p>(Ps1 for 3-channel units only, otherwise Ps) Yellow Box: Ps1/Ps Rate unit; must be 'Feet/min'</p> <p>White Box: Ps1/Ps rate actual value</p>
<p style="text-align: center;">Ps1 Targets</p> 	<p>(Ps1 for 3-channel units only, otherwise Ps) Yellow Box: Ps1/Ps Target units; must be 'Feet' & 'Feet/min'</p> <p>Blue Box: Ps1/Ps target values. Use to update target altitude & target rate.</p>
	<p>Execute command to change target altitude or rate.</p>
	<p>Cancel command to change target altitude or rate.</p>
<p>Altitude C <input type="text"/></p>	<p>Displays the live Mode C altitude of the aircraft transponder.</p>
<p>Altitude S <input type="text"/></p>	<p>Displays the live Mode S altitude of the aircraft transponder.</p>
<p>A Code <input type="text"/></p>	<p>Displays the MODE A code from the aircraft transponder under test.</p>
<p>S Code <input type="text"/></p>	<p>Displays the MODE S code from the aircraft transponder under test.</p>
<p>Tail Number <input type="text"/></p>	<p>Displays the Tail number from the aircraft transponder under test.</p>

SECTION 28: GPS SIMULATOR

SUBSECTION 1: GPS SIMULATOR OPERATION

The ARTS-7000 GPS Simulator can simulate GPS satellite constellation time and position to exercise an aircraft GPS receiver system. The ARTS-7000 can simulate a fixed (stationary) position or a motion path.

WARNING

It is extremely dangerous to generate and radiate simulated GPS signals, as they can interfere with navigational aid of surrounding equipment. When operating the test set in GPS Mode, please only use with a Laversab approved GPS Coupler. It is the test set operator's responsibility to make sure all testing is carried out on frequencies that will not interfere with local navigational aids or ATC resources.

Hardware Required

Item	Test Type	Description / Notes	Part Number
ARTS-7000 GPS Module	Module	Module for ARTS-7000.	115-2048
Coax Cable option of 6, 20 or 60 ft	Ant – Coupler	Operator choice of length to allow satisfactory positioning of test coupler over aircraft GPS antenna under test.	VARIOUS
	Dir – Cable	Connect directly from ARTS GPS to the aircraft GPS receiver.	
GPS Coupler	Ant – Coupler	Required to prevent GPS signals interference. Can be used as a shield as well.	115-2046

SUBSECTION 2: GPS SIMULATOR TEST GUIDE

WARNING

It is extremely dangerous to generate and radiate simulated GPS signals, as they can interfere with navigational aid of surrounding equipment. When operating the test set in GPS Mode, please only use with a Laversab approved GPS Coupler. It is the test set operator's responsibility to make sure all testing is carried out on frequencies that will not interfere with local navigational aids or ATC resources.

Hints and Tips

It is often useful to use two GPS Couplers for aircraft with dual GPS antenna. Using a tee connector and two cables, both couplers can signal the aircraft GPS receiver. Or one coupler can generate the signal while the other is used to shield non-simulated GPS signal. An unshielded aircraft antenna risks receiving a mix of simulated GPS signal and real-world signal, which can create instability in the aircraft GPS receiver.

1. The GPS Test must be performed with a Laversab approved GPS Coupler to prevent simulated signals from interfering with other equipment. Connect the GPS Coupler to the ARTS GPS module via coax cable. Cover the aircraft GPS antenna with the coupler.
2. For aircraft with dual GPS antennae, use two couplers and a tee connector to ensure the simulated signal is received by both antennae.



ARTS 7000 GPS couplers covering dual aircraft antennae.

3. To ensure a good simulation, the ARTS-7000 GPS simulator should be started, followed by an aircraft receiver cold start. It can take several minutes before the simulated signal is recognized by the aircraft receiver under test.
4. Use a simulation time later than the almanac date to avoid any misreading by the aircraft receiver under test.

GPS Test Selection

1. From the Main Menu select **Test Functions**.
2. From the Test Functions menu select **GPS**.
3. The GPS test screen is now displayed.

GPS Test Configuration

Before running the Test, operators can access the configuration page via the CONFIG button to establish the user preferences. The ARTS 7000 will store the last configuration used.

GPS Test Configuration Screen

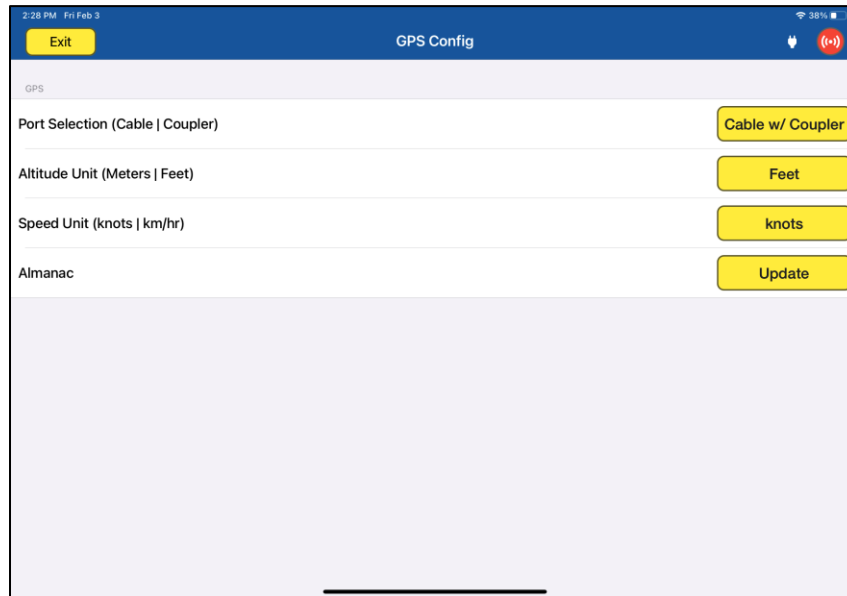

GPS Test Configuration Controls and Selections

Item	Description
Port Selection (Cable Coupler)	Selects the appropriate gain for Direct (Cable) connection or Cable w/ Coupler (Coupler) method.
Altitude Unit (Meters Feet)	Unit of altitude measurement.
Speed Unit (knots km/hr)	Unit of speed measurement.
Almanac ¹	Ability for user to update the Almanac of the GPS module. Requires ARTS-7000 app connection to internet to download latest almanac.

1. Available almanacs will be displayed. It is important to select an almanac that is less than 30 days old to ensure a good simulation.

GPS Test Screens

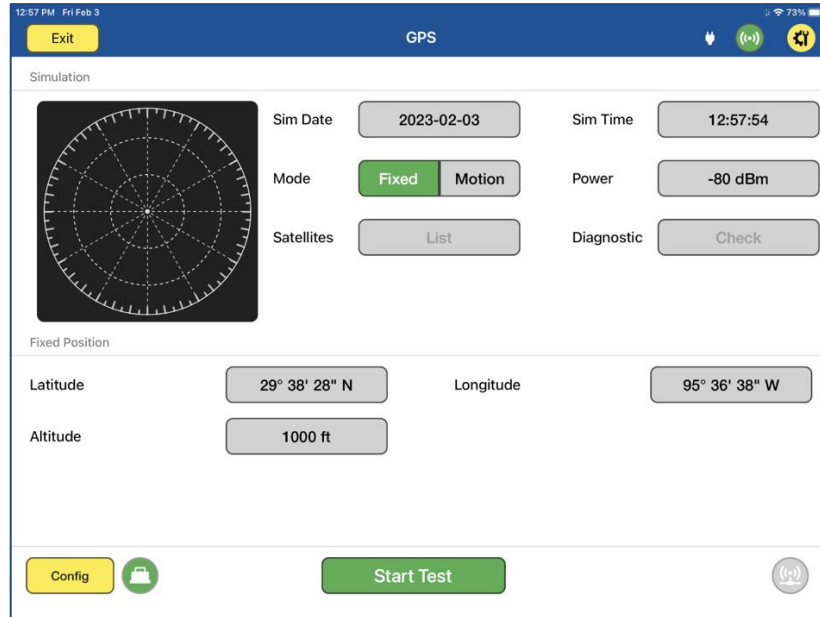

Fixed Mode Test Screen

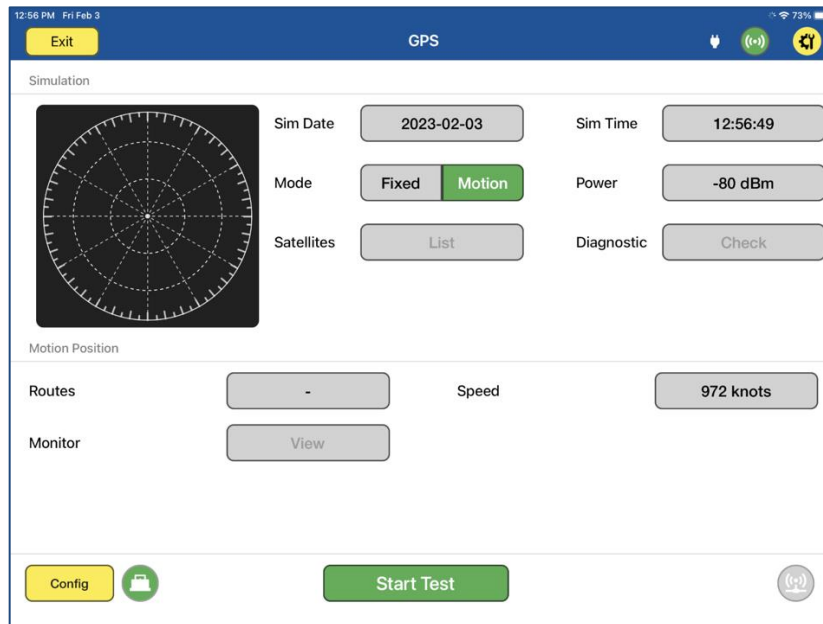

Motion Mode Test Screen

GPS Test Controls and Selections

Item	Description
Sim Date	Set date to be simulated.
Sim Time	Set time to be simulated
Mode	Fixed: Constant GPS position to be generated – latitude, longitude, altitude. Motion: Simulate a GPS route and speed for the aircraft under test.
Power	Set power level of GPS signal.
Satellites	View list of visible satellites to set health status.
Diagnostic	Check signal generated by ARTS-7000 (internal loop verification).
Latitude (Fixed mode)	Set simulated latitude coordinates for Aircraft under test.
Longitude (Fixed mode)	Set simulated longitude coordinates for Aircraft under test.
Altitude (Fixed mode)	Set simulated altitude for Aircraft under test.
Routes (Motion mode)	Create simulated route via waypoints. Save and recall routes.
Speed (Motion mode)	Set simulated aircraft speed through route.
Monitor (Motion mode)	View progress through route through a map interface.

Test Operation – GPS Route Creation (Motion mode only)

The GPS Motion mode enables the operator to create a specific route via GPS waypoints. The map can be accessed from the test page while in Motion mode by selecting **Routes**.

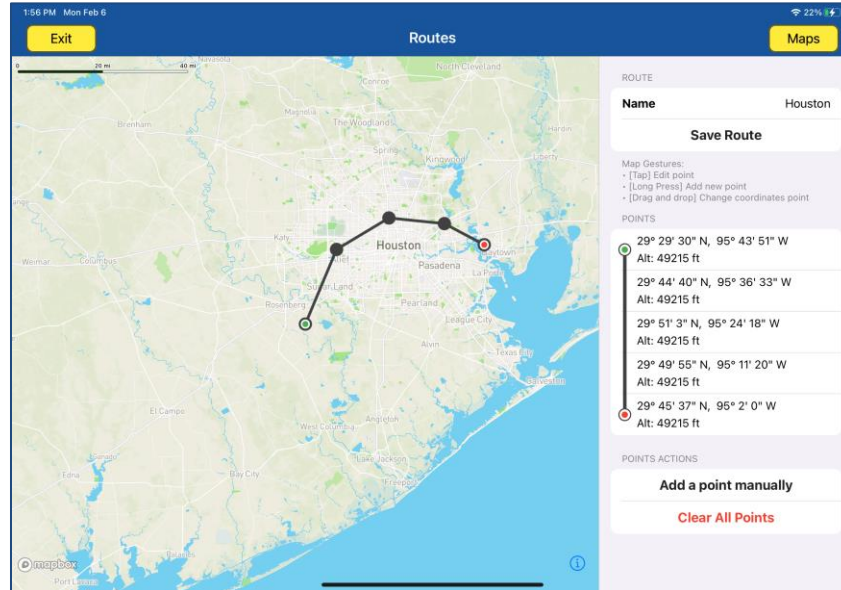

Route creating screen.

A route is created via an interactive map (press and hold) or by manually adding or deleting waypoints. New routes can be saved using the **Save Route** button. Saved routes can be recalled by pressing the **Name** button.

Map information for 10 different regions can be saved to the ARTS-7000 app for use across various Route scenarios. The map information can only be downloaded when the ARTS-7000 app is connected to the internet. Use the **Maps** button and **Add Region** button to save map information for a particular region.

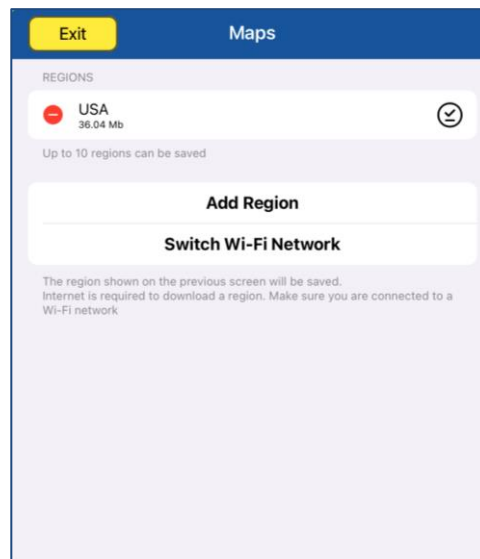

Saving regions to the ARTS-7000 app.

Test Operation – GPS Satellite Status

The test can be started from the main test screen by using the **Start Test** button. In Motion Mode, this will bring up the Monitor window, which shows progress of the Motion route.

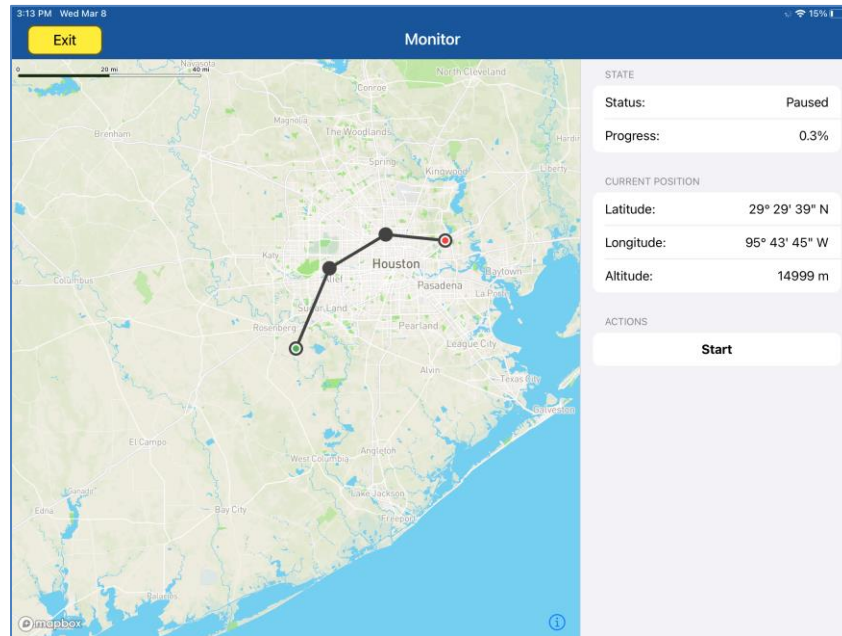

Monitor screen during Motion Mode.

Pressing **start** in this window will begin the route.

Test Operation – GPS Satellite Status

Accessing the Satellite List enables the operator to view and update the health status of all satellites, whether visible or not. Status can be updated between **Good**, **Weak**, and **Dead**.

Satellites visible	
Title	Status
PRN 01	Good >
PRN 04	Good >
PRN 07	Good >
PRN 08	• Good >
PRN 09	Good >
PRN 14	Good >
PRN 16	• Good >
PRN 21	Good >
PRN 27	• Weak >
PRN 30	Good >

The red dot indicates that a satellite's health value was overwritten.

Satellites not visible	
Title	Status

Satellite List screen.

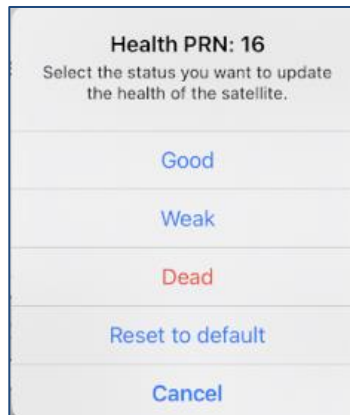

Satellite Health Status update.

Test Operation – Diagnostic

To check the behavior of the GPS module, use the **Check** button to read the message of the GPS simulator to ensure a good signal is being transmitted. This is a useful diagnostic tool to ensure the GPS simulator is behaving as expected.

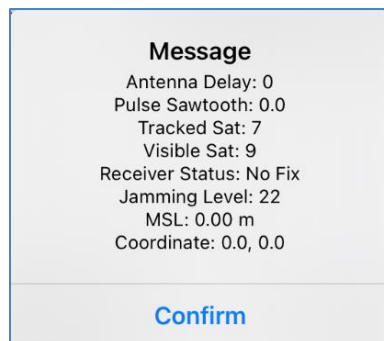

GPS Diagnostic check.

SECTION 29: VSWR / LOSS

SUBSECTION 1: VSWR / LOSS OPERATION

The ARTS 7000 Test System can be configured with a VSWR + Distance to Fault (DTF) module. This module can assist in diagnosing issues in the signal path due to shorts, reflections, or unexpected signal loss. The module performs a sweep across user-defined frequencies, returns the VSWR chart across those frequencies. The module can also perform S21 gain to characterize any ripple in cables or system components.

WARNING

It is extremely dangerous to generate signals during testing that are on the frequencies that are in use by local ATC. When operating the Test Set, please be aware of the local ATC frequencies. It is the test set operator's responsibility to make sure all testing is carried out on frequencies that will not interfere with local navigational aids or ATC resources.

Please See Appendix A for technical specifications.

Test Hardware Required

Item	Test Type	Description / Notes	Part Number
ARTS-7000 VSWR + DTF Module	Module	Module for ARTS-7000.	115-2049
Coax Cable option of 6, 20 or 60 ft (optional)	Dir – Cable	Operator choice to connect to unit under test.	VARIOUS

SUBSECTION 2: VSWR & DTF TEST GUIDE

VSWR / LOSS Test Selection

1. From the Main Menu Select **Test Functions**.
2. From the Functions Menu select **RF Tools**.
3. From the RF Tools Menu select **VSWR/LOSS**.
4. The VSWR / LOSS screen is now displayed.

VSWR / LOSS Test Screens



VSWR test screen.



S21 Loss measurement.

VSWR / LOSS Test Controls & Indicators

Item	Description
<div style="display: flex; gap: 10px;"> <div style="background-color: #28a745; color: white; padding: 5px; border-radius: 5px;">VSWR</div> <div style="border: 1px solid #ccc; padding: 5px; border-radius: 5px;">Loss S21</div> </div>	Chart selection between VSWR measurement and S21 Loss measurement.
Frequency Range	Start & End frequencies of sweep.
Frequency (Datapoint)	Frequency of datapoint selected on chart.
VSWR (Datapoint)	VSWR value of datapoint selected on chart.
Loss (Datapoint)	Loss measured across Ports 1 & 2.

VSWR / LOSS Test Operation

For VSWR measurements:



VSWR Setup with connection to Port 1

1. Connect cable or device under test to **Port 1** - **S11** of ARTS 7000 VSWR Module.
2. Select the appropriate **Frequency Range** in the ARTS 7000 application to run a frequency sweep.
3. Press **Start Test** to begin sweep.

For S21 Gain/Loss measurements:



S21 Gain/Loss Setup with connections to Port 1 & Port 2

1. Connect one end of cable or device under test to **Port 1 - S11** and return end of cable to **Port 2 - S21** of ARTS 7000 VSWR Module. This will measure the gain/loss across cable or device under test.
2. Select the appropriate **Frequency Range** in the ARTS 7000 application to run a frequency sweep.
3. Press **Start Test** to begin sweep.

SECTION 30: DISTANCE TO FAULT

SUBSECTION 1: DISTANCE TO FAULT OPERATION

The ARTS 7000 Test System can be configured with a VSWR + Distance to Fault (DTF) module. This module can assist in diagnosing issues in the signal path due to shorts, reflections, or unexpected signal loss. The module performs a sweep across user-defined frequencies and returns an approximate distance to any perceived fault.

WARNING

It is extremely dangerous to generate signals during testing that are on the frequencies that are in use by local ATC. When operating the Test Set, please be aware of the local ATC frequencies. It is the test set operator's responsibility to make sure all testing is carried out on frequencies that will not interfere with local navigational aids or ATC resources.

Please See Appendix A for technical specifications.

Test Hardware Required

Item	Test Type	Description / Notes	Part Number
ARTS-7000 VSWR + DTF Module	Module	Module for ARTS-7000.	115-2049
Coax Cable option of 6, 20 or 60 ft (optional)	Dir – Cable	Operator choice to connect to unit under test.	VARIOUS

SUBSECTION 2: DTF TEST GUIDE

DTF Test Selection

1. From the Main Menu Select **Test Functions**.
2. From the Functions Menu select **RF Tools**.
3. From the RF Tools Menu select **DTF**.
4. The Distance to Fault screen is now displayed.

DTF Test Configuration Screen

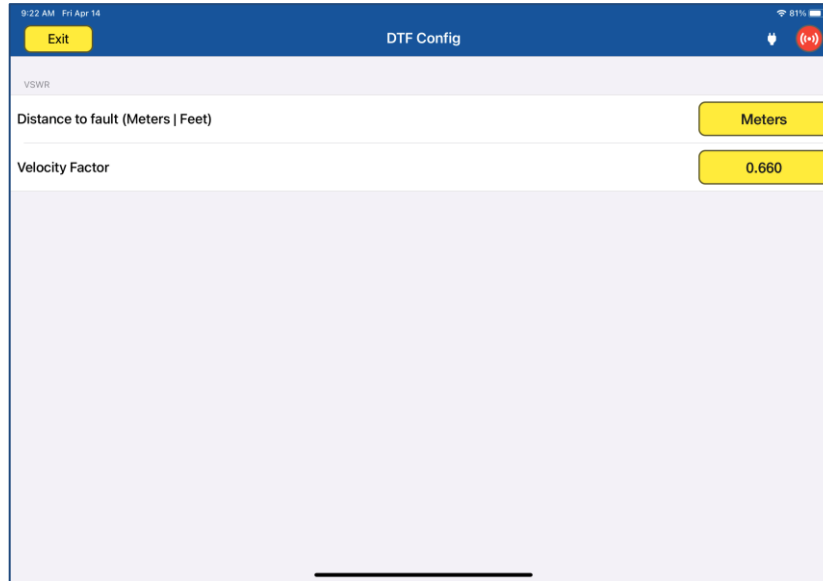

DTF Configuration screen.

DTF Test Configuration Controls and Selections

Item	Description
Distance to fault (Meters Feet)	Selects unit of measurement for distance to fault result.
Velocity Factor	Speed of transmission through cable (Default: polyethylene-based cable with Velocity factor of 0.660)

DTF Test Screens



DTF test screen.

DTF Test Controls & Indicators

Item	Description
Frequency Range	Start & End frequencies of sweep.
Peak (Distance)	Distance corresponding to peak value measured.
Distance (Datapoint)	Distance of user-selected datapoint on chart.

DTF Test Operation

For Distance to fault measurements:



VSWR Setup with connection to Port 1

1. Connect cable or device under test to **Port 1** – **s11** of ARTS 7000 VSWR Module.
2. Select the appropriate **Frequency Range** in the ARTS 7000 application to run a frequency sweep.
3. Press **Start Test** to begin sweep.

SECTION 31: TEST TOOLS

SUBSECTION 1: TEST TOOLS DESCRIPTION

The ARTS 7000 Test Application includes diagnostic test tools to help identify tuning errors, antenna issues, unstable transmitters, transmitters with drift, and verification checks for received frequencies and power. The Test Tools can be used at any time, but they may be most helpful when the ARTS is unable to display “received” Frequency or Power values.

SUBSECTION 2: COUNTER & METER

WARNING

It is extremely dangerous to generate signals during testing that are on the frequencies that are in use by local ATC. When operating the Test Set in COM Mode please be aware of the local COM ATC frequencies. It is the test set operator’s responsibility to make sure all testing is carried out on frequencies that will not interfere with local navigation aids or ATC resources.

Please See Appendix A for technical specifications.

Test Hardware Required

Item	Test Type	Description / Notes	Part Number
Nav Com Antenna	Ant - Ant	Telescopic wide frequency band antenna.	123-0239
Antenna Tripod Adapter	Ant - Ant	Optional – Only required for remote ARTS 7000 to antenna connection.	116-0349
Tripod	Ant - Ant	Optional – Only required for remote ARTS 7000 to antenna connection.	118-2286
Coax Cable option of 6, 20 or 60 ft	Ant – Ant Direct Cable	Ant - Ant Optional – Only required for remote ARTS 7000 to antenna connection. Dir - Cbl – operator choice of length recommended to use shortest possible.	VARIOUS

Counter & Meter Test Selection

5. From the Main Menu Select **Test Functions**.
6. From the Functions Menu select **Tools**.
7. From the Tools menu select **Counter & Meter**.
8. The Counter & Meter test Screen is now displayed.

Counter & Meter Test Configuration Screen

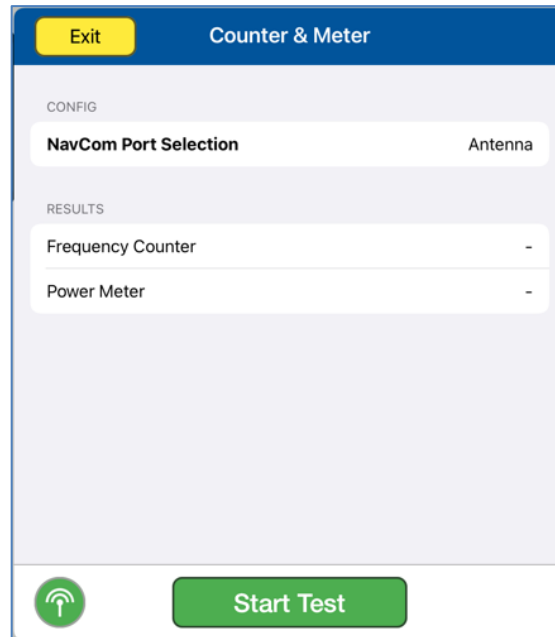

Counter & Meter Test Configuration Controls and Selections

Item	Description
NavCom Port Selection (Cable/Antenna)	Selects the over the air (Antenna) connection Port or the Direct (Cable) Connection Port on the NavCom module.

Counter & Meter Results

Item	Description
Frequency Counter	Measured frequency of aircraft radio transmission. See details below.
Power Meter	Measured peak power of aircraft radio transmission. See details below.

Frequency Counter Details

The Counter measures the transmitted frequency from the Aircraft Radio. The counter has a wider band than the Main ARTS NavCom receiver.

1. If many frequencies are received the reading may fluctuate and not be useful.
2. If the received frequency is stable, this will be useful for comparison to the NavCom frequency tests. If the Aircraft Radio is good the counter frequency and test page frequency should match.
3. If the counter frequency is not displayed, verify that the aircraft radio is tuned correctly. If it is tuned correctly, the aircraft radio may have instability or frequency drift and is most likely unserviceable.

Power Meter Details

The Power meter value indicates the peak power of the received signal. It is only meaningful if the Frequency Counter value is stable. The Peak Power value will typically be higher than the received Power value in the COM tests by 0 to 6 dB, depending on the percent modulation.

The higher the modulation, the larger the difference.

SUBSECTION 3: FREQUENCY SCANNER

WARNING

It is extremely dangerous to generate signals during testing that are on the frequencies that are in use by local ATC. When operating the Test Set in COM Mode please be aware of the local COM ATC frequencies. It is the test set operator's responsibility to make sure all testing is carried out on frequencies that will not interfere with local navigation aids or ATC resources.

Please See Appendix A for technical specifications.

Test Hardware Required

Item	Test Type	Description / Notes	Part Number
Nav Com Antenna	Ant - Ant	Telescopic wide frequency band antenna.	123-0239
Antenna Tripod Adapter	Ant - Ant	Optional – Only required for remote ARTS 7000 to antenna connection.	116-0349
Tripod	Ant - Ant	Optional – Only required for remote ARTS 7000 to antenna connection.	118-2286
Coax Cable option of 6, 20 or 60 ft	Ant – Ant Direct Cable	Ant - Ant Optional – Only required for remote ARTS 7000 to antenna connection. Dir - Cbl – operator choice of length recommended to use shortest possible.	VARIOUS

Counter & Meter Test Selection

1. From the Main Menu select **Test Functions**.
2. From the Functions Menu select **Tools**.
3. From the Tools menu select **Frequency Scanner**.
4. The Frequency Scanner test Screen is now displayed.

Frequency Scanner Test Configuration Screen

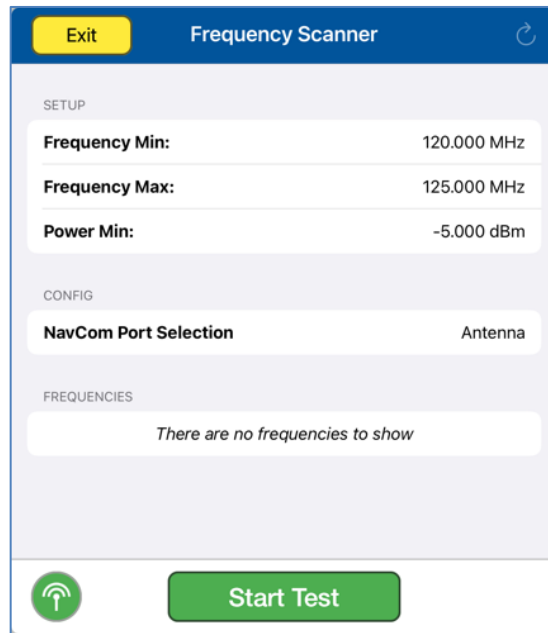

Frequency Scanner Test Configuration Controls and Selections

Item	Description
Frequency Min	Select starting frequency to begin frequency sweep.
Frequency Max	Select ending frequency to end frequency sweep.
Power Min	Set minimum power level to trigger a result.
NavCom Port Selection (Cable/Antenna)	Selects the over the air (Antenna) connection Port or the Direct (Cable) Connection Port on the NavCom module.

Counter & Meter Results

Item	Description
Frequencies	Returns frequencies and respective power values detected during frequency sweep.

Frequency Scanner Details

When configured, the frequency scanner will perform a frequency sweep across a defined range to detect and report the presence of signal above the configured minimum power threshold.

SECTION 32: CALIBRATION

SUBSECTION 1: CALIBRATION NOTIFICATION



ARTS-7000 CALIBRATION NOTIFICATION

Dear ARTS-7000 Customer,

The Laversab ARTS-7000 requires an annual calibration to ensure the adherence to the accuracy specifications. This calibration is to be performed by a Laversab Authorized Service Center with the appropriate equipment and software.

The ARTS-7000 application will notify the user when the unit is nearing the calibration due date.

While the ARTS-7000 can be used if the calibration period has lapsed, it may not perform in line with the listed specifications.

Please contact your Laversab representative or a Laversab Authorized Service Center for more information.



Chandrashekar Nilekani
Quality Assurance Manager – Laversab, Inc.

This page is intentionally left blank.

APPENDIX A: TECHNICAL SPECIFICATIONS

Capability	ARTS Function	Attribute	Values	Resolution	Accuracy
Battery		Battery Life	>8 hours	N/A	N/A
		Removable Battery	Yes	N/A	N/A
		Battery Voltage	28 VDC	N/A	N/A
Power requirement		Input Power AC	90 to 260 VAC @47-400 Hz	N/A	N/A
		Input Power DC	28 VDC	N/A	N/A
Environmental		Storage Temperature	-30 to 75°C	N/A	N/A
		Operational Temperature	-20 to 60°C	N/A	N/A
		Relative Humidity Maximum	95 %	N/A	N/A
Dimensions and Weights		Height	9.5 in / 24 cm	N/A	N/A
		Width	22 in / 56 cm	N/A	N/A
		Depth	14 in / 35.5 cm	N/A	N/A
		Weight Test Set with Battery	26 lbs / 11.8 kg	N/A	N/A
		Weight Test Set without Battery	24 lbs / 10.8 kg	N/A	N/A
Nav and Com Functions	Transmitter / Receiver	Frequency Range	10 to 410 MHz		
		Frequency Steps	1, 8.33, 25, 50 kHz (mode dependant)		
		Frequency Accuracy	0.1 ppm		
		Output Power (Antenna port)	-83 to 13 dBm	0.25 dB	±2 dB
		Output Power (Cable port)	-110 to -14 dBm	0.25 dB	±2 dB
FM	Transmitter / Receiver	Com FM Frequency Range	10 to 410 MHz		0.1 ppm
		Com FM Frequency Steps	1, 12.5, 25 kHz (mode dependent)		
		Com FM Power Range (Antenna port)	-83 to 13 dBm	0.25 dB	±2 dB
		Com FM Power Range (Cable port)	-110 to -14 dBm	0.25 dB	±2 dB
		Com FM Ident	Morse (LSB) or 1 kHz tone		
		Com FM Audio Tone	1020 Hz		±0.5%
		Com FM Com Deviation at Preset	200 Hz		
Com FM Deviation Range	0 to 15 kHz	1 Hz			

		Com Preset Test Frequencies	156.000, 165.000, 174.000 MHz		
		Com FM User entry Preset Test Frequencies	User defined		
AM	Transmitter / Receiver	Com AM Frequency Range	10 to 400 MHz		0.1 ppm
		Com AM Frequency Steps	1 or 8.3 or 25 kHz (mode dependant)		
		Com AM Power Range (Antenna port)	-83 to 13 dBm	0.25 dB	±2 dB
		Com AM Power Range (Cable port)	-110 to -14 dBm	0.25 dB	±2 dB
		Com AM Audio Tone	1020 Hz		±0.5%
		Com AM Modulation at Preset	30%		±2%
		Com AM Modulation Variable	0 to 95%		
		Com AM Preset Test Frequencies	123.450, 225.000, 312.000 MHz		
		Com AM User Entry Preset Test Frequencies	User defined		
HF SSB	Transmitter / Receiver	Com HF SSB Frequency Range	10 to 30 MHz	1 kHz	±1 Hz
		Com HF SSB Power Range (Antenna port)	-83 to 13 dBm	0.25 dB	±2 dB
		Com HF SSB Power Range (Cable port)	-110 to -14 dBm	0.25 dB	±2 dB
		Com HF SSB Audio Tone	1000 Hz		±0.5%
		Com HF SSB Modulation at Preset	30%		±2%
		Com HF SSB Modulation Variable	0 to 95%		
		Com HF SSB USB	25-3000 Hz	25 Hz	
		Com HF SSB LSB	25-3000 Hz	25 Hz	
SELCAL	Transmitter	Com SelCal Frequency Range	10 to 400 MHz	1 kHz	0.1 kHz
		Com SelCal Power Range (Antenna port)	-83 to 13 dBm	0.25 dB	±2 dB
		Com SelCal Power Range (Cable port)	-110 to -14 dBm	0.25 dB	±2 dB
		Com SelCal Modulation Range	0 to 90%		±1%
		Com SelCal Modulation at Preset (per tone)	85%		±2%
		Com SelCal Tone Frequency Accuracy	±0.02%		
		Com SELCAL Transmit function	Single & Continuous		
ILS - LOC	Transmitter	LOC Frequency Range	107 to 113 MHz	1 kHz	1 kHz
		LOC Power Range (Antenna port)	-83 to 13 dBm	0.25 dB	±2 dB
		LOC Power Range (Cable port)	-100 to -14 dBm	0.25 dB	±2 dB

		LOC 90Hz Frequency Accuracy	90 Hz		±0.02%
		LOC 150Hz Frequency Accuracy	150 Hz		±0.02%
		LOC IDENT	1020 Hz		±0.02%
		LOC Modulation at Preset 90 Hz & 150 Hz	20%		±2%
		LOC DDM Range Max Variable	-0.390 to 0.390		±0.005
		LOC DDM Range Max Fixed	-0.200 to 0.200		±0.005
		LOC 90 Hz & 150 Hz Tone Delete	YES		
		LOC Full Automatic sweep of LOC	YES		
		LOC Phase Shift Range	-120 Deg to 120 Deg	1 Deg	±0.5 Deg
		LOC Preset Test Frequencies	108.100, 110.100, 111.950 MHz		
		LOC User Entry Preset Test Frequencies	User defined		
ILS - G/S	Transmitter	G/S Frequency Range	327 to 337 MHz	1 kHz	1 kHz
		G/S Power Range (Antenna port)	-90 to 0 dBm	0.25 dB	±2 dB
		G/S Power Range (Cable port)	-117 to -27 dBm	0.25 dB	±2 dB
		G/S 90 Hz Frequency Accuracy	90 Hz		±0.02%
		G/S 150 Hz Frequency Accuracy	150 Hz		±0.02%
		G/S Modulation at Preset 90 Hz & 150 Hz	20%		±2%
		G/S DDM Range Max Variable	-0.780 to 0.780		±0.005
		G/S DDM Range Max Fixed	-0.780 to 0.780		±0.005
		G/S 90 Hz & 150Hz Tone Delete	YES		
		G/S Full Automatic sweep of G/S	YES		
		Phase Shift Range & Step	-120 Deg to 120 Deg	1 Deg	±0.5 Deg
		Full Automatic sweep of G/S	YES		
		G/S Preset Test Frequencies	330.950, 334.400, 334.700 MHz		
		G/S User Entry Preset Test Frequencies	User defined		
ILS Auto	Transmitter	Continuous Automatic sweep of LOC & GS	Yes		
Marker	Transmitter	MKR Frequency Range	72 to 78 MHz	1 kHz	1 kHz
		MKR Preset Modulation	95%		±5%
		MKR Modulation Range	0 to 95%		±5%
		MKR Inner Frequency	3000 Hz		±0.02%
		MKR Middle Frequency	1300 Hz		±0.02%
		MKR Outer Frequency	400 Hz		±0.02%
ILS & MKR	Transmitter	Combined ILS and MKR	See LOC, G/S and MKR spec		

VOR	Transmitter	VOR Frequency Range	107 to 118 MHz	1 kHz	1 kHz
		VOR Power Range (Antenna port)	-83 to 13 dBm	0.25 dB	±2 dB
		VOR Power Range (Cable port)	-110 to -14 dBm	0.25 dB	±2 dB
		VOR Preset Modulation	30%		±1%
		VOR Modulation Range	0 to 95%	1%	±1%
		VOR 30 Hz Reference Frequency Accuracy			±0.02%
		VOR 9960 Hz Reference Frequency Accuracy			±0.02%
		VOR Modulation at Preset 30 & 9960 Hz	0%		±1%
		VOR 30 & 9960 Hz Modulation Range	0 to 30%	1%	±1%
		VOR Ident	Morse (LSB) or 1000 Hz Tone		
		VOR Bearing Select	To / From		
		VOR Fixed Bearing Range	0 to 360 Deg	10 Deg	±0.1 Deg
		VOR Variable Bearing Range	0 to 360 Deg	0.1 Deg	±0.1 Deg
		VOR Auto	Transmitter	Continuous Automatic sweep of VOR Bearing	Yes
121.5 & 243 MHz Emergency Beacons	Receiver	121.5 / 243 MHz Frequency Range	121.5 and 243 MHz		
		121.5 / 243 MHz Swept Audio Tone Range	100 to 3000 Hz		10%
		121.5 / 243 MHz Sensitivity (Antenna port)	>-35 dBm		
		121.5 / 243 MHz Sensitivity (Cable port)	>-10 dBm		
406 MHz Emergency Beacon	Receiver	406 MHz Sensitivity (Antenna port)	>-35 dBm		
		406 MHz Sensitivity (Cable port)	>-10 dBm		
		406 MHz Short and Long message decode	Yes		
		406 MHz Test Results Saved	Yes		

Capability	ARTS Function	Attribute	Values	Resolution	Accuracy
Pulse Functions	Transmitter / Receiver	Frequency Range	960 to 1220 MHz	1 MHz	±10 kHz
		Output Power Range (Antenna port)	-67 to -2 dBm	0.25 dB	±2 dB
		Output Power Range (Cable port)	-100 to -29 dBm	0.25 dB	±2 dB
DME MODE	Transmitter	Frequency Range	962 to 1213 MHz	1 MHz	±10 kHz
		Output Power Range (Antenna port)	-67 to -2 dBm	0.25 dB	±2 dB
		Distance ARTS Antenna to Aircraft Antenna	3 to 225 ft	1 ft	±1 ft
		Output Power Range (Cable port)	-94 to -29 dBm	0.25 dB	±2 dB
		Reply Delay X Channel 1st Pulse	50 µs		±100 ns
		Reply Delay Y Channel 1st Pulse	56 µs		±100 ns
		Reply Delay X and Y Channel 2nd Pulse	50 µs		±100 ns
		Reply Pulse Width P1/P2	3.5 µs		±0.5 us
		P1 to P2 Reply Pulse Spacing X channel	12 µs		±100 ns
		P1 to P2 Reply Pulse Spacing Y channel	30 µs		±100 ns
		Reply Pulse Rise Time	2.5 µs		±0.25 us
		Reply Pulse fall time	2.5 µs		±0.25 us
		Squitter PRF	2700 Hz		±2%
		Squitter Distribution	IAW ARINC 568		
		Simulated DME Range X and Y Channel	0 to 450 nmi	0.01 nmi	±0.01 nmi
		Simulated DME Rate X and Y Channel	0 to 6000 kts	1 kt	±0.1%
		Echo Reply	ON/OFF		
		Echo Reply Position	30 nmi		±1 nmi
		Echo Reply Amplitude	-11 dBm		±2 dB
		Reply Efficiency Range	0 to 100%	1%	±0.5%
	Ident Audio Tone or Morse	Selection			
	Audio Ident Tone	1000 Hz		±2 Hz	
	Morse Tone	Morse identifier (LSB) 1000 Hz			
	UUT Measure	ERP	+47 to +67 dBm	0.1 dB	±2 dB
		Peak Pulse Power Direct	+47 to +64 dBm	0.1 dB	±2 dB
		Frequency Range	1025 to 1150 MHz	10 kHz	±20 kHz
		Interrogation Pulse Width P1 and P2	2.00 to 5.00 µs	25 ns	±50 ns
		Interrogation Pulse Spacing P1 to P2 X Channel	10 to 14 µs	25 ns	±25 ns
		Interrogation Pulse Spacing P1 to P2 Y Channel	34 to 38 µs	25 ns	±25 ns
		Interrogation PRF	1 to 300 Hz	1 Hz	±2 Hz

DME & ILS		Combined DME and ILS	See DME and LOC/GS for specifications		
DME & VOR		Combined DME and VOR	See DME and VOR for specifications		
Transponder	Interrogation Transmitter	Interrogation Frequency	1030 MHz		±10 kHz
		Antenna Connector Power	MTL +6 dBm (when automatically controlled)	0.25 dB	±2 dB
		Output Power Range (Antenna port)	-67 to -2 dBm	0.25 dB	±2 dB
		Distance ARTS Antenna to Aircraft Antenna	3 to 225 ft	1 ft	1 ft
		Mode A Pulse Spacing P1 to P2	2.00 µs		±25 ns
		Mode A Pulse Spacing P1 to P3	8.00 µs		±25 ns
		Mode C Pulse Spacing P1 to P2	2.00 µs		±25 ns
		Mode C Pulse Spacing P1 to P3	21.00 µs		±25 ns
		Mode S Pulse Spacing P1 to P2	2.00 µs		±25 ns
		Mode S Pulse Spacing P1 to P6	3.50 µs		±25 ns
		Mode S Pulse Spacing P1 to SPR	4.75 µs		±25 ns
		Mode S Pulse Spacing P5 to SPR	0.40 µs		±25 ns
		Intermode Pulse spacing Mode A P1 to P3	8.00 µs		±25 ns
		Intermode Pulse spacing Mode A P1 to P4	10.00 µs		±25 ns
		Intermode Pulse spacing Mode C P1 to P3	21.00 µs		±25 ns
		Intermode Pulse spacing Mode C P1 to P4	23.00 µs		±25 ns
		Interrogation Pulse width A, C, S, Intermode p1,p2,p3	0.80 µs		±50 ns
		Interrogation Pulse width Mode S P6 SHORT	16.25 µs		±50 ns
		Interrogation Pulse width Mode S P6 long	30.25 µs		±50 ns
		Interrogation Pulse width Mode S P5	0.80 µs		±50 ns
		Interrogation Pulse width Intermode P4 short	0.80 µs		±50 ns
		Interrogation Pulse width Intermode P4 long	1.60 µs		±50 ns
		Interrogation Pulse Rise Time All Modes	50 to 100 ns		
		Interrogation Pulse Fall Time All Modes	50 to 200 ns		
		Phase Modulation all Modes Transition Time	<80 ns		
Phase Modulation all Modes Phase Shift	180 Deg		±10 Deg		

		SLS Level ATCRBS P2	-10 dB to -9 dB relative to P1 level (not suppressed) 0 dB to +1 dB relative to P1 level (suppressed)		
		SLS Level Mode S P5	-13 dB to -12 dB relative to P1 level (not suppressed) 0 dB to +1 dB relative to P1 level (suppressed)		
		Mode S Interrogation PRF	50 Hz		±5 Hz
		ATCRBS Interrogation PRF	235 Hz		±5 Hz
	UUT Measure	Frequency	1087 to 1093 MHz	10 kHz	±50 kHz
		Receiver Sensitivity for MTL	-79 to -67 dBm	0.1 dB	±2 dB
		ERP Power Range @ 1090	+45.5 to +59 dBm	0.1 dB	±2 dB
		Direct Power Range @ 1090	+45.5 to +59 dBm	0.1 dB	±2 dB
		Reply Delay ATCRBS	1.80 to 7.00 µs	25 ns	±25 ns
		Reply Delay Mode S and ATCRBS, All call	125.00 to 131.00 µs	25 ns	±25 ns
		Reply Delay Jitter Range ATCRBS	0.00 to 2.30 µs	25 ns	±25 ns
		Reply Delay Jitter Range Mode S and ATCRBS, All call	0.00 to 6.00 µs	25 ns	±25 ns
		Pulse Spacing F1 to F2	19.70 to 21.60 µs	25 ns	±25 ns
		Pulse Spacing Mode S Preamble pP1 to P2	0.80 to 1.2 µs	25 ns	±25 ns
		Pulse Spacing Mode S Preamble pP1 to P3	3.3 to 3.7 µs	25 ns	±25 ns
		Pulse Spacing Mode S Preamble pP1 to P4	4.3 to 4.7 µs	25 ns	±25 ns
		Pulse Width F1 to F2 Range	0.25 to 0.75 µs	25 ns	±25 ns
		Pulse Width Mode S Preamble	0.25 to 0.75 µs	25 ns	±25 ns
		Pulse Amplitude Variation Mode S	-3 to 3 dB	0.1 dB	±0.5 dB
		Pulse Amplitude Variation ATCRBS	-3 to 3 dB	0.1 dB	±0.5 dB
	DF11 Squitter Period	0.10 to 4.88 sec	10 ms	±10 ms	
Diversity Isolation Range (test range 6ft to 95ft))	0 to >20 dB	0.1 dB	±3 dB		
Test Results Saved automatically	YES				
TCAS Mode	Transmitter	Reply Frequency	1090 MHz		±10 kHz
		Output Power (Antenna port)	-68 dBm at 10 Nmi	0.25 dB	±2 dB
		Distance ARTS Test Antenna to Aircraft Antenna	3 to 225 ft	1 ft	±1 ft
		Output Power (Cable port)	-68 dBm at 10 Nmi	0.25 dB	±2 dB
		Output Power Manual Range Mode (Cable port)	-115 to -47 dBm	0.25 dB	±2 dB
		Reply Pulse Spacing Mode C F1 to F2	20.30 µs		±25 ns
		Reply Pulse Spacing Mode C F1 to C1	1.45 µs		±25 ns

Reply Pulse Spacing Mode C F1 to A1	2.90 μ s		± 25 ns
Reply Pulse Spacing Mode C F1 to C2	4.35 μ s		± 25 ns
Reply Pulse Spacing Mode C F1 to A2	5.80 μ s		± 25 ns
Reply Pulse Spacing Mode C F1 to C4	7.25 μ s		± 25 ns
Reply Pulse Spacing Mode C F1 to A4	8.7 μ s		± 25 ns
Reply Pulse Spacing Mode C F1 to B1	11.60 μ s		± 25 ns
Reply Pulse Spacing Mode C F1 to D1	13.05 μ s		± 25 ns
Reply Pulse Spacing Mode C F1 to B2	14.5 μ s		± 25 ns
Reply Pulse Spacing Mode C F1 to D2	15.95 μ s		± 25 ns
Reply Pulse Spacing Mode C F1 to B4	17.40 μ s		± 25 ns
Reply Pulse Spacing Mode C F1 to D4	18.85 μ s		± 25 ns
Reply Pulse Spacing Mode S P1 to P2	1.00 μ s		± 25 ns
Reply Pulse Spacing Mode S P1 to P3	3.50 μ s		± 25 ns
Reply Pulse Spacing Mode S P1 to P4	4.50 μ s		± 25 ns
Reply Pulse Width Mode C (all Pulses)	0.45 μ s		± 50 ns
Reply Pulse Width Mode S P1 thru P4	0.50 μ s		± 50 ns
Reply Pulse Width Mode S D1 thru D112	0.50 μ s		± 50 ns
Reply Modes	TCAS 1 & 2 Mode C (alt reporting)		
Reply Modes	TCAS 1 & 2 Mode S (Fmt 0,11,16)		
Reply Pulse Amplitude ATCRBS	± 1 db relative to F1		
Reply Pulse Amplitude MODE S	± 1 db relative to P1		
Reply Pulse Rise time All Modes	50 to 100 ns		
Reply Pulse Fall time All Modes	50 to 200 ns		
Percent Reply	0 to 100%	10%	$\pm 1\%$
Reply Delay ATCRBS	3.0 μ s		± 50 ns
Reply Delay Modes S	128 μ s		± 50 ns
Range Delay	0 to 260 nmi	0.1 nmi	± 0.02 nmi
Range Rate	-1200 to +1200 kts	10 kts	10%
Altitude Range	-1000 to 126000 ft	100 ft	25 ft
Altitude Rate	-10000 to +10000 fpm	100 fpm	10%
Squitter Selection	ON / OFF		
Squitter Rate	0.8 to 1.2 s		
Receiver Pulse Spacing ATCRBS S1 to P1	2.0 μ s		± 25 ns
Receiver Pulse Spacing ATCRBS S1 to P1 Accepts	$< \pm 200$ ns		± 25 ns
Receiver Pulse Spacing ATCRBS S1 to P1 Rejects	$> \pm 1.0$ μ s		± 25 ns
Receiver Pulse Spacing ATCRBS P1 to P3	21.0 μ s		± 25 ns

		Receiver Pulse Spacing ATCRBS P1 to P3 Accepts	<±200 ns		±25 ns
		Receiver Pulse Spacing ATCRBS P1 to P3 Rejects	>±1.0 µs		±25 ns
		Receiver Pulse Spacing ATCRBS P1 to P4	23.0 µs		±25 ns
		Receiver Pulse Spacing ATCRBS P1 to P4 Accepts	<±200 ns		±25 ns
		Receiver Pulse Spacing ATCRBS P1 to P4 Rejects	>±1.0 µs		±25 ns
		Receiver Pulse Spacing Mode S P1 to P2	2.0 µs		±25 ns
		Receiver Pulse Spacing Mode S P1 to P2 Accepts	<±200 ns		±25 ns
		Receiver Pulse Spacing Mode S P1 to P2 Rejects	>±1.0 µs		±25 ns
		Receiver Pulse Spacing Mode S P1 to SPR	4.75 µs		±25 ns
		Receiver Pulse Spacing Mode S P1 to SPR Accepts	<±200 ns		±25 ns
		Receiver Pulse Spacing Mode S P1 to SPR Rejects	>±1.5 µs		±25 ns
		Suppression ATCRBS (P2 or S1)	<10%		
		UUT Measure	ERP @ 1030MHz ATCRBS Range (Antenna port)	+43 to +58 dBm	0.1 dB
	ERP @ 1030MHz Mode S Range (Antenna port)		+43 to +58 dBm	0.1 dB	±2 dB
	ERP @ 1030MHz ATCRBS Range (Cable port)		+43 to +58 dBm	0.1 dB	±2 dB
	ERP @ 1030MHz Mode S Range (Cable port)		+43 to +58 dBm	0.1 dB	±2 dB
	Frequency Range		1029.900 to 1030.100 MHz	1 kHz	±10 kHz
	TCAS Interval Range		1.0 to 12.0 sec	0.1 s	±0.2 s

Capability	ARTS Function	Attribute	Values	Resolution	Accuracy
GPS	GPS Simulator	RF Output Level			
		Output Power Range (Direct)	-100 to -145 dBm typical	1 dB	
		Output Power Range (Coupler)	-120 to -165 dBm typical	1 dB	
		Spurious	<-20 dBc over 20 MHz BW <-70 dBc out of band		
		Harmonics	<-140 dBc		
		Master Oscillator			
		10 MHz	Yes		
		Temperature Stability	+/- 75 ppb (0.075 ppm)		
		GPS Signals			
		Static Simulation	Yes		
		Dynamic Simulation	Yes		
		Number of Channels	10		
		Satellite Health States	GOOD / BAD		
		Almanac update	Manual or Automatic file update		
		Maximum Relative Velocity	+/-1166 kts		
		Maximum Relative Acceleration	40 m/s ²		
		Maximum Relative Jerk	1000 m/s ³		
		Maximum Altitude	164,000 ft		
		Pseudo Range Accuracy	0.5 m RMS		
		Pseudo Range Rate Accuracy	Time accuracy 5 ns RMS wrt reference clock		

Capability	ARTS Function	Attribute	Values	Resolution	Accuracy
VSWR & Distance to Fault	VSWR	Frequency range	1 MHz – 1.585 GHz		
		VSWR	< 3:1	0.001	± 0.2, ± 20%
			≥ 3:1	0.001	± 0.3, ± 20%
	Distance to Fault	Distance to fault	0 to 400 ft	0.1 ft	± 0.25 ft ± 5% of scale

APPENDIX B: SPARE PARTS

Item	Description	Part Number
Pulse Antenna	Antenna used for all pulse applications – Large Yellow flat plate antenna.	123-0230
Telescoping Antenna	Antenna used for all Nav, Com and ELT functions	123-0239
Battery Pack	Removable Battery	115-1282
External Battery Charger	Desktop Battery charger (North America plug)	115-1220
Tripod	Used for mounting antenna remotely from the ARTS 7000	118-2286
Antenna Adapter	Used for mounting the Telescoping Antenna onto the tripod for remote operations	116-0349
6ft Coax Cable	Coax Cable	117-0487
20ft Coax Cable	Coax Cable	117-0488
60ft Coax Cable	Coax Cable	117-0489
External Attenuator	Required for direct cable connection (option)	123-0235
Power Cable	Optional ARTS 7000 Power cables	<ul style="list-style-type: none"> i. US Power Cable (6 Feet) [129-1228] ii. UK Power Cable (6 Feet) [129-1328] iii. Europe Power Cable (6 Feet) [129-1268] iv. Swiss Power Cable (6 Feet) [129-1311] v. India Power Cable (6 Feet) [129-1260] vi. China Power Cable (6 Feet) [129-1425] vii. Australia Power Cable (6 Feet) [129-1440]
Accessory Case	Storage case for antenna and cables.	118-1945
Shipping Case	Transit case	118-2253

Appendix C: ARTS-7000 Test Default and Frequency Settings

Test Function	Attribute	Value
ILS	LOC Frequency	110.100 MHz
	GS Frequency	334.400 MHz
	Power LOC	+13.00 dBm
	Power GS	00.00 dBm
	Ident	OFF
	Preset Loc Frequency	110.100, 111.950 MHz & User Defined
MKR	Frequency	75.000 MHz
	Power	-14 dBm
	Modulation	95%
VOR	Frequency	112.200 MHz
	Power	0 dBm
	Modulation	30%
	Ident	OFF
	Preset Frequency	108.200, 112.250, 117.950 MHz & User Defined
Com AM	Frequency	123.450MHz
	Power	0 dBm
	Modulation	30%
	Ident	OFF
	Preset Frequency	123.450, 225.000, 312.000 MHz & User Defined
Com FM	Frequency	165.000 MHz
	Power	0 dBm
	Deviation	200 Hz
	Ident	OFF
	Preset Frequency	156.000, 165.000, 174.000 MHz & User Defined
SSB HF	Frequency	10.000 MHz
	Power	0 dBm

	Sideband	Lower
	Ident	Morse (LSB)
SelCal	Frequency	123.450 MHz
	Power	0 dBm
	Modulation	30%
	SelCal Tone	AAAA
	TX Mode	Repeat
DME	Reply Freq	998.000 MHz
	Nav Freq	110.000 MHz
	Channel	X
	Power	-2 dBm
	Rate KTS	150 Knots
	Range NM	50 NM
	Replies	100%
	Ident	OFF
	SQTR	ON
	ECHO	OFF
	DME Reply Frequency Preset	978.00, 998.00, 1167.00, 1212.00 MHz & User Defined
	DME Nav frequency Preset	108.00, 108.05, 112.20, 112.25, 117.80, 117.85 MHz & User Defined

APPENDIX D: LICENSE ACTIVATION PROCEDURE

This procedure identifies the specific steps required to activate specific software licenses - including TCAS and/or UAT functions – in the ARTS 7000.

SUBSECTION 1: ITEMS REQUIRED

- ARTS-7000 Test System
- ARTS-7000 iPad controller

SUBSECTION 2: ARTS-7000 LICENSE ACTIVATION PROCEDURE

1. Run the ARTS 7000 Application

- a. Open the ARTS 7000 Application.
- b. Press **Offline**.
- c. Enter the **Utilities** Menu and press **Permissions**.

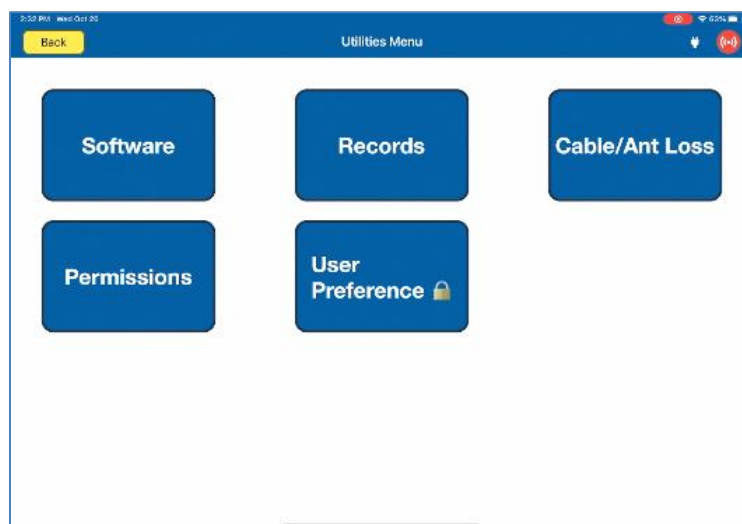
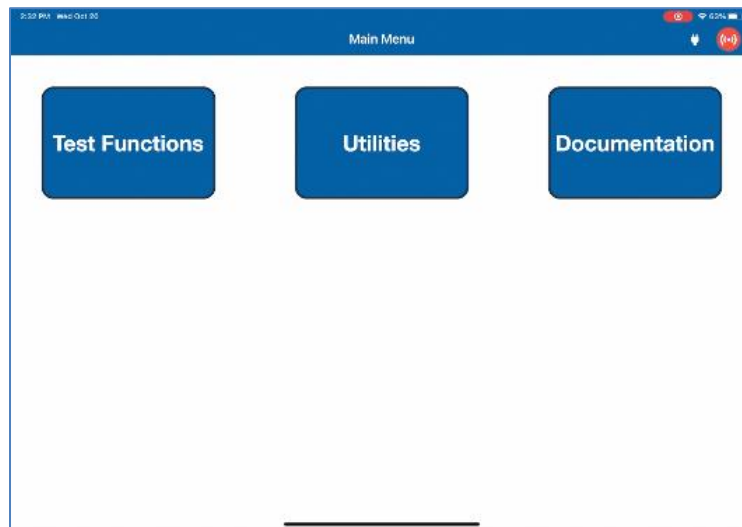

- d. For TCAS: Within the Permissions menu, select **Add TCAS License**, then enter the letters “**LAV**” followed by the Serial Number of the ARTS-7000 unit.
- e. For UAT: Within the Permissions menu, select **Add UAT License**, then enter the letters “**LAV**” followed by the Serial Number of the ARTS-7000 unit.

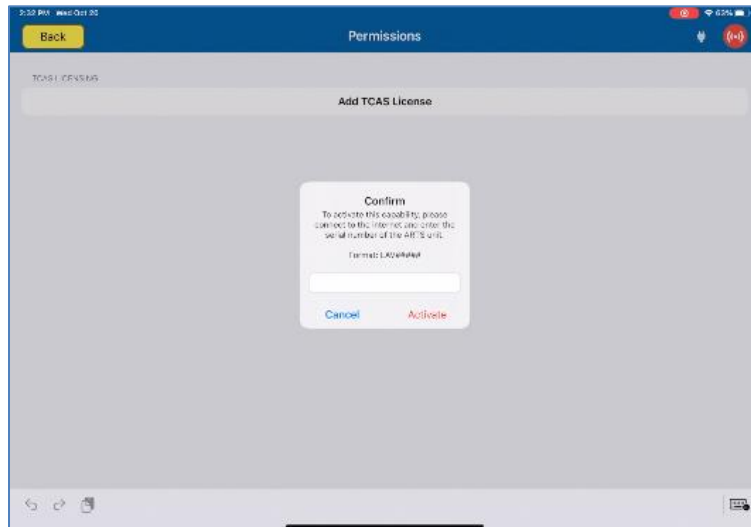

2. License activated.

- a. After verification, the license will be stored on the iPad.
- b. Begin using the TCAS and/or UAT functions after connecting the iPad Wi-Fi to the ARTS-7000 unit.



3. Consult the online video.

- a. Should you have any questions, please review the online video [here](#) to see how the license is activated.